

Relay 1	Lane 3	HAN Kally
-------------------	------------------	------------------

2023 Western Cdn Air Gun	BC	F	WP
--------------------------	----	---	----

14.10.2023	2023 WCAGC Finals AP60W	Alberta Handgun Association
------------	-------------------------	-----------------------------

Comment	Signature
---------	-----------

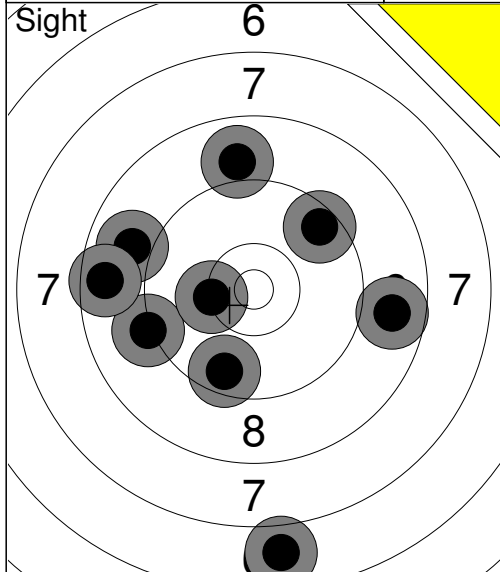

1:	9.6	↘
2:	8.8	→
3:	9.2	←
4:	8.9	←
5:	8.9	↑
6:	8.6	←
7:	10.3	←
8:	9.5	↗
9:	6.8	↘
Series		80.6
		0.0

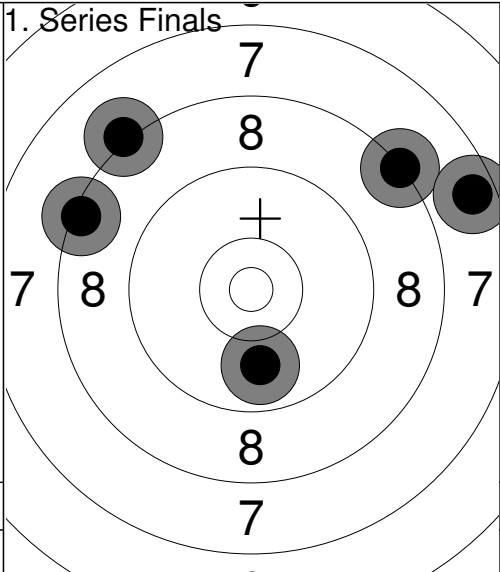

1:	8.2	↗
2:	8.1	↖
3:	9.9	↘
4:	8.3	←
5:	7.6	→
Series		42.1
		42.1

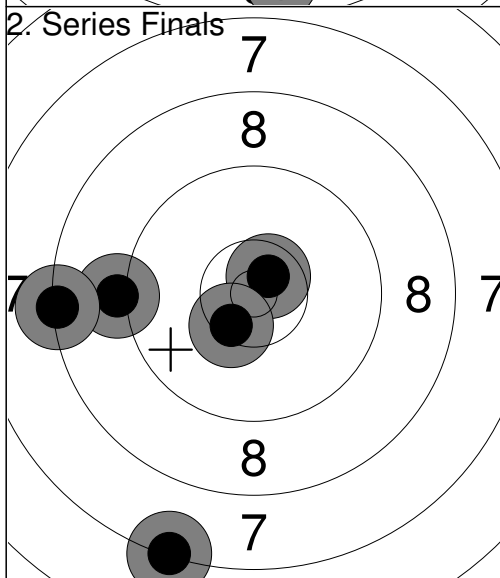

1:	10.6x	↗
2:	7.3	↘
3:	9.1	←
4:	8.3	←
5:	10.4x	↘
Series		45.7
		87.8

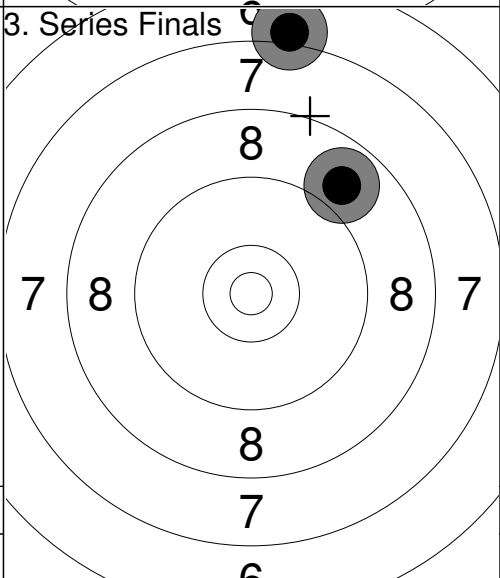

1:	7.0	↑
2:	8.9	↗
Series		15.9
		103.7

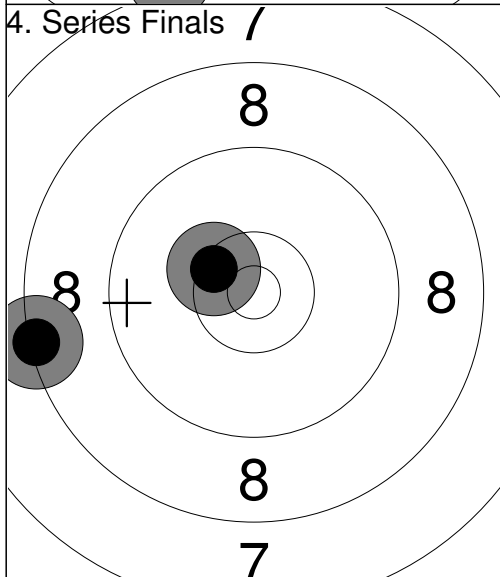

1:	8.3	←
2:	10.4x	↖
Series		18.7
		122.4

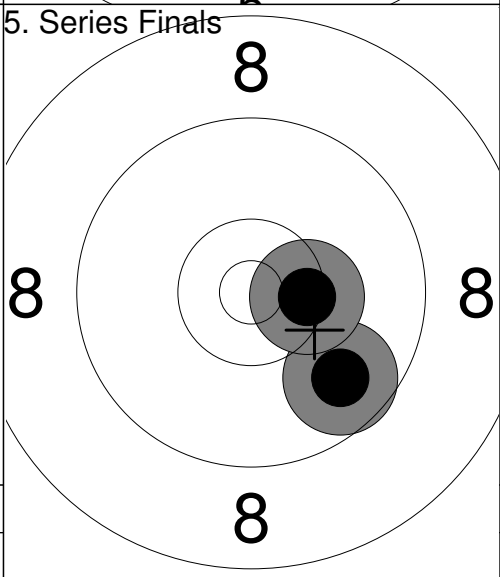

1:	9.7	↘
2:	10.4x	→
Series		20.1
		142.5

Relay 1	Lane 4	<h1>ZHAO Amanda</h1>
-------------------	------------------	----------------------

2023 Western Cdn Air Gun BC	F	WP
-----------------------------	---	----

14.10.2023	2023 WCAGC Finals AP60W	Alberta Handgun Association
------------	-------------------------	-----------------------------

Comment	Signature
---------	-----------

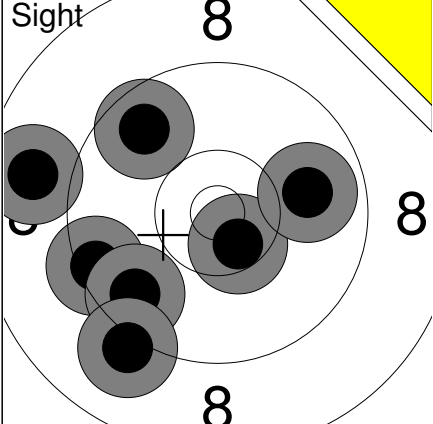
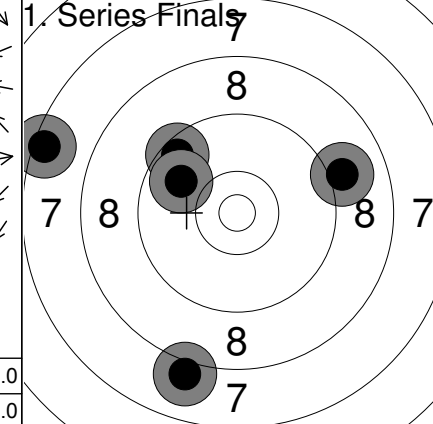
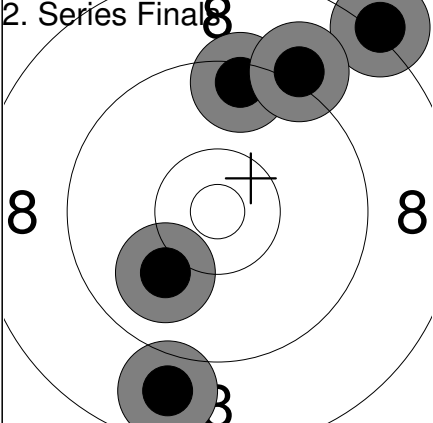
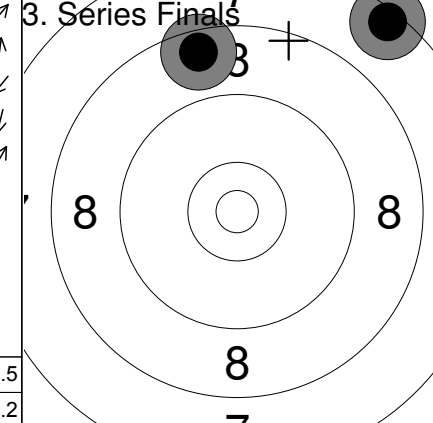
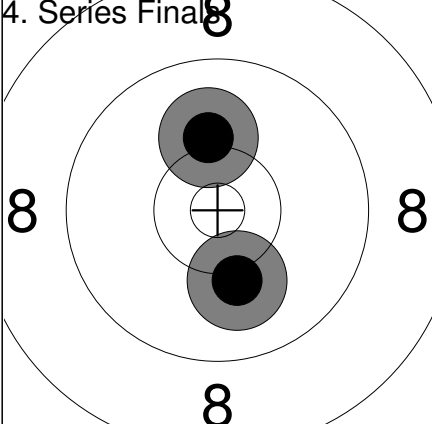
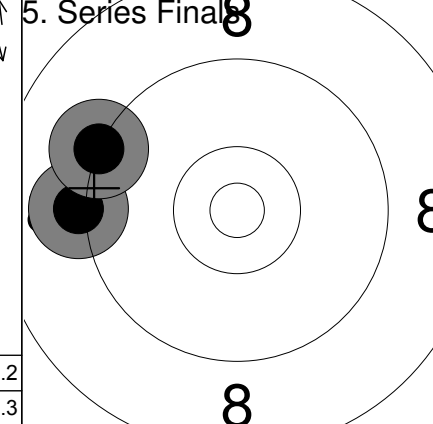
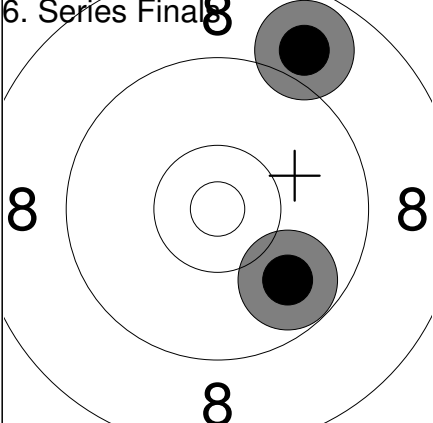
<p>Sight</p> 	<p>1: 10.5x ↘ 2: 9.4 ← 3: 8.8 ↗ 4: 9.7 ↗ 5: 9.9 → 6: 9.6 ↙ 7: 9.1 ↙</p>	<p>1. Series Finals</p> 	<p>1: 8.0 ↘ 2: 7.4 ← 3: 9.0 → 4: 9.5 ↗ 5: 9.8 ↗</p>								
<table style="width:100%; border-collapse: collapse;"> <tr> <td style="width:50%;">Series</td> <td style="text-align: right;">67.0</td> </tr> <tr> <td></td> <td style="text-align: right;">0.0</td> </tr> </table>		Series	67.0		0.0	<table style="width:100%; border-collapse: collapse;"> <tr> <td style="width:50%;">Series</td> <td style="text-align: right;">43.7</td> </tr> <tr> <td></td> <td style="text-align: right;">43.7</td> </tr> </table>		Series	43.7		43.7
Series	67.0										
	0.0										
Series	43.7										
	43.7										
<p>2. Series Finals</p> 	<p>1: 8.1 ↗ 2: 9.5 ↗ 3: 10.0 ↙ 4: 8.8 ↙ 5: 9.1 ↗</p>	<p>3. Series Finals</p> 	<p>1: 8.5 ↑ 2: 7.4 ↗</p>								
<table style="width:100%; border-collapse: collapse;"> <tr> <td style="width:50%;">Series</td> <td style="text-align: right;">45.5</td> </tr> <tr> <td></td> <td style="text-align: right;">89.2</td> </tr> </table>		Series	45.5		89.2	<table style="width:100%; border-collapse: collapse;"> <tr> <td style="width:50%;">Series</td> <td style="text-align: right;">15.9</td> </tr> <tr> <td></td> <td style="text-align: right;">105.1</td> </tr> </table>		Series	15.9		105.1
Series	45.5										
	89.2										
Series	15.9										
	105.1										
<p>4. Series Finals</p> 	<p>1: 10.1 ↑ 2: 10.1 ↘</p>	<p>5. Series Finals</p> 	<p>1: 9.1 ← 2: 9.2 ←</p>								
<table style="width:100%; border-collapse: collapse;"> <tr> <td style="width:50%;">Series</td> <td style="text-align: right;">20.2</td> </tr> <tr> <td></td> <td style="text-align: right;">125.3</td> </tr> </table>		Series	20.2		125.3	<table style="width:100%; border-collapse: collapse;"> <tr> <td style="width:50%;">Series</td> <td style="text-align: right;">18.3</td> </tr> <tr> <td></td> <td style="text-align: right;">143.6</td> </tr> </table>		Series	18.3		143.6
Series	20.2										
	125.3										
Series	18.3										
	143.6										
<p>6. Series Finals</p> 	<p>1: 8.9 ↗ 2: 9.8 ↘</p>										
<table style="width:100%; border-collapse: collapse;"> <tr> <td style="width:50%;">Series</td> <td style="text-align: right;">18.7</td> </tr> <tr> <td></td> <td style="text-align: right;">162.3</td> </tr> </table>		Series	18.7		162.3						
Series	18.7										
	162.3										

Relay **1** Lane **5** **NICOL Sophia ting**

2023 Western Cdn Air Gun BC F WP

14.10.2023 2023 WCAGC Finals AP60W Alberta Handgun Association

Comment Signature

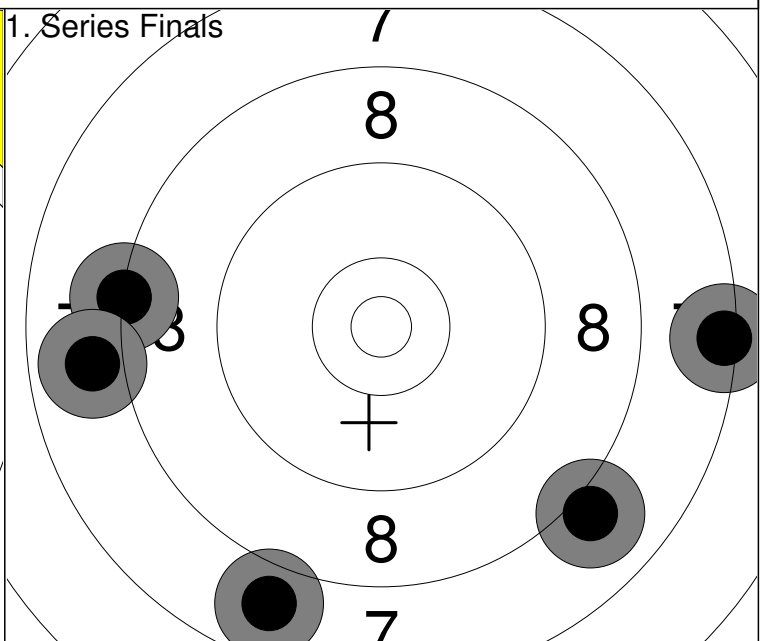
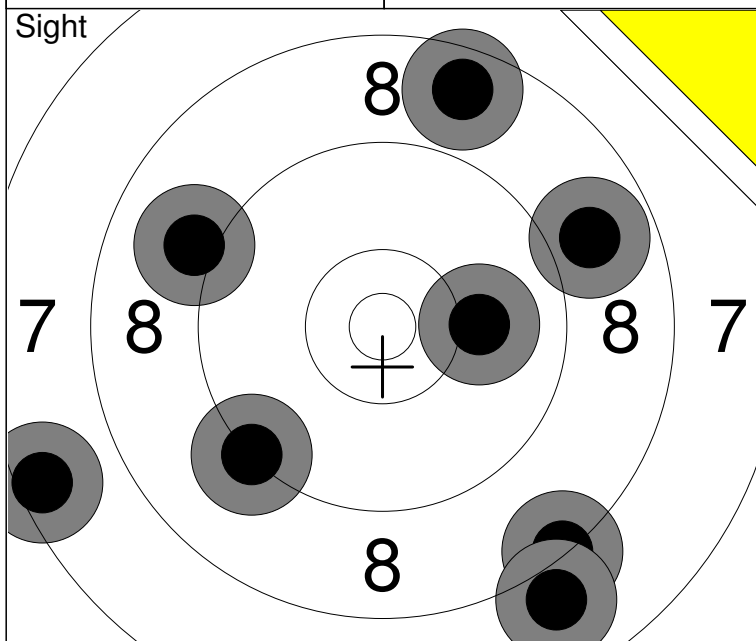

1: 8.3 ↘	6: 9.2 ↙	Series 69.3
2: 10.0 →	7: 7.5 ↙	
3: 7.9 ↘	8: 9.0 ↙	0.0
4: 8.8 →		
5: 8.6 ↗		

1: 7.4 →	Series 39.3
2: 8.0 ↘	
3: 8.2 ←	39.3
4: 7.9 ←	
5: 7.8 ↓	

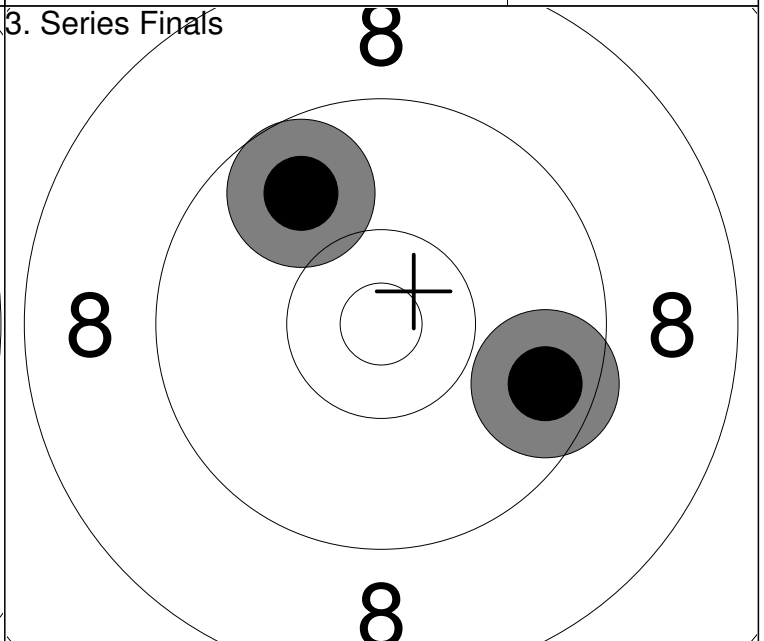
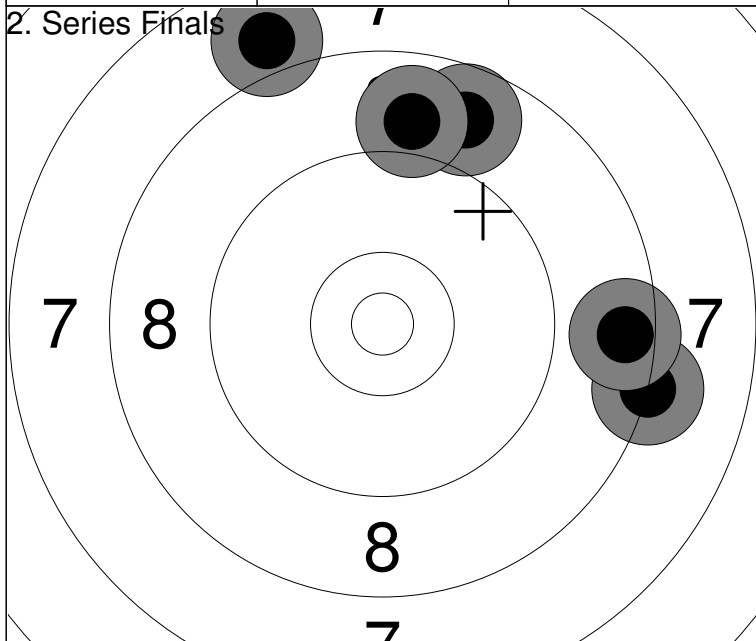

1: 8.2 →	Series 42.3
2: 8.8 ↗	
3: 8.5 →	81.6
4: 7.9 ↗	
5: 8.9 ↗	

1: 9.8 ↗	Series 19.4
2: 9.6 ↘	
	101.0

Relay 1	Lane 6	BRITTON Kim
-------------------	------------------	--------------------

2023 Western Cdn Air Gun AB	F	WP
-----------------------------	---	----

14.10.2023	2023 WCAGC Finals AP60W	Alberta Handgun Association
------------	-------------------------	-----------------------------

Comment	Signature
---------	-----------

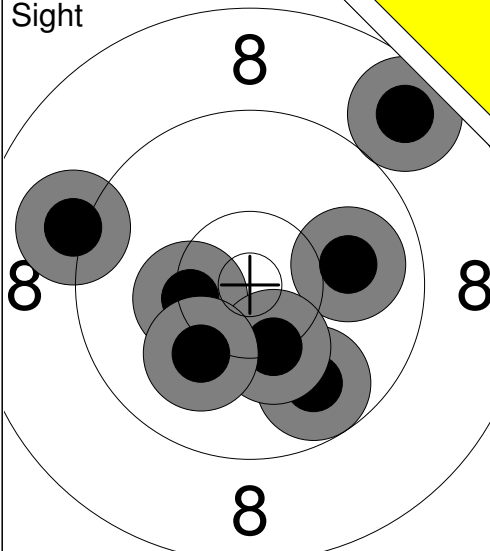
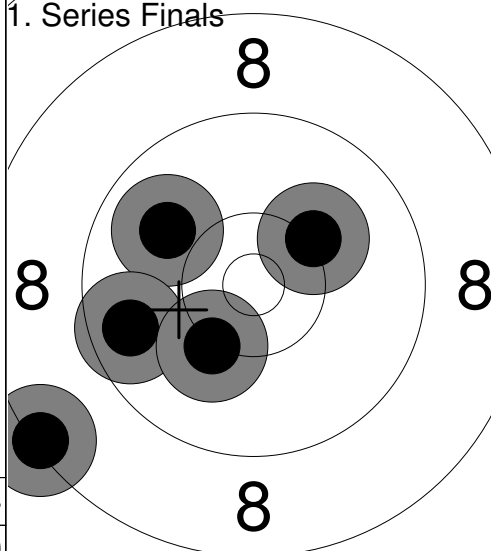
<p>Sight</p> 	<p>1: 8.7 ↗ 2: 9.8 ↓ 3: 10.0 → 4: 10.4 ← 5: 9.1 ← 6: 10.3 ↓ 7: 10.1 ↓</p> <p>Series 68.4 0.0</p>	<p>1. Series Finals</p>  <p>1: 8.3 ↙ 2: 9.9 ↖ 3: 10.2 ↗ 4: 9.6 ← 5: 10.2 ↓</p> <p>Series 48.2 48.2</p>
---	--	--

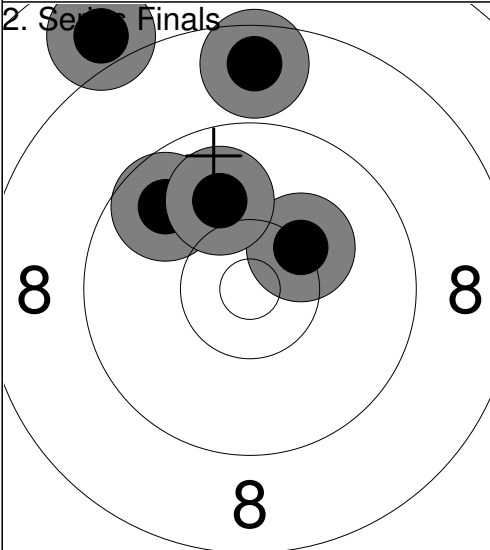
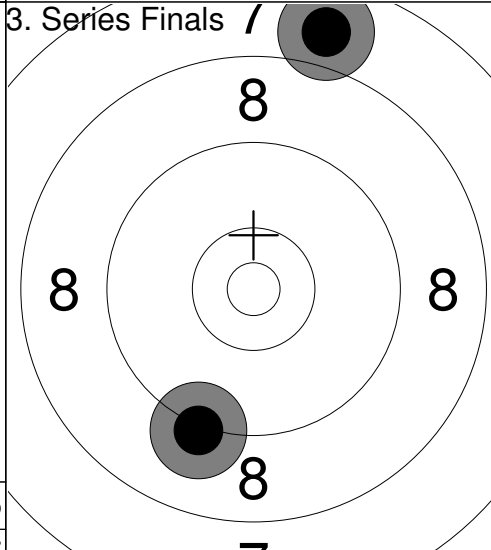
<p>2. Series Finals</p> 	<p>1: 10.3 ↗ 2: 7.9 ↗ 3: 9.7 ↗ 4: 8.6 ↑ 5: 10.0 ↑</p> <p>Series 46.5 94.7</p>	<p>3. Series Finals</p>  <p>1: 9.2 ↓ 2: 7.8 ↑</p> <p>Series 17.0 111.7</p>
---	---	---

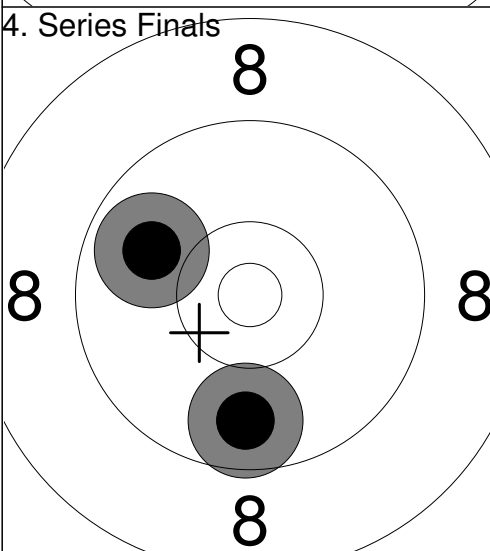
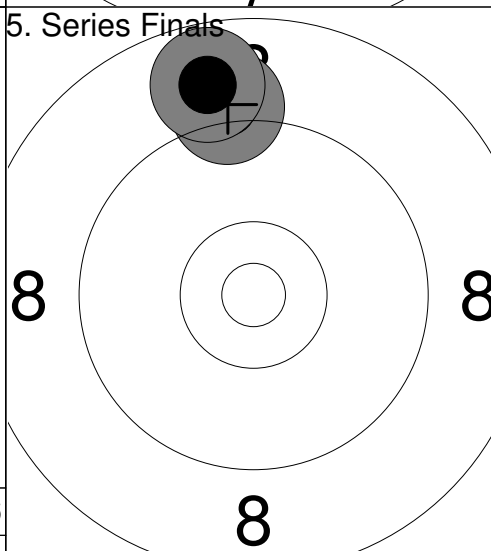
<p>4. Series Finals</p> 	<p>1: 9.9 ← 2: 9.7 ↓</p> <p>Series 19.6 131.3</p>	<p>5. Series Finals</p>  <p>1: 9.1 ↑ 2: 8.8 ↑</p> <p>Series 17.9 149.2</p>
--	---	--

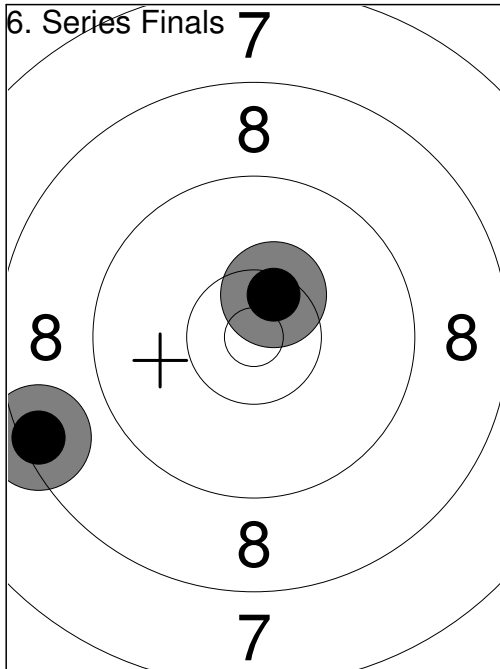

1: 8.4 ↙
2: 10.5x ↗

Series	18.9
	168.1

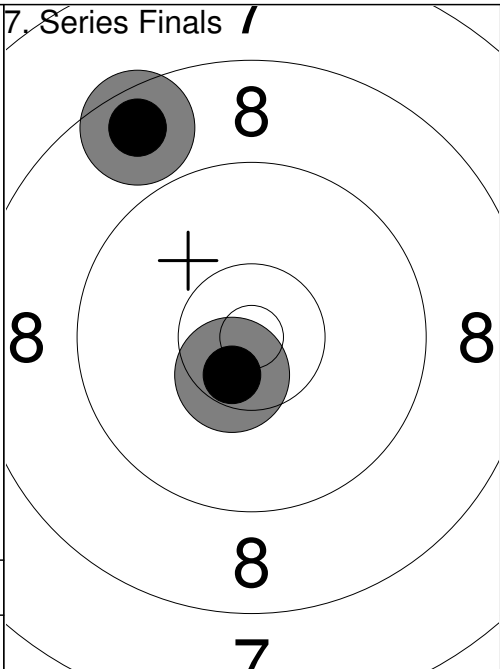

1: 10.5x ↘
2: 8.6 ↖

Series	19.1
	187.2

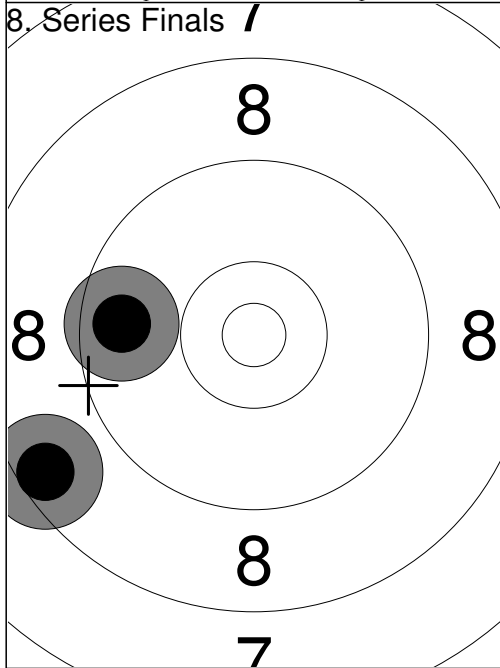

1: 8.5 ↙
2: 9.6 ←

Series	18.1
	205.3

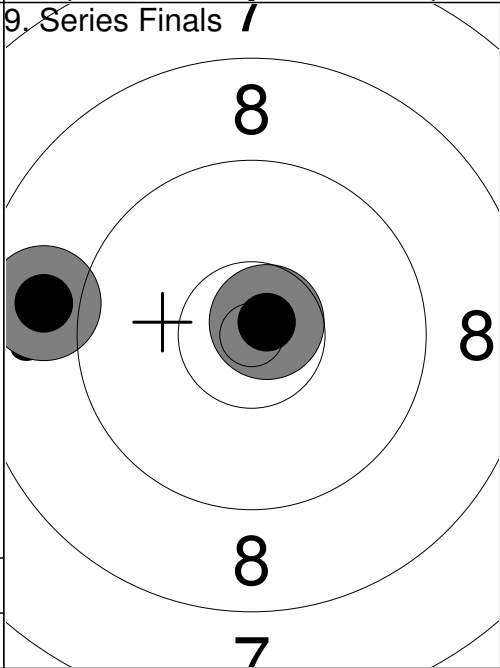

1: 10.8x ↗
2: 8.9 ←

Series	19.7
	225.0

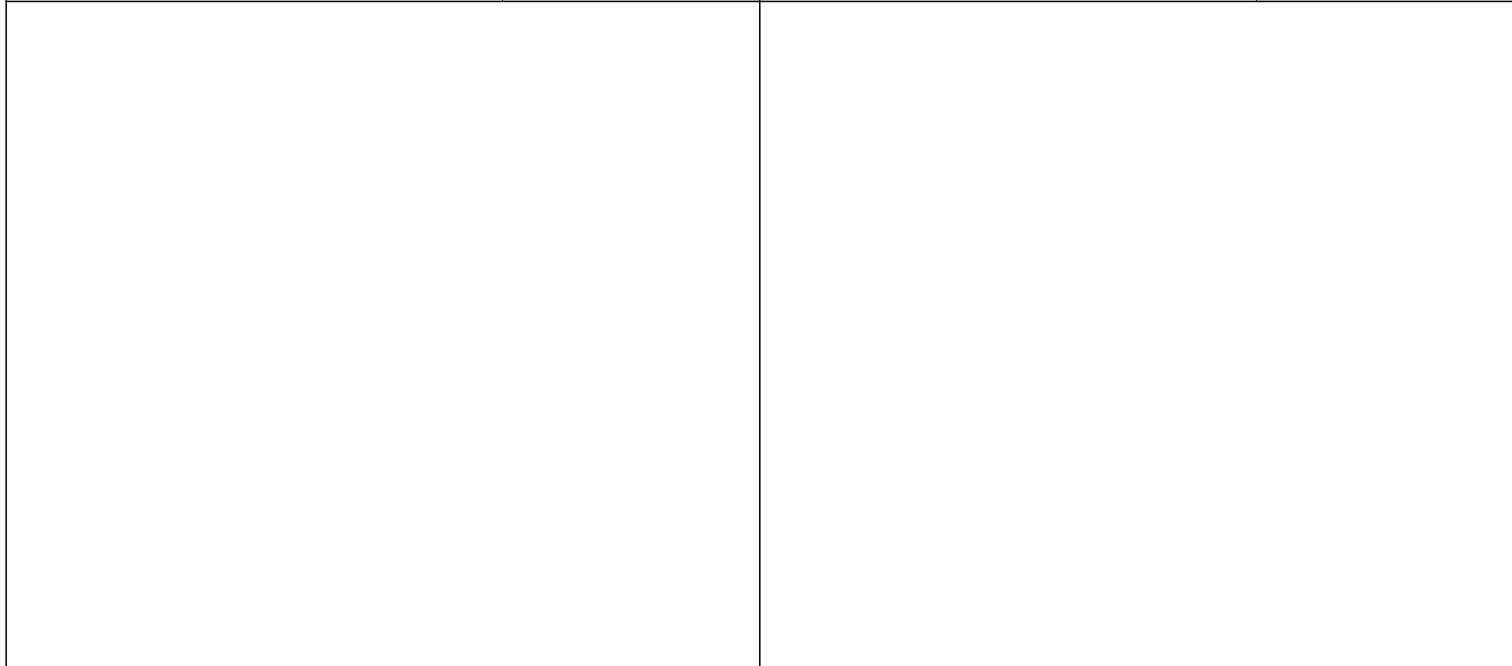

<p>Sight</p>	<p>1: 7.8 ↓ 2: 9.9 ↓ 3: 8.9 ↗ 4: 9.3 ↑ 5: 6.9 ↓ 6: 9.8 ↓ 7: 10.5x ← 8: 9.5 ↓</p>	<p>1. Series Finals</p>	<p>1: 9.9 ↑ 2: 8.9 ↓ 3: 9.1 → 4: 9.6 ↘ 5: 8.7 ↑</p>
Series 72.6		Series 46.2	
0.0		46.2	

<p>2. Series Finals</p>	<p>1: 10.1 ← 2: 10.4x → 3: 8.8 ↓ 4: 8.5 → 5: 9.7 ↑</p>	<p>3. Series Finals</p>	<p>1: 7.9 → 2: 9.8 ↓</p>
Series 47.5		Series 17.7	
93.7		111.4	

<p>4. Series Finals</p>	<p>1: 8.5 → 2: 9.7 ↓</p>	<p>5. Series Finals</p>	<p>1: 9.4 ↗ 2: 9.2 ↖</p>
Series 18.2		Series 18.6	
129.6		148.2	

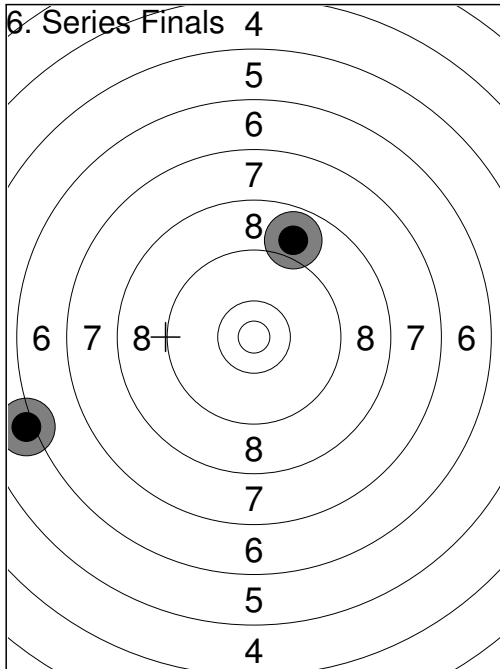

1:	8.9	↗
2:	6.1	←
Series	15.0	
	163.2	

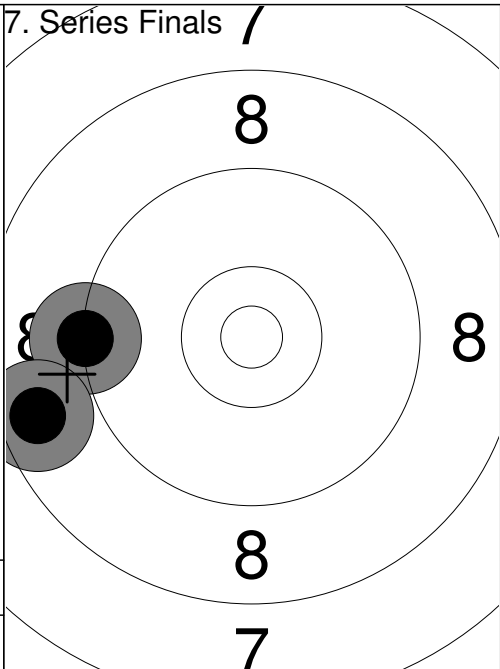

1:	9.3	←
2:	8.6	←
Series	17.9	
	181.1	

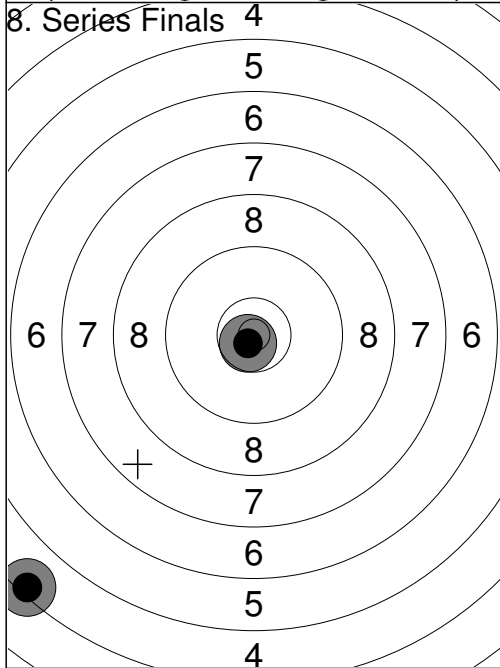

1:	10.8x	↘
2:	4.4	↘
Series	15.2	
	196.3	

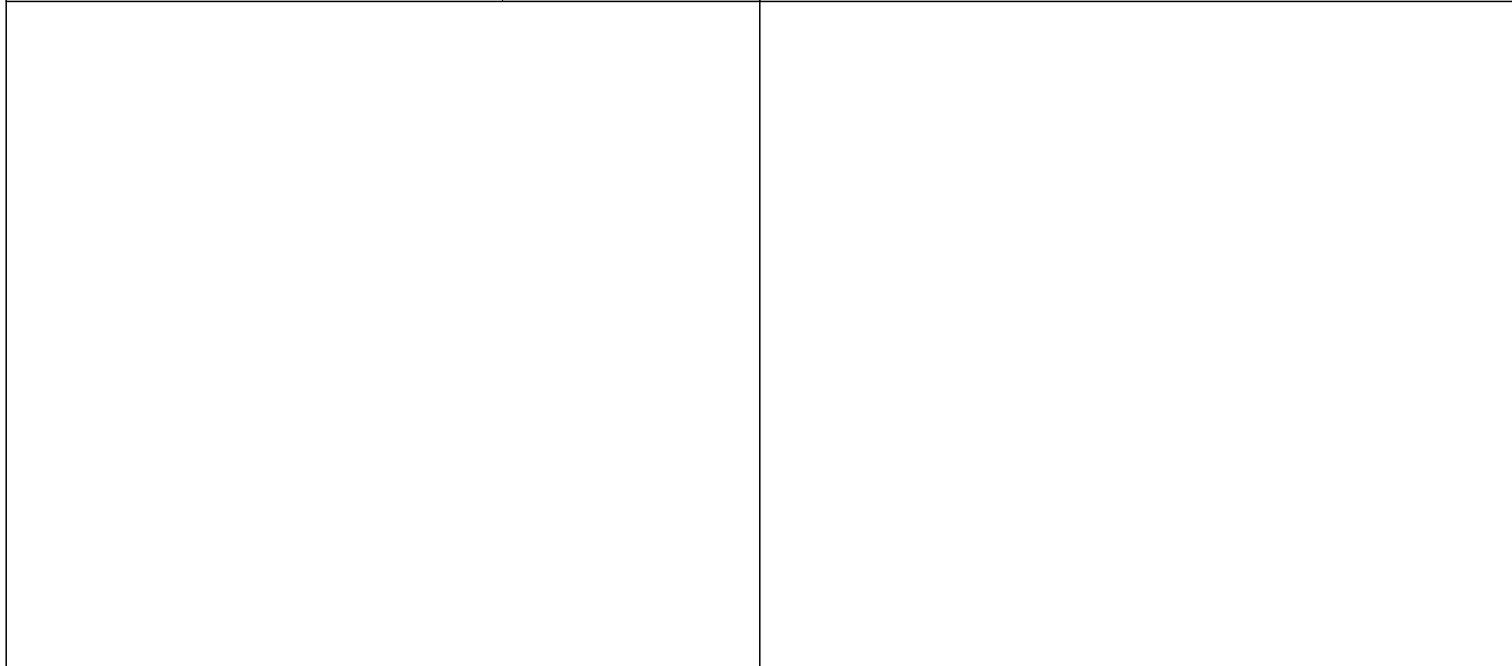

Relay 1	Lane 8	ZHAO Angela
-------------------	------------------	--------------------

2023 Western Cdn Air Gur BC	F	WP
-----------------------------	---	----

14.10.2023	2023 WCAGC Finals AP60W	Alberta Handgun Association
------------	-------------------------	-----------------------------

Comment	Signature
---------	-----------

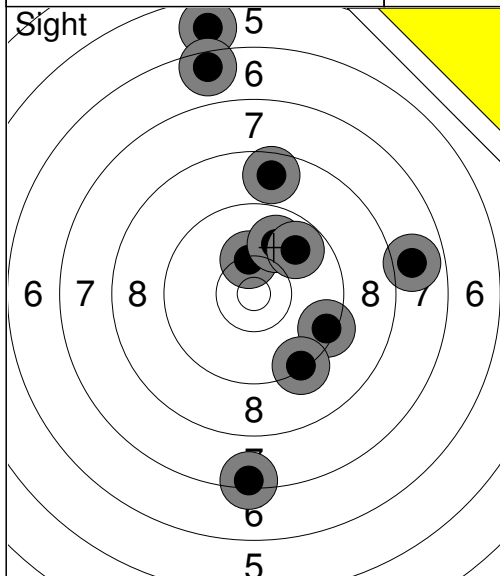

1:	5.8	↑
2:	9.4	→
3:	9.3	↓
4:	10.3	↑
5:	7.9	→
6:	7.4	↓
7:	9.9	↑
8:	8.7	↑
9:	6.5	↑
10:	9.8	↗
Series	85.0	
	0.0	

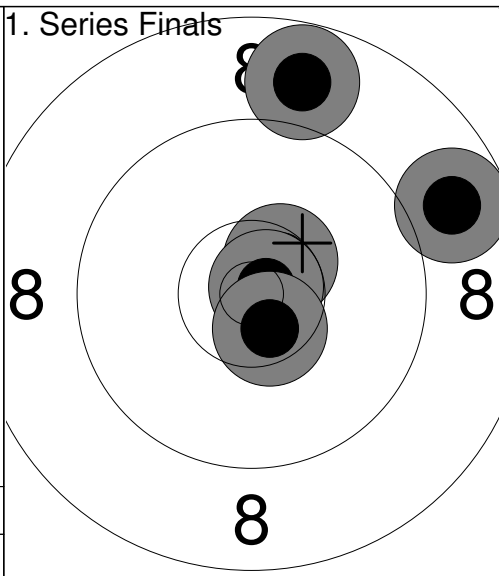

1:	10.5x	↗
2:	10.8x	→
3:	10.6x	↓
4:	8.8	→
5:	8.8	↑
Series	49.5	
	49.5	

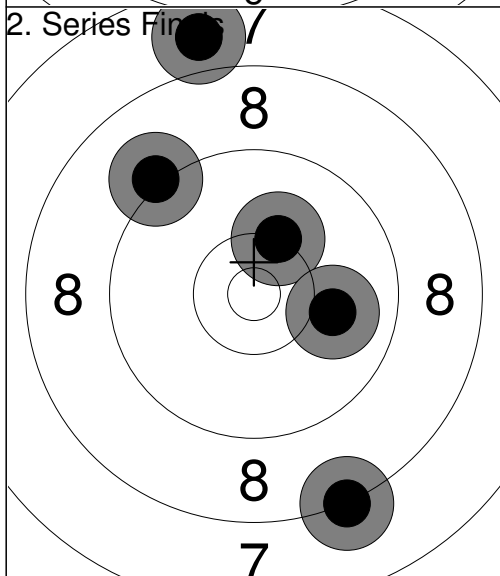

1:	7.8	↑
2:	8.2	↓
3:	9.1	↗
4:	10.2	↑
5:	10.0	→
Series	45.3	
	94.8	

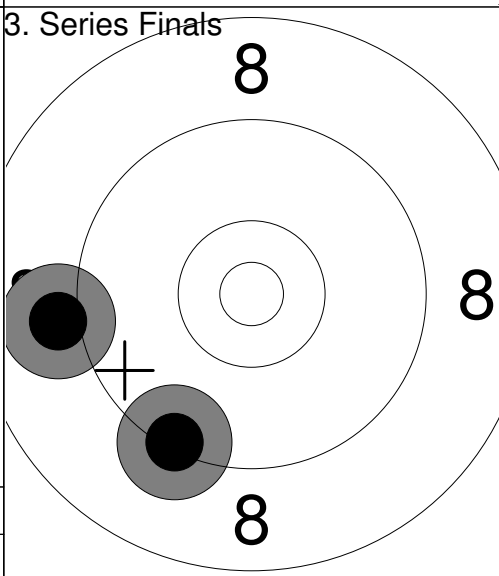

1:	9.3	↓
2:	9.0	←
Series	18.3	
	113.1	

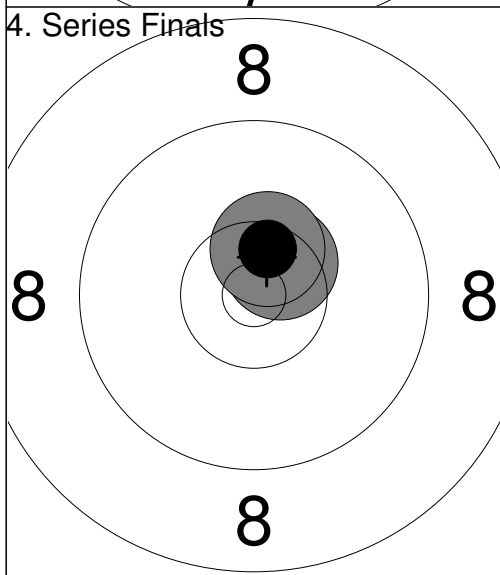

1:	10.5x	↗
2:	10.5x	↑
Series	21.0	
	134.1	

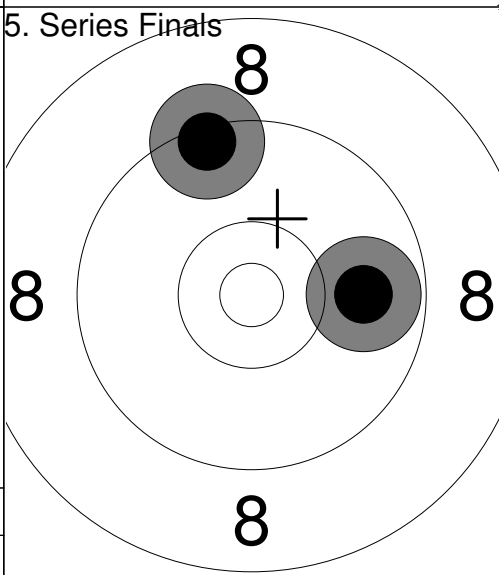

1:	9.4	↑
2:	9.9	→
Series	19.3	
	153.4	

6. Series Finals /

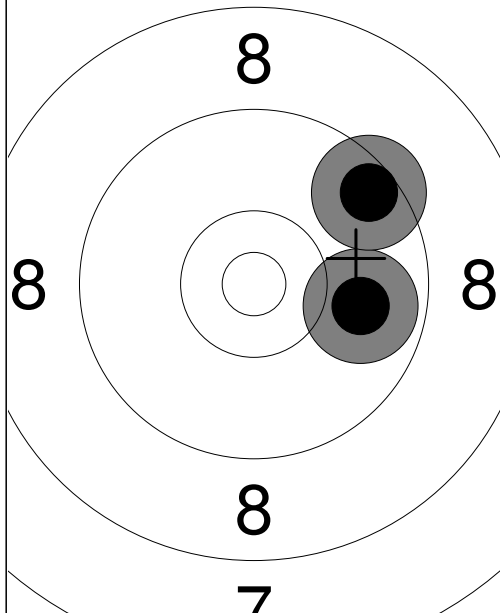

Series	19.4
	172.8

1: 9.9 →
2: 9.5 ↗

7. Series Finals 0

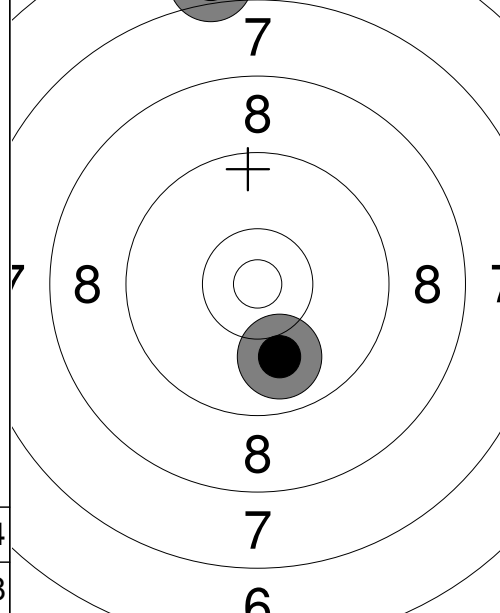

Series	16.9
	189.7

1: 6.9 ↑
2: 10.0 ↓

8. Series Finals 7

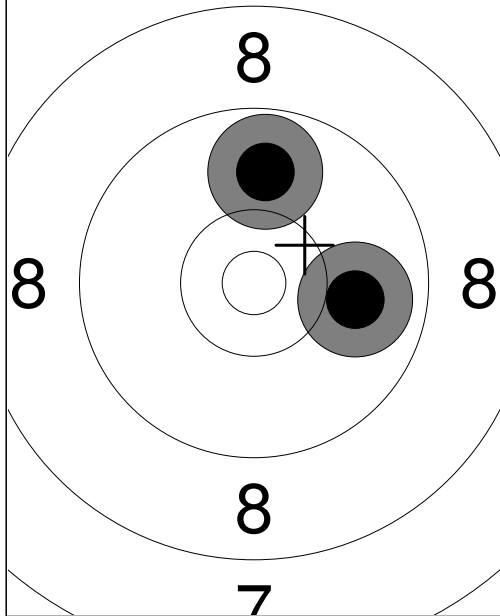

Series	19.8
	209.5

1: 9.9 →
2: 9.9 ↑

9. Series Finals 7

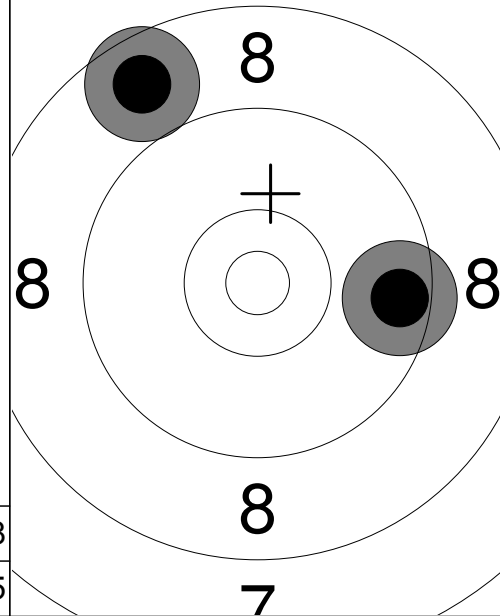

Series	18.2
	227.7

1: 8.7 ↖
2: 9.5 →

Relay 1	Lane 9	LI Xinyi
-------------------	------------------	-----------------

2023 Western Cdn Air Gun BC	F	WP
-----------------------------	---	----

14.10.2023	2023 WCAGC Finals AP60W	Alberta Handgun Association
------------	-------------------------	-----------------------------

Comment	Signature
---------	-----------

<p>Sight</p>	<p>Sight</p>	<p>11: 8.5 ↗</p>
<p>Series 91.0</p> <p>0.0</p>	<p>Series 8.5</p> <p>0.0</p>	

<p>1. Series Finals</p>	<p>2. Series Finals</p>	<p>1: 9.0 ↙</p> <p>2: 9.5 ↖</p> <p>3: 9.8 ↗</p> <p>4: 8.6 ←</p> <p>5: 10.7x ←</p>
<p>Series 45.6</p> <p>45.6</p>	<p>Series 47.6</p> <p>93.2</p>	

<p>3. Series Finals</p>	<p>4. Series Finals</p>	<p>1: 8.7 ↖</p> <p>2: 6.8 ←</p>
<p>Series 18.4</p> <p>111.6</p>	<p>Series 15.5</p> <p>127.1</p>	

5. Series Finals 7

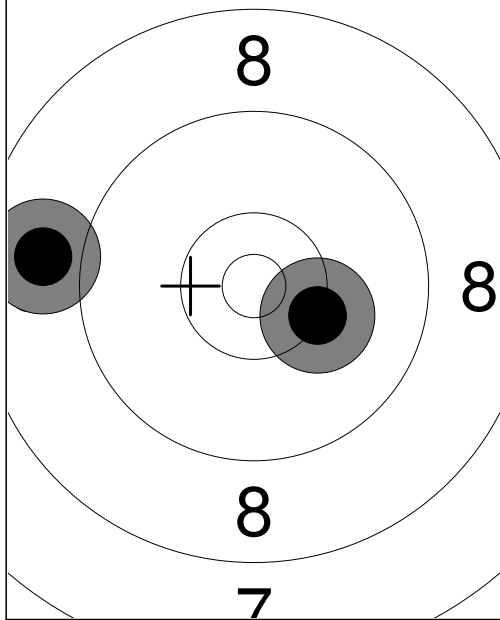

Series	19.2
	146.3

6. Series Finals 7

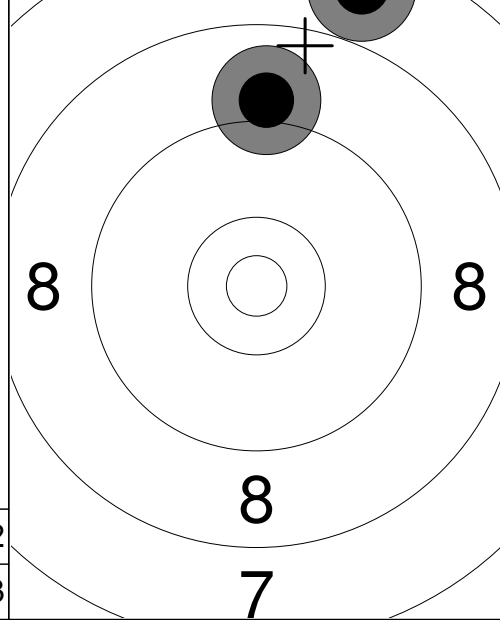

Series	16.6
	162.9

1: 8.9 ←
2: 10.3 →

1: 9.0 ↑
2: 7.6 ↗

7. Series Finals 7

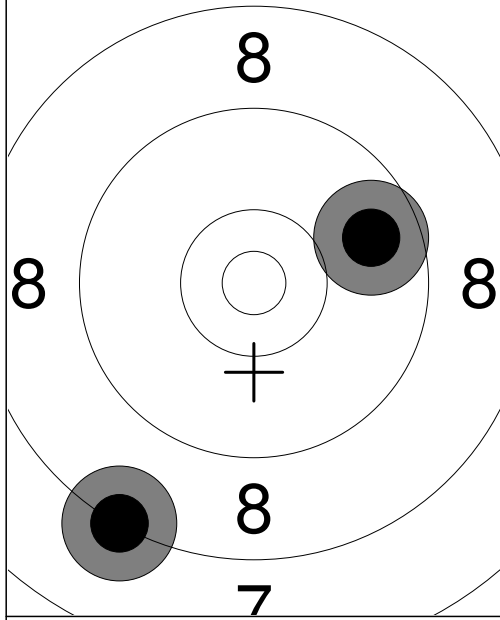

Series	17.9
	180.8

1: 9.7 →
2: 8.2 ↓

Relay 1	Lane 10	<h1>NELSON Makayla</h1>
-------------------	-------------------	-------------------------

2023 Western Cdn Air Gun SK	F	WP
-----------------------------	---	----

14.10.2023	2023 WCAGC Finals AP60W	Alberta Handgun Association
------------	-------------------------	-----------------------------

Comment	Signature
---------	-----------

<p>Sight 1</p>	<p>1: 8.2 ↙ 2: 8.3 ↓ 3: 9.8 ↗ 4: 7.4 ↗ 5: 9.4 ↗ 6: 9.9 → 7: 8.8 ↗</p>	<p>1. Series Finals 6</p>	<p>1: 7.7 ↖ 2: 6.7 ↖ 3: 9.4 ↗ 4: 10.1 → 5: 10.2 →</p>
Series 61.8		Series 44.1	
	0.0		44.1

<p>2. Series Finals</p>	<p>1: 10.3 ↑ 2: 6.9 ← 3: 8.8 ↗ 4: 7.2 ↗ 5: 8.6 ↓</p>	<p>3. Series Finals 6</p>	<p>1: 9.2 ↓ 2: 7.6 ←</p>
Series 41.8		Series 16.8	
	85.9		102.7

<p>4. Series Finals 7</p>	<p>1: 9.9 ↑ 2: 8.2 ←</p>	
Series 18.1		
	120.8	