

Relay **1** Lane **1** **LI Patrick**

2023 Western Cdn Air Gun AB JR MP

14.10.2023 2023 WCAGC Qualifier Alberta Handgun Association

Comment Signature

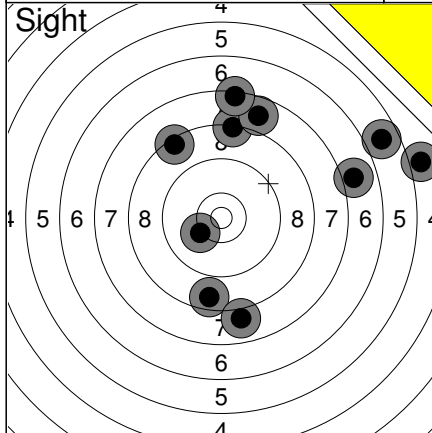

1:	4.9	→
2:	8.6	↓
3:	5.7	→
4:	8.3	↑
5:	8.0	↓
6:	7.8	↑
7:	8.4	↑
8:	7.4	↑
9:	10.2	↙
10:	6.9	→
Series	71 (0x)	
	0 (0x)	

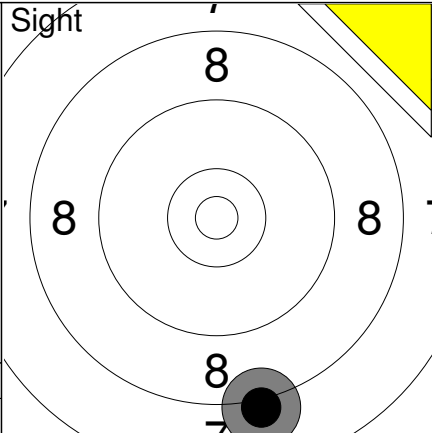

11:	8.1	↓
Series	8 (0x)	
	0 (0x)	

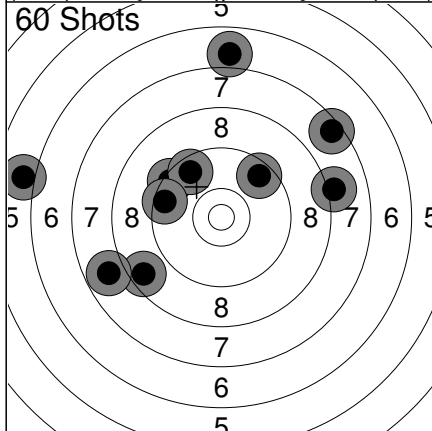

1:	9.4	↖
2:	7.5	↗
3:	9.6	↗
4:	5.9	↖
5:	8.6	↖
6:	6.9	↑
7:	7.8	↖
8:	9.6	↗
9:	8.1	→
10:	9.5	↖
Series	77 (0x)	
	77 (0x)	

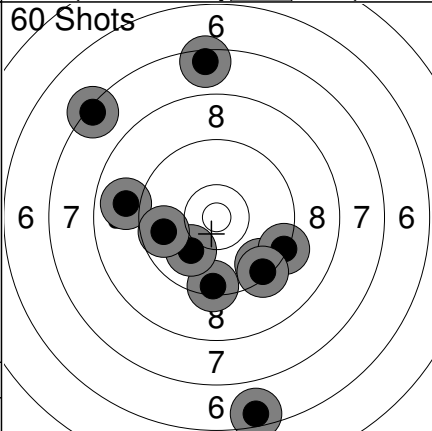

11:	8.9	↖
12:	9.5	↘
13:	9.4	↓
14:	7.5	↑
15:	9.3	↗
16:	10.0	↘
17:	7.4	↗
18:	9.7	↖
19:	9.4	↘
20:	6.5	↓
Series	83 (0x)	
	160 (0x)	

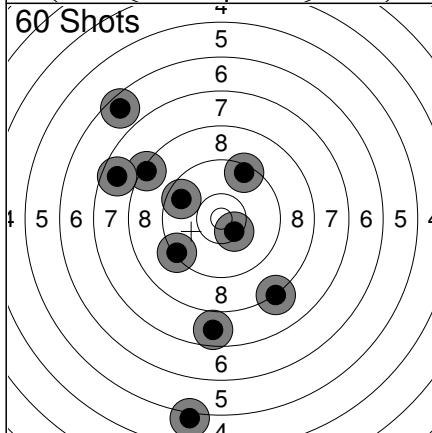

21:	6.6	↗
22:	8.2	↓
23:	8.4	↗
24:	9.5	↑
25:	7.7	↖
26:	10.4x	↓
27:	7.7	↓
28:	9.3	↖
29:	5.1	↓
30:	9.6	↖
Series	78 (1x)	
	238 (1x)	

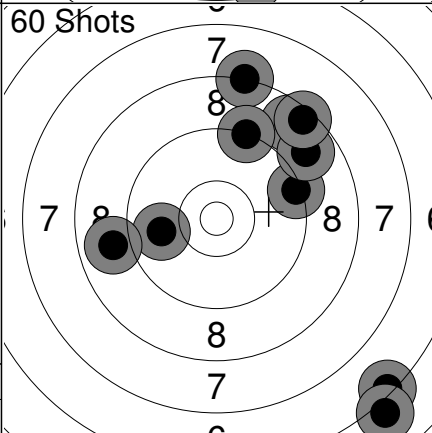

31:	6.3	↘
32:	8.2	↑
33:	9.9	↖
34:	8.7	↗
35:	9.3	→
36:	8.8	↗
37:	8.4	↗
38:	9.2	↑
39:	8.9	↖
40:	6.0	↘
Series	79 (0x)	
	317 (1x)	

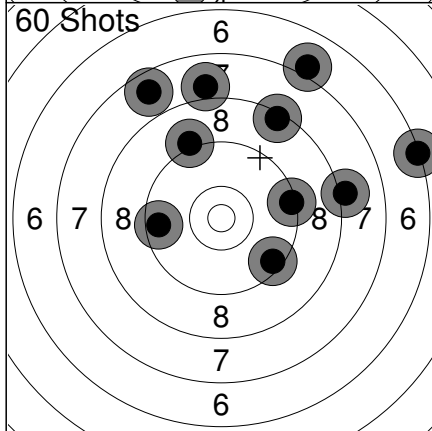

41:	9.3	→
42:	9.1	↑
43:	9.5	↖
44:	7.0	↑
45:	6.3	→
46:	8.0	↑
47:	7.7	↗
48:	9.4	↘
49:	8.1	→
50:	8.4	↑
Series	80 (0x)	
	397 (1x)	

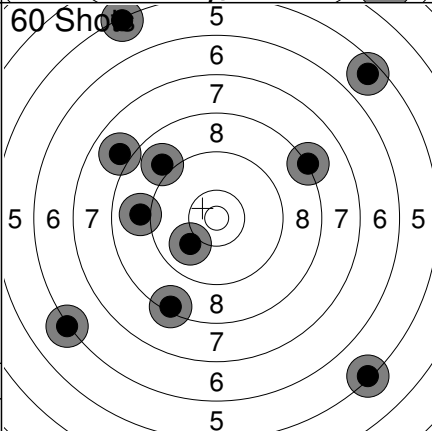

51:	6.2	↖
52:	9.0	↖
53:	5.6	↗
54:	5.3	↑
55:	9.0	↖
56:	8.4	↓
57:	5.3	↘
58:	7.9	↗
59:	8.2	↗
60:	10.0	↘
Series	72 (0x)	
	469 (1x)	

Relay <b>1</b>	Lane <b>2</b>	<b>KRUEGER Cameron</b>
-------------------	------------------	------------------------

2023 Western Cdn Air Gun SK	JR	MP
-----------------------------	----	----

14.10.2023	2023 WCAGC Qualifier	Alberta Handgun Association
------------	----------------------	-----------------------------

Comment	Signature
---------	-----------

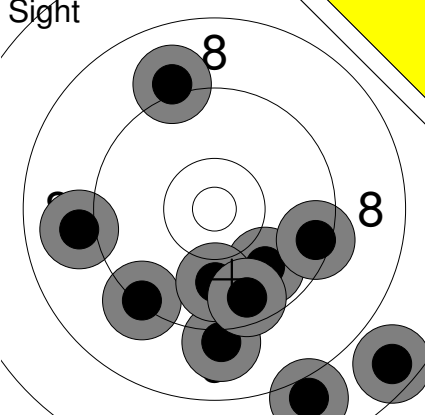
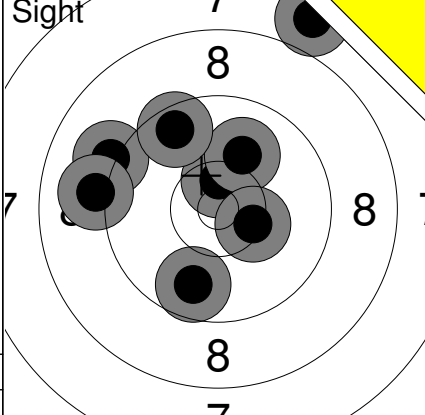
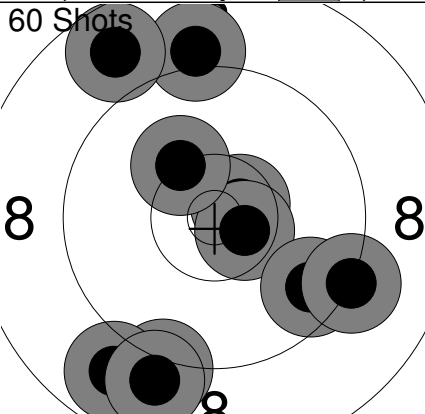
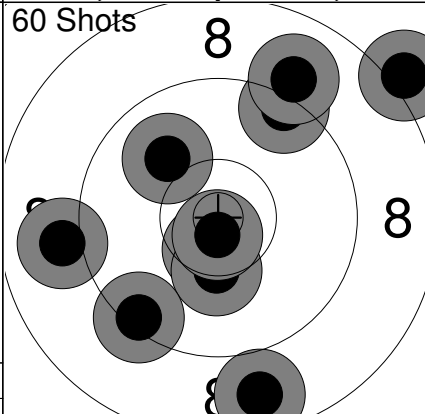
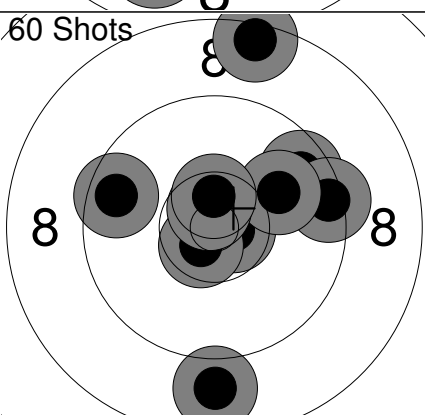
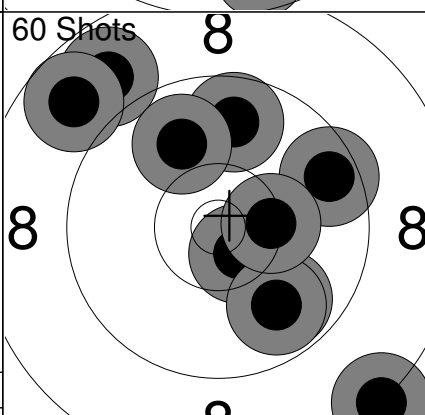
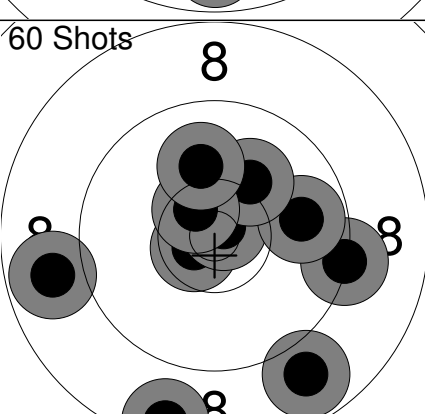
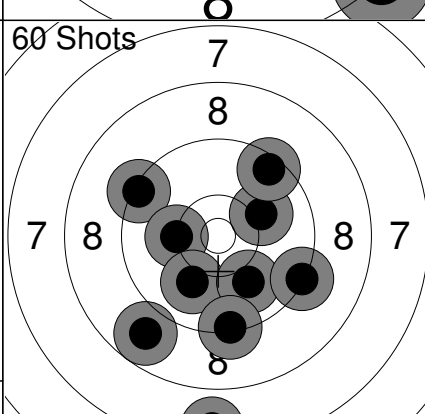
Sight 	<table border="1" style="width:100%; border-collapse: collapse;"> <tr><td>1:</td><td>9.9</td><td>↘</td></tr> <tr><td>2:</td><td>7.9</td><td>↘</td></tr> <tr><td>3:</td><td>9.1</td><td>↘</td></tr> <tr><td>4:</td><td>7.6</td><td>↘</td></tr> <tr><td>5:</td><td>9.3</td><td>↖</td></tr> <tr><td>6:</td><td>9.1</td><td>↗</td></tr> <tr><td>7:</td><td>9.4</td><td>→</td></tr> <tr><td>8:</td><td>9.9</td><td>↘</td></tr> <tr><td>9:</td><td>9.6</td><td>↘</td></tr> <tr><td>10:</td><td>9.0</td><td>←</td></tr> <tr><td>Series</td><td>86 (0x)</td><td></td></tr> <tr><td></td><td>0 (0x)</td><td></td></tr> </table>	1:	9.9	↘	2:	7.9	↘	3:	9.1	↘	4:	7.6	↘	5:	9.3	↖	6:	9.1	↗	7:	9.4	→	8:	9.9	↘	9:	9.6	↘	10:	9.0	←	Series	86 (0x)			0 (0x)		Sight 	<table border="1" style="width:100%; border-collapse: collapse;"> <tr><td>11:</td><td>9.1</td><td>↖</td></tr> <tr><td>12:</td><td>10.5x</td><td>↑</td></tr> <tr><td>13:</td><td>9.1</td><td>←</td></tr> <tr><td>14:</td><td>10.1</td><td>↑</td></tr> <tr><td>15:</td><td>9.6</td><td>↗</td></tr> <tr><td>16:</td><td>7.7</td><td>↗</td></tr> <tr><td>17:</td><td>9.7</td><td>↓</td></tr> <tr><td>18:</td><td>10.4x</td><td>→</td></tr> <tr><td>Series</td><td>73 (2x)</td><td></td></tr> <tr><td></td><td>0 (0x)</td><td></td></tr> </table>	11:	9.1	↖	12:	10.5x	↑	13:	9.1	←	14:	10.1	↑	15:	9.6	↗	16:	7.7	↗	17:	9.7	↓	18:	10.4x	→	Series	73 (2x)			0 (0x)							
1:	9.9	↘																																																																									
2:	7.9	↘																																																																									
3:	9.1	↘																																																																									
4:	7.6	↘																																																																									
5:	9.3	↖																																																																									
6:	9.1	↗																																																																									
7:	9.4	→																																																																									
8:	9.9	↘																																																																									
9:	9.6	↘																																																																									
10:	9.0	←																																																																									
Series	86 (0x)																																																																										
	0 (0x)																																																																										
11:	9.1	↖																																																																									
12:	10.5x	↑																																																																									
13:	9.1	←																																																																									
14:	10.1	↑																																																																									
15:	9.6	↗																																																																									
16:	7.7	↗																																																																									
17:	9.7	↓																																																																									
18:	10.4x	→																																																																									
Series	73 (2x)																																																																										
	0 (0x)																																																																										
60 Shots 	<table border="1" style="width:100%; border-collapse: collapse;"> <tr><td>1:</td><td>10.6x</td><td>→</td></tr> <tr><td>2:</td><td>9.1</td><td>↘</td></tr> <tr><td>3:</td><td>10.6x</td><td>→</td></tr> <tr><td>4:</td><td>8.9</td><td>↖</td></tr> <tr><td>5:</td><td>10.2</td><td>↗</td></tr> <tr><td>6:</td><td>9.6</td><td>↘</td></tr> <tr><td>7:</td><td>9.2</td><td>↘</td></tr> <tr><td>8:</td><td>9.0</td><td>↘</td></tr> <tr><td>9:</td><td>9.1</td><td>↑</td></tr> <tr><td>10:</td><td>8.8</td><td>↗</td></tr> <tr><td>Series</td><td>91 (2x)</td><td></td></tr> <tr><td></td><td>91 (2x)</td><td></td></tr> </table>	1:	10.6x	→	2:	9.1	↘	3:	10.6x	→	4:	8.9	↖	5:	10.2	↗	6:	9.6	↘	7:	9.2	↘	8:	9.0	↘	9:	9.1	↑	10:	8.8	↗	Series	91 (2x)			91 (2x)		60 Shots 	<table border="1" style="width:100%; border-collapse: collapse;"> <tr><td>11:</td><td>10.5x</td><td>↓</td></tr> <tr><td>12:</td><td>10.0</td><td>↖</td></tr> <tr><td>13:</td><td>9.4</td><td>↗</td></tr> <tr><td>14:</td><td>10.3</td><td>↓</td></tr> <tr><td>15:</td><td>9.0</td><td>↗</td></tr> <tr><td>16:</td><td>10.7x</td><td>↓</td></tr> <tr><td>17:</td><td>8.1</td><td>↗</td></tr> <tr><td>18:</td><td>8.7</td><td>↓</td></tr> <tr><td>19:</td><td>9.0</td><td>←</td></tr> <tr><td>20:</td><td>9.4</td><td>↘</td></tr> <tr><td>Series</td><td>92 (2x)</td><td></td></tr> <tr><td></td><td>183 (4x)</td><td></td></tr> </table>	11:	10.5x	↓	12:	10.0	↖	13:	9.4	↗	14:	10.3	↓	15:	9.0	↗	16:	10.7x	↓	17:	8.1	↗	18:	8.7	↓	19:	9.0	←	20:	9.4	↘	Series	92 (2x)			183 (4x)	
1:	10.6x	→																																																																									
2:	9.1	↘																																																																									
3:	10.6x	→																																																																									
4:	8.9	↖																																																																									
5:	10.2	↗																																																																									
6:	9.6	↘																																																																									
7:	9.2	↘																																																																									
8:	9.0	↘																																																																									
9:	9.1	↑																																																																									
10:	8.8	↗																																																																									
Series	91 (2x)																																																																										
	91 (2x)																																																																										
11:	10.5x	↓																																																																									
12:	10.0	↖																																																																									
13:	9.4	↗																																																																									
14:	10.3	↓																																																																									
15:	9.0	↗																																																																									
16:	10.7x	↓																																																																									
17:	8.1	↗																																																																									
18:	8.7	↓																																																																									
19:	9.0	←																																																																									
20:	9.4	↘																																																																									
Series	92 (2x)																																																																										
	183 (4x)																																																																										
60 Shots 	<table border="1" style="width:100%; border-collapse: collapse;"> <tr><td>21:</td><td>10.7x</td><td>→</td></tr> <tr><td>22:</td><td>10.7x</td><td>↘</td></tr> <tr><td>23:</td><td>8.8</td><td>↘</td></tr> <tr><td>24:</td><td>9.6</td><td>↗</td></tr> <tr><td>25:</td><td>9.4</td><td>→</td></tr> <tr><td>26:</td><td>10.0</td><td>↗</td></tr> <tr><td>27:</td><td>10.7x</td><td>↗</td></tr> <tr><td>28:</td><td>10.5x</td><td>↑</td></tr> <tr><td>29:</td><td>9.6</td><td>←</td></tr> <tr><td>30:</td><td>8.4</td><td>↑</td></tr> <tr><td>Series</td><td>93 (4x)</td><td></td></tr> <tr><td></td><td>276 (8x)</td><td></td></tr> </table>	21:	10.7x	→	22:	10.7x	↘	23:	8.8	↘	24:	9.6	↗	25:	9.4	→	26:	10.0	↗	27:	10.7x	↗	28:	10.5x	↑	29:	9.6	←	30:	8.4	↑	Series	93 (4x)			276 (8x)		60 Shots 	<table border="1" style="width:100%; border-collapse: collapse;"> <tr><td>31:</td><td>9.6</td><td>→</td></tr> <tr><td>32:</td><td>8.8</td><td>↗</td></tr> <tr><td>33:</td><td>8.2</td><td>↘</td></tr> <tr><td>34:</td><td>10.6x</td><td>↘</td></tr> <tr><td>35:</td><td>9.7</td><td>↑</td></tr> <tr><td>36:</td><td>9.9</td><td>↗</td></tr> <tr><td>37:</td><td>9.9</td><td>↘</td></tr> <tr><td>38:</td><td>9.8</td><td>↘</td></tr> <tr><td>39:</td><td>8.8</td><td>↗</td></tr> <tr><td>40:</td><td>10.3</td><td>→</td></tr> <tr><td>Series</td><td>89 (1x)</td><td></td></tr> <tr><td></td><td>365 (9x)</td><td></td></tr> </table>	31:	9.6	→	32:	8.8	↗	33:	8.2	↘	34:	10.6x	↘	35:	9.7	↑	36:	9.9	↗	37:	9.9	↘	38:	9.8	↘	39:	8.8	↗	40:	10.3	→	Series	89 (1x)			365 (9x)	
21:	10.7x	→																																																																									
22:	10.7x	↘																																																																									
23:	8.8	↘																																																																									
24:	9.6	↗																																																																									
25:	9.4	→																																																																									
26:	10.0	↗																																																																									
27:	10.7x	↗																																																																									
28:	10.5x	↑																																																																									
29:	9.6	←																																																																									
30:	8.4	↑																																																																									
Series	93 (4x)																																																																										
	276 (8x)																																																																										
31:	9.6	→																																																																									
32:	8.8	↗																																																																									
33:	8.2	↘																																																																									
34:	10.6x	↘																																																																									
35:	9.7	↑																																																																									
36:	9.9	↗																																																																									
37:	9.9	↘																																																																									
38:	9.8	↘																																																																									
39:	8.8	↗																																																																									
40:	10.3	→																																																																									
Series	89 (1x)																																																																										
	365 (9x)																																																																										
60 Shots 	<table border="1" style="width:100%; border-collapse: collapse;"> <tr><td>41:</td><td>10.7x</td><td>←</td></tr> <tr><td>42:</td><td>9.3</td><td>→</td></tr> <tr><td>43:</td><td>10.8x</td><td>↗</td></tr> <tr><td>44:</td><td>9.8</td><td>→</td></tr> <tr><td>45:</td><td>8.8</td><td>↘</td></tr> <tr><td>46:</td><td>10.1</td><td>↗</td></tr> <tr><td>47:</td><td>10.5x</td><td>↗</td></tr> <tr><td>48:</td><td>8.8</td><td>←</td></tr> <tr><td>49:</td><td>8.5</td><td>↘</td></tr> <tr><td>50:</td><td>10.0</td><td>↑</td></tr> <tr><td>Series</td><td>92 (3x)</td><td></td></tr> <tr><td></td><td>457 (12x)</td><td></td></tr> </table>	41:	10.7x	←	42:	9.3	→	43:	10.8x	↗	44:	9.8	→	45:	8.8	↘	46:	10.1	↗	47:	10.5x	↗	48:	8.8	←	49:	8.5	↘	50:	10.0	↑	Series	92 (3x)			457 (12x)		60 Shots 	<table border="1" style="width:100%; border-collapse: collapse;"> <tr><td>51:</td><td>10.1</td><td>↗</td></tr> <tr><td>52:</td><td>9.3</td><td>↖</td></tr> <tr><td>53:</td><td>10.2</td><td>←</td></tr> <tr><td>54:</td><td>8.8</td><td>↘</td></tr> <tr><td>55:</td><td>10.0</td><td>↘</td></tr> <tr><td>56:</td><td>10.0</td><td>↘</td></tr> <tr><td>57:</td><td>7.5</td><td>↓</td></tr> <tr><td>58:</td><td>9.3</td><td>→</td></tr> <tr><td>59:</td><td>9.5</td><td>↗</td></tr> <tr><td>60:</td><td>9.3</td><td>↓</td></tr> <tr><td>Series</td><td>91 (0x)</td><td></td></tr> <tr><td></td><td>548 (12x)</td><td></td></tr> </table>	51:	10.1	↗	52:	9.3	↖	53:	10.2	←	54:	8.8	↘	55:	10.0	↘	56:	10.0	↘	57:	7.5	↓	58:	9.3	→	59:	9.5	↗	60:	9.3	↓	Series	91 (0x)			548 (12x)	
41:	10.7x	←																																																																									
42:	9.3	→																																																																									
43:	10.8x	↗																																																																									
44:	9.8	→																																																																									
45:	8.8	↘																																																																									
46:	10.1	↗																																																																									
47:	10.5x	↗																																																																									
48:	8.8	←																																																																									
49:	8.5	↘																																																																									
50:	10.0	↑																																																																									
Series	92 (3x)																																																																										
	457 (12x)																																																																										
51:	10.1	↗																																																																									
52:	9.3	↖																																																																									
53:	10.2	←																																																																									
54:	8.8	↘																																																																									
55:	10.0	↘																																																																									
56:	10.0	↘																																																																									
57:	7.5	↓																																																																									
58:	9.3	→																																																																									
59:	9.5	↗																																																																									
60:	9.3	↓																																																																									
Series	91 (0x)																																																																										
	548 (12x)																																																																										

Relay **1** Lane **3** **LI Zekun**

2023 Western Cdn Air Gun BC JR MP

14.10.2023 2023 WCAGC Qualifier Alberta Handgun Association

Comment Signature

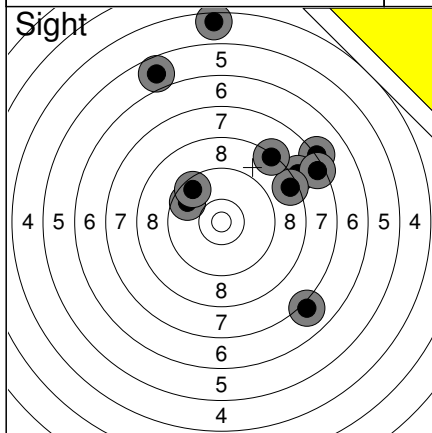

1:	7.2	↗
2:	8.0	↗
3:	7.5	↗
4:	7.1	↘
5:	8.5	↗
6:	8.3	↗
7:	5.8	↗
8:	9.7	↖
9:	9.6	↖
10:	4.5	↑
Series	72 (0x)	
	0 (0x)	

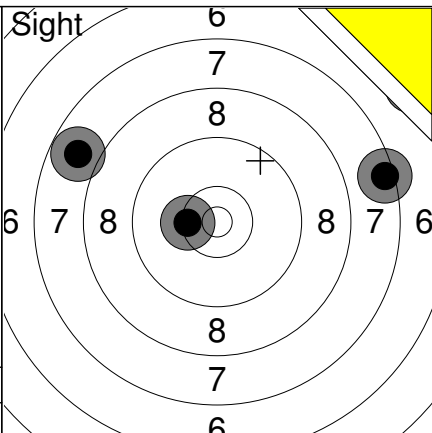

11:	10.4	←
12:	7.4	→
13:	7.8	↖
14:	6.1	↗
Series	30 (0x)	
	0 (0x)	

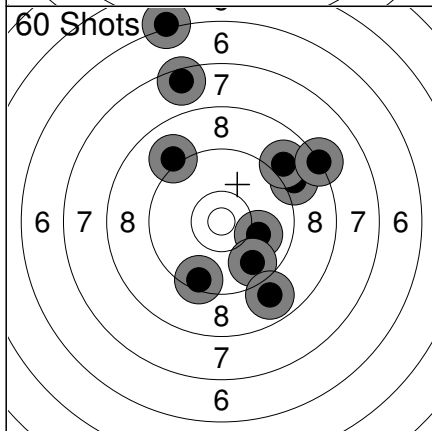

1:	10.0	→
2:	9.7	↘
3:	6.1	↗
4:	9.0	↗
5:	9.0	↗
6:	8.9	↘
7:	8.3	→
8:	9.5	↘
9:	7.5	↗
10:	9.1	↖
Series	84 (0x)	
	84 (0x)	

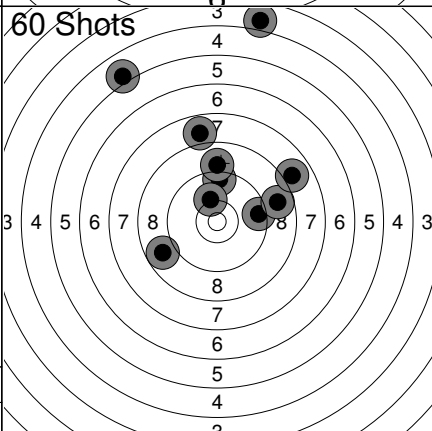

11:	9.5	↑
12:	5.0	↖
13:	9.5	→
14:	8.8	→
15:	9.0	↑
16:	7.9	↗
17:	7.8	↑
18:	3.9	↑
19:	10.2	↑
20:	8.8	↖
Series	75 (0x)	
	159 (0x)	

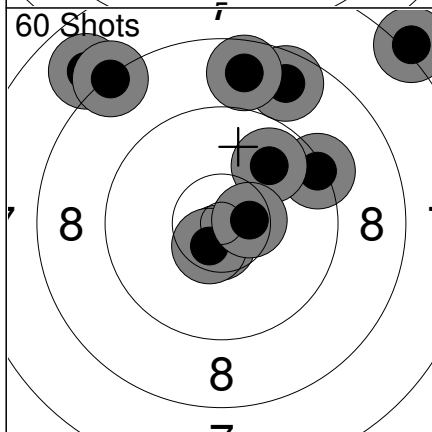

21:	10.7x	↓
22:	8.7	↑
23:	9.3	→
24:	10.6x	↘
25:	9.8	↗
26:	8.7	↑
27:	8.0	↗
28:	7.1	↗
29:	8.3	↗
30:	10.5x	→
Series	87 (3x)	
	246 (3x)	

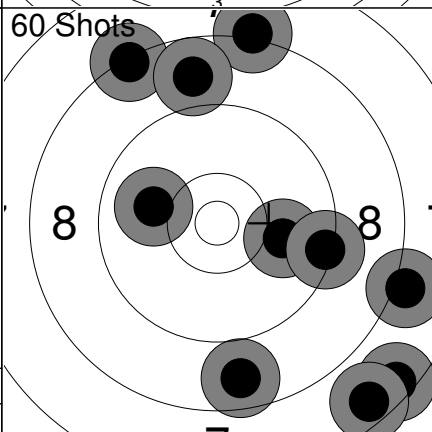

31:	10.0	→
32:	7.5	↘
33:	8.1	→
34:	9.3	→
35:	8.3	↗
36:	7.6	↘
37:	10.0	←
38:	8.7	↓
39:	8.2	↑
40:	8.8	↑
Series	83 (0x)	
	329 (3x)	

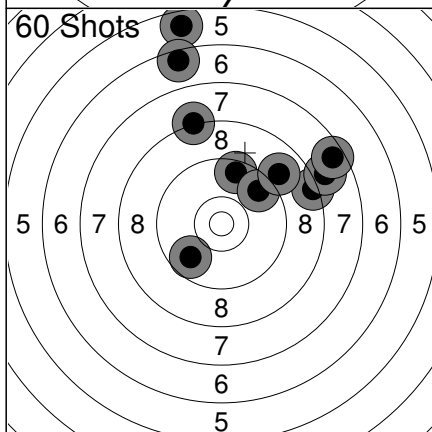

41:	8.4	→
42:	8.2	↑
43:	9.5	↑
44:	5.6	↑
45:	9.7	↖
46:	9.6	↗
47:	7.9	→
48:	8.9	↗
49:	6.5	↑
50:	7.5	↗
Series	76 (0x)	
	405 (3x)	

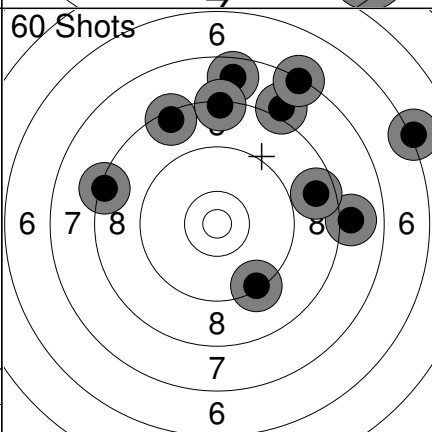

51:	8.3	←
52:	7.7	↑
53:	8.0	→
54:	8.0	↗
55:	9.3	↘
56:	7.3	↗
57:	8.4	↖
58:	8.3	↑
59:	6.2	→
60:	8.6	→
Series	77 (0x)	
	482 (3x)	

Comment	Signature
---------	-----------

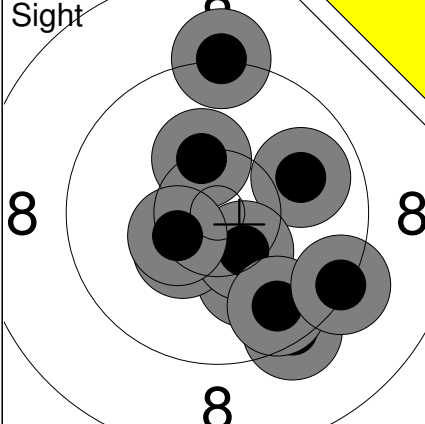
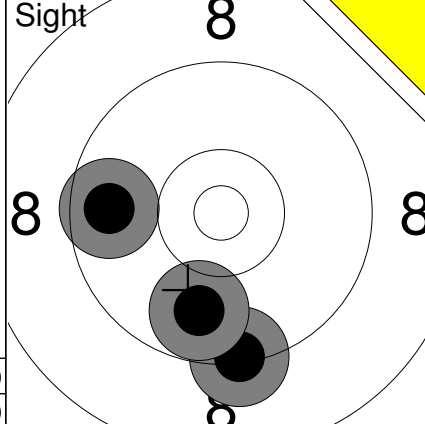
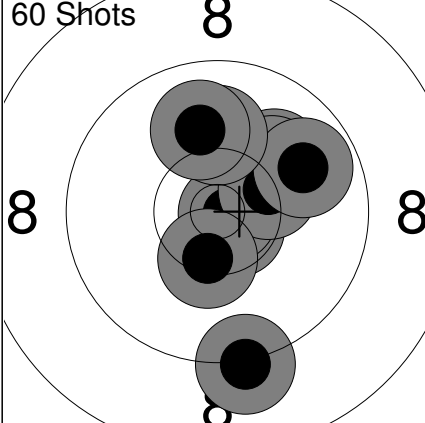
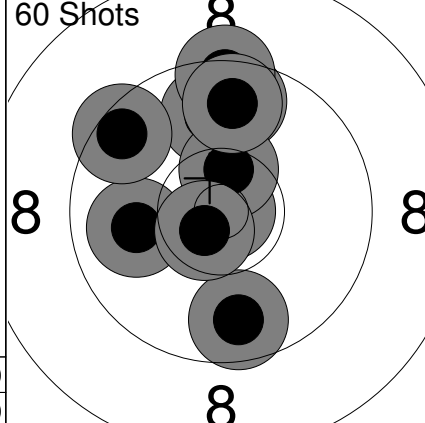
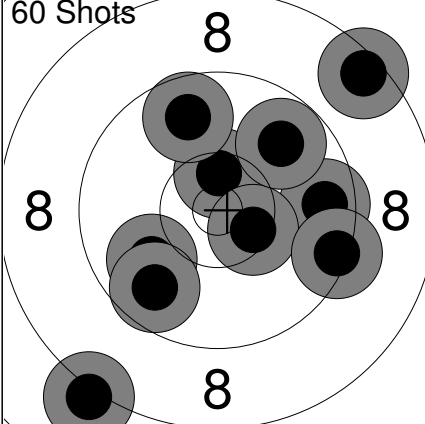
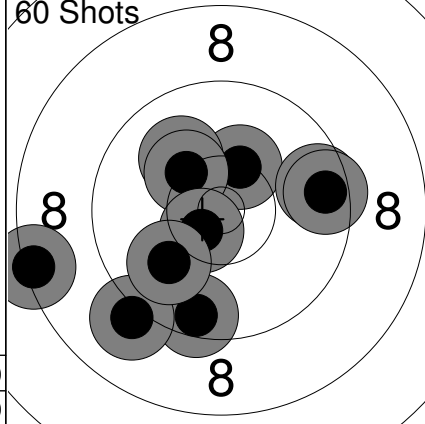
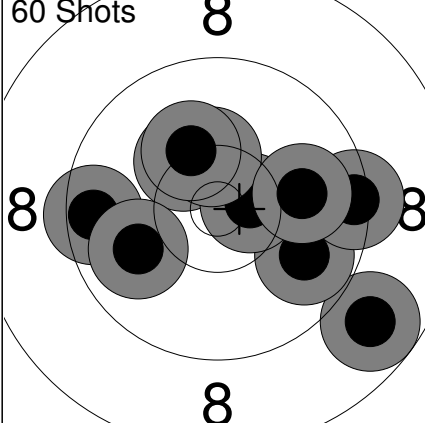
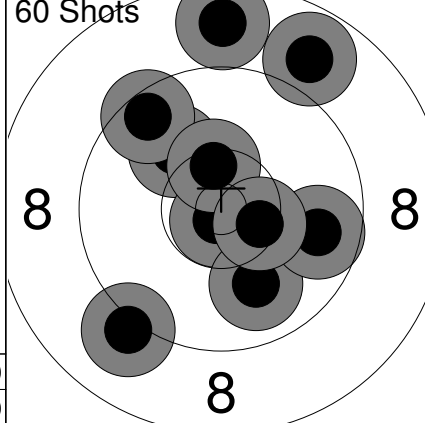
<p>Sight</p> 	<p>1: 10.1 ↓ 2: 9.4 ↓↓ 3: 9.9 → 4: 10.4x ← 5: 10.4x ↓ 6: 9.7 ↓↓ 7: 9.2 ↑ 8: 10.3 ↑ 9: 10.4x ← 10: 9.3 ↓</p> <p>Series 95 (3x) 0 (0x)</p>	<p>Sight</p> 	<p>11: 9.3 ↓ 12: 9.7 ← 13: 9.8 ↓</p> <p>Series 27 (0x) 0 (0x)</p>
<p>60 Shots</p> 	<p>1: 10.1 ↗ 2: 10.1 ↗ 3: 10.7x ↓ 4: 10.8x → 5: 10.3 → 6: 9.9 → 7: 9.2 ↓ 8: 10.1 ↑ 9: 10.4x ↓ 10: 10.0 ↑</p> <p>Series 98 (3x) 98 (3x)</p>	<p>60 Shots</p> 	<p>11: 10.0 ← 12: 9.7 ↑ 13: 9.9 ↑ 14: 10.9x → 15: 10.5x ↑ 16: 9.5 ↖ 17: 9.4 ↑ 18: 9.7 ↑ 19: 9.7 ↓ 20: 10.7x ↙</p> <p>Series 94 (3x) 192 (6x)</p>
<p>60 Shots</p> 	<p>21: 10.5x ↑ 22: 9.9 ← 23: 8.5 ↗ 24: 9.6 → 25: 10.4x ↓ 26: 9.4 → 27: 8.1 ↓ 28: 9.8 ↗ 29: 9.7 ↑ 30: 9.7 ↙</p> <p>Series 90 (2x) 282 (8x)</p>	<p>60 Shots</p> 	<p>31: 9.5 ↓ 32: 8.3 ← 33: 10.3 ↑ 34: 9.6 → 35: 10.1 ↗ 36: 10.3 ↖ 37: 9.1 ↓ 38: 10.6x ↙ 39: 9.5 → 40: 10.0 ↙</p> <p>Series 94 (1x) 376 (9x)</p>
<p>60 Shots</p> 	<p>41: 8.8 ↓ 42: 9.8 ↓ 43: 10.3 ↗ 44: 9.4 → 45: 10.6x → 46: 9.5 ← 47: 10.3 ↑ 48: 10.2 ↗ 49: 9.9 ← 50: 10.0 →</p> <p>Series 94 (1x) 470 (10x)</p>	<p>60 Shots</p> 	<p>51: 10.1 ↖ 52: 10.8x ↓ 53: 9.5 ↖ 54: 8.7 ↑ 55: 10.0 ↓ 56: 9.7 → 57: 8.8 ↗ 58: 10.4x ↑ 59: 10.4x → 60: 9.1 ↙</p> <p>Series 93 (3x) 563 (13x)</p>

Relay **1** Lane **5** **OLSEN Jesse**

2023 Western Cdn Air Gun SK SR MP

14.10.2023 2023 WCAGC Qualifier Alberta Handgun Association

Comment Signature

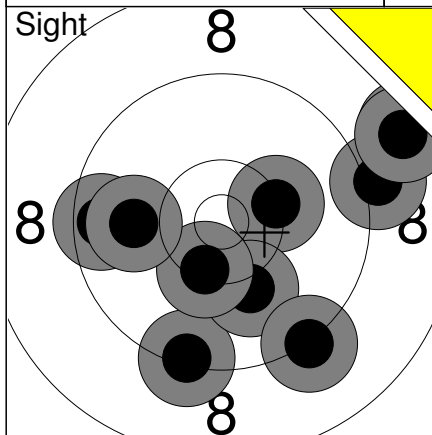

1:	10.3	→
2:	9.3	↓
3:	10.1	↓
4:	10.4x	↓
5:	8.5	→
6:	9.1	→
7:	8.6	→
8:	9.6	←
9:	9.9	←
10:	9.2	↓
Series	91 (1x)	
	0 (0x)	

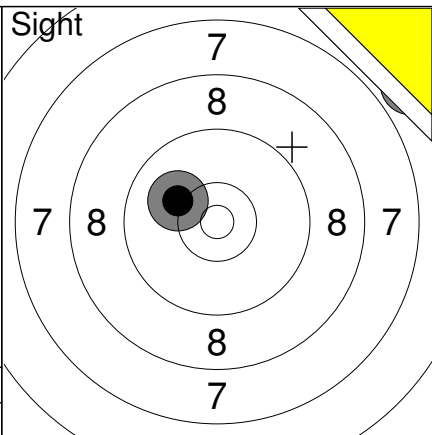

11:	10.1	↖
12:	6.6	↗
Series	16 (0x)	
	0 (0x)	

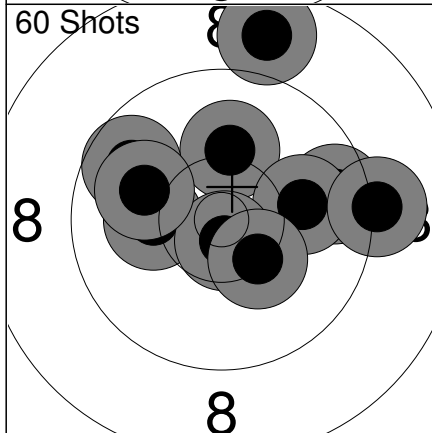

1:	9.6	→
2:	10.1	↑
3:	9.8	↖
4:	10.0	→
5:	10.2	←
6:	10.7x	↓
7:	8.8	↑
8:	9.2	→
9:	10.3	↓
10:	10.0	↖
Series	95 (1x)	
	95 (1x)	

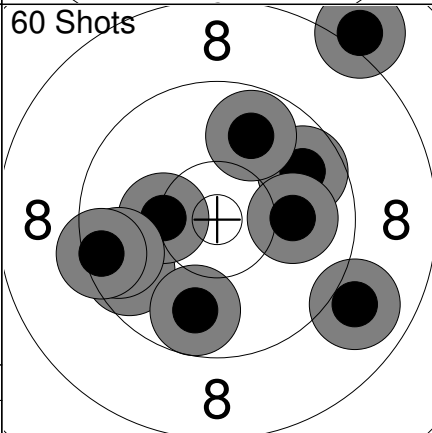

11:	9.7	↖
12:	9.7	↗
13:	8.0	↗
14:	8.9	↘
15:	10.3	←
16:	9.8	↓
17:	10.0	→
18:	9.8	↑
19:	9.7	←
20:	9.5	←
Series	90 (0x)	
	185 (1x)	

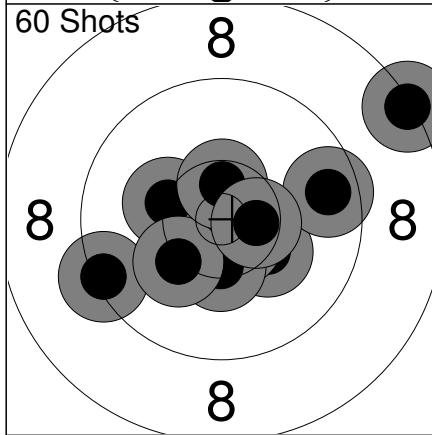

21:	9.3	←
22:	8.3	↗
23:	10.3	↘
24:	9.6	→
25:	10.6x	↓
26:	10.4x	↓
27:	10.3	↖
28:	10.2	↖
29:	10.5x	↑
30:	10.5x	→
Series	96 (4x)	
	281 (5x)	

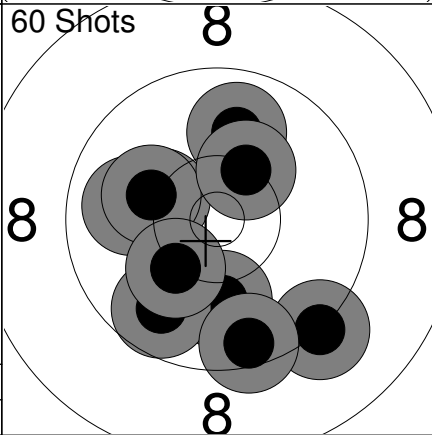

31:	9.9	↑
32:	10.0	↓
33:	10.3	↖
34:	9.2	↘
35:	9.8	↓
36:	9.5	↓
37:	10.0	←
38:	10.2	←
39:	10.3	↗
40:	10.2	↘
Series	96 (0x)	
	377 (5x)	

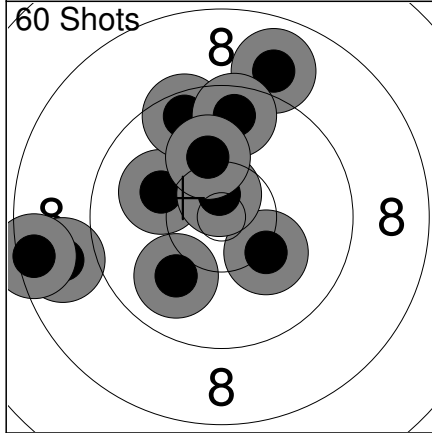

41:	8.8	←
42:	10.1	↖
43:	8.9	↑
44:	9.5	↑
45:	10.0	↓
46:	9.6	↑
47:	10.2	↘
48:	10.7x	↑
49:	10.2	↑
50:	8.4	←
Series	92 (1x)	
	469 (6x)	

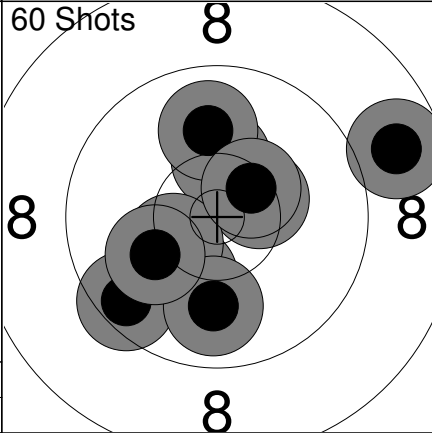

51:	10.3	↑
52:	10.4x	↗
53:	10.2	↓
54:	10.0	↑
55:	9.5	↖
56:	8.8	↗
57:	10.4x	↖
58:	9.9	↓
59:	10.1	↖
60:	10.4x	↗
Series	96 (3x)	
	565 (9x)	

Relay <b>1</b>	Lane <b>6</b>	<h1>HAGLUND Wayne</h1>
-------------------	------------------	------------------------

2023 Western Cdn Air Gun AB	SP	MP
-----------------------------	----	----

14.10.2023	2023 WCAGC Qualifier	Alberta Handgun Association
------------	----------------------	-----------------------------

Comment	Signature
---------	-----------

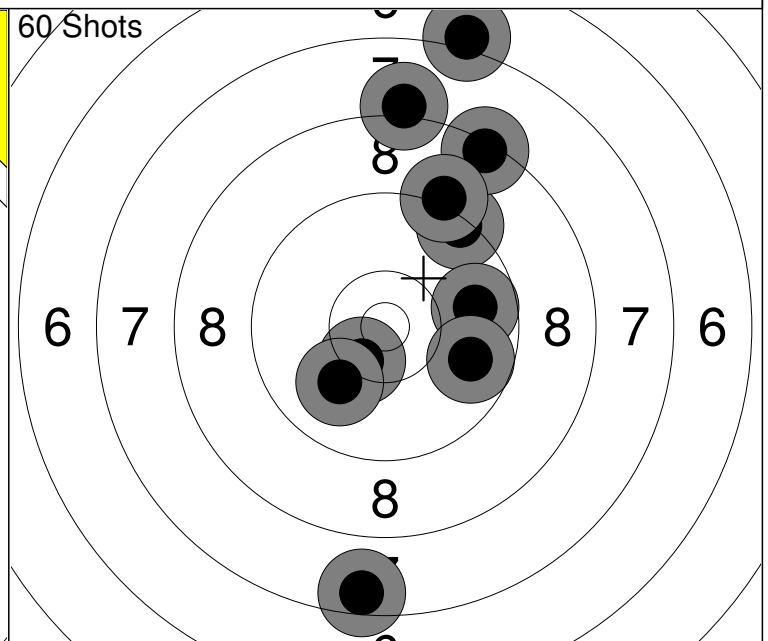
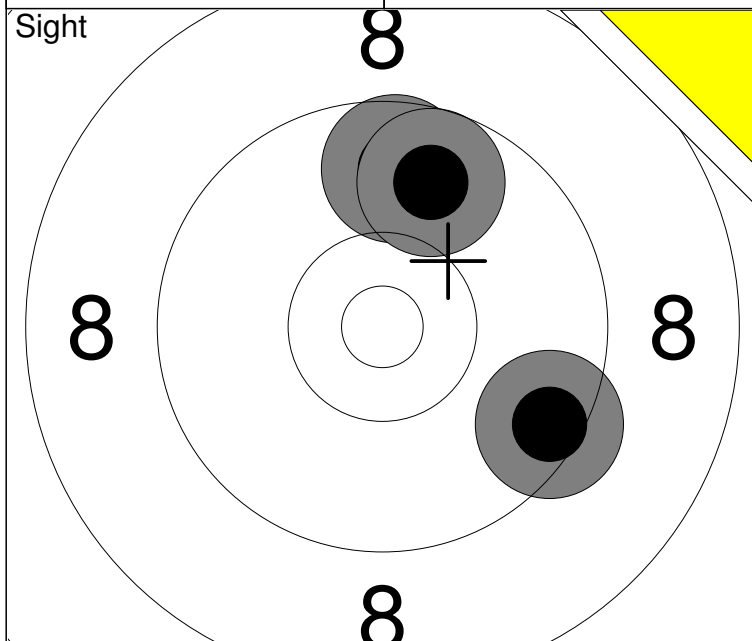

1: 9.5 ↘	Series	27 (0x)
2: 9.7 ↑		
3: 9.8 ↑		
		0 (0x)

1: 7.5 ↓	6: 8.3 ↗	Series	86 (1x)
2: 10.4x ↘	7: 7.1 ↑		
3: 10.0 ↘	8: 9.1 ↑		
4: 8.1 ↑	9: 9.8 →		
5: 9.3 ↗	10: 9.8 →	86 (1x)	

11: 8.6 ↑	16: 10.0 →	Series	91 (0x)
12: 8.9 ↗	17: 9.8 →		
13: 9.8 ↗	18: 9.9 ↓		
14: 10.0 →	19: 9.3 ↘		
15: 9.7 ↗	20: 10.1 ↘	177 (1x)	

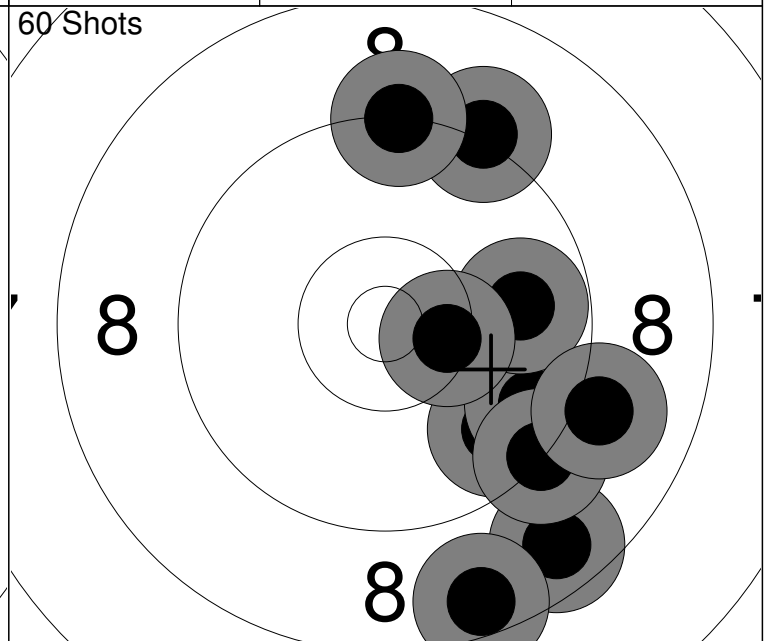
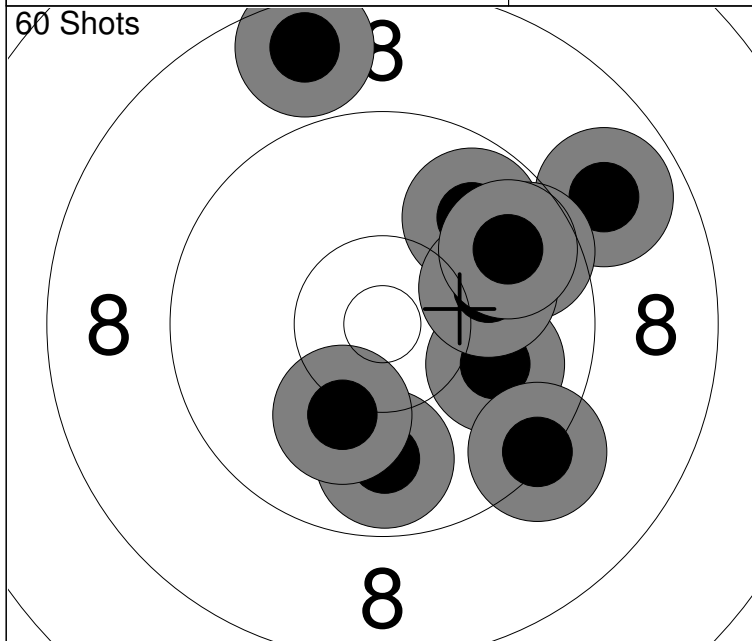

21: 8.6 ↓	26: 9.3 ↘	Series	89 (1x)
22: 9.7 ↘	27: 9.2 ↑		
23: 9.6 ↘	28: 9.8 →		
24: 9.2 ↗	29: 10.4x →		
25: 8.5 ↓	30: 9.0 →	266 (2x)	

21: 8.6 ↓	26: 9.3 ↘	Series	89 (1x)
22: 9.7 ↘	27: 9.2 ↑		
23: 9.6 ↘	28: 9.8 →		
24: 9.2 ↗	29: 10.4x →		
25: 8.5 ↓	30: 9.0 →	266 (2x)	

Relay **1** Lane **7** **HAN Kally**

2023 Western Cdn Air Gun BC JR WP

14.10.2023 2023 WCAGC Qualifier Alberta Handgun Association

Comment Signature

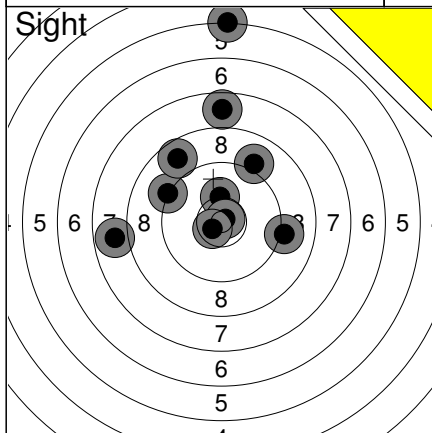

1:	10.2	↑
2:	9.2	↖
3:	10.8x	↗
4:	7.8	←
5:	9.1	→
6:	5.2	↑
7:	7.7	↑
8:	8.7	↗
9:	9.0	↗
10:	10.6x	↙
Series	84 (2x)	
	0 (0x)	

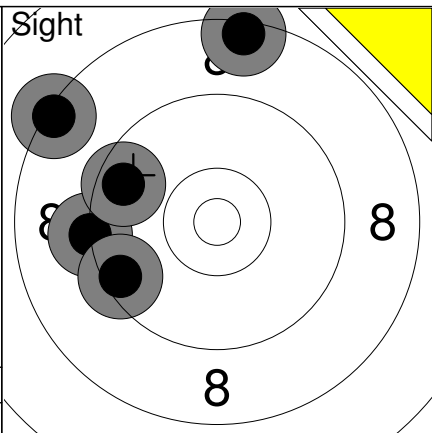

11:	9.2	←
12:	8.3	↖
13:	9.5	↙
14:	8.4	↑
15:	9.6	↖
Series	43 (0x)	
	0 (0x)	

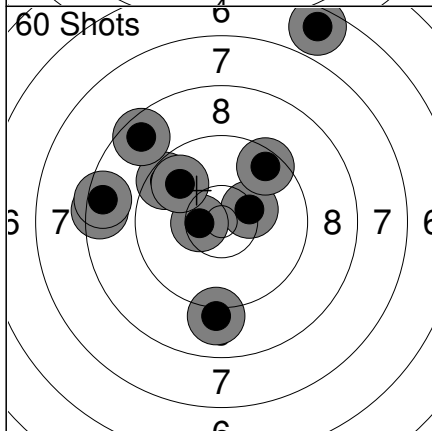

1:	10.3	→
2:	8.5	←
3:	9.5	↗
4:	9.6	↖
5:	10.5x	←
6:	9.1	↘
7:	8.5	←
8:	8.6	↗
9:	6.6	↗
10:	9.8	↗
Series	86 (1x)	
	86 (1x)	

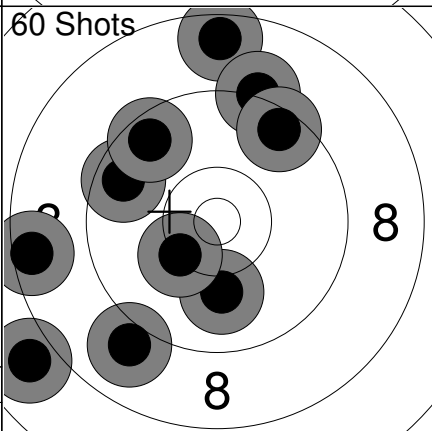

11:	10.0	↓
12:	8.5	↑
13:	7.9	↙
14:	8.5	←
15:	9.0	↘
16:	9.2	↑
17:	9.5	↗
18:	9.6	←
19:	10.3	↙
20:	9.6	↖
Series	88 (0x)	
	174 (1x)	

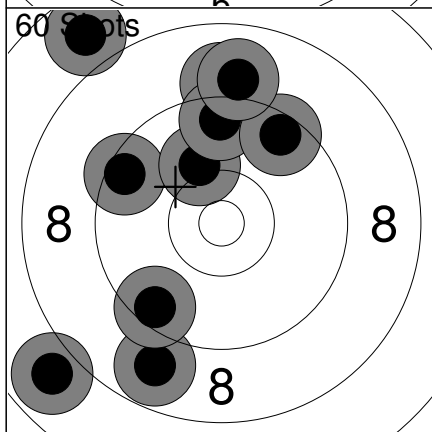

21:	9.0	↑
22:	9.5	↖
23:	10.1	↗
24:	9.5	↑
25:	9.5	↗
26:	7.8	↗
27:	8.8	↘
28:	9.5	↙
29:	7.9	↙
30:	9.0	↑
Series	86 (0x)	
	260 (1x)	

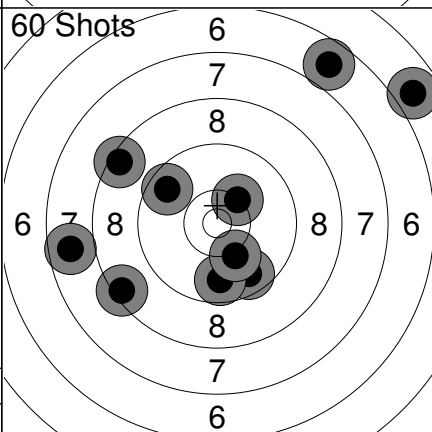

31:	9.6	↖
32:	10.3	↗
33:	9.6	↘
34:	8.5	↖
35:	9.7	↓
36:	10.1	↓
37:	8.4	↙
38:	6.7	↗
39:	5.8	↗
40:	7.7	←
Series	81 (0x)	
	341 (1x)	

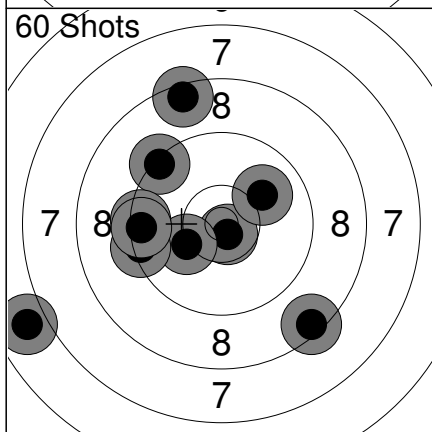

41:	8.4	↘
42:	10.7x	↘
43:	10.2	←
44:	8.5	↗
45:	9.3	↗
46:	9.4	←
47:	9.4	←
48:	10.0	↗
49:	6.9	←
50:	9.4	←
Series	88 (1x)	
	429 (2x)	

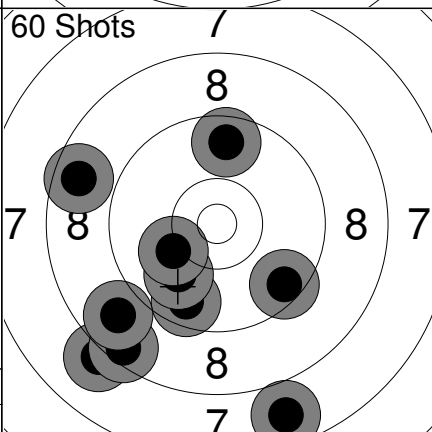

51:	9.6	↑
52:	8.1	↙
53:	8.5	↘
54:	9.5	↘
55:	8.6	←
56:	9.6	↘
57:	9.9	↙
58:	7.7	↓
59:	8.8	↙
60:	10.1	↙
Series	85 (0x)	
	514 (2x)	

Relay **1** Lane **8** **NELSON Makayla**

2023 Western Cdn Air Gun SK JR WP

14.10.2023 2023 WCAGC Qualifier Alberta Handgun Association

Comment Signature

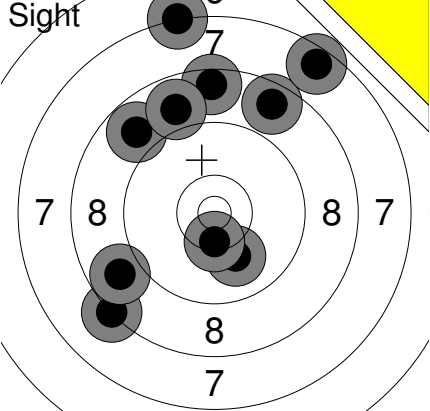
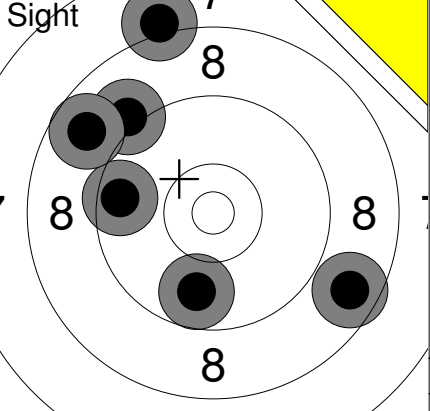
	1: 7.2 ↑		11: 8.1 ↑
	2: 8.3 ↙		12: 9.1 ↗
	3: 8.8 ←		13: 8.6 ↘
	4: 8.8 ↗		14: 9.6 ←
	5: 10.0 ↘		15: 8.7 ↗
	6: 8.6 ↗		16: 9.8 ↓
	7: 7.5 ↗		
	8: 10.4x ↓		
	9: 8.5 ↑		
	10: 8.9 ↑		
	Series 82 (1x)		Series 51 (0x)
	0 (0x)		0 (0x)

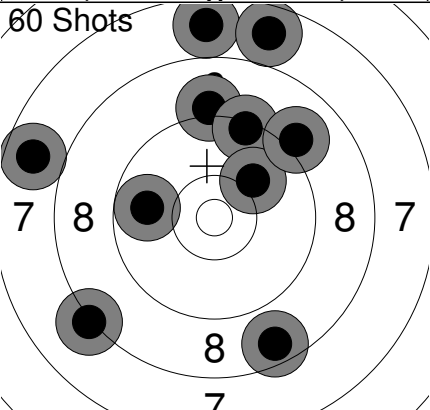
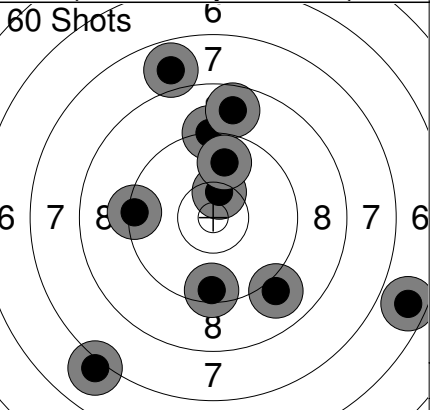
	1: 9.8 ←		11: 7.8 ↑
	2: 7.7 ←		12: 10.4x ↑
	3: 7.7 ↑		13: 6.6 →
	4: 8.2 ←		14: 9.2 ↑
	5: 9.1 ↑		15: 9.0 ↘
	6: 9.3 ↑		16: 9.5 ↓
	7: 10.0 ↗		17: 7.1 ↙
	8: 7.7 ↑		18: 8.7 ↑
	9: 9.0 ↗		19: 9.3 ←
	10: 8.6 ↓		20: 9.8 ↑
	Series 83 (0x)		Series 83 (1x)
	83 (0x)		166 (1x)

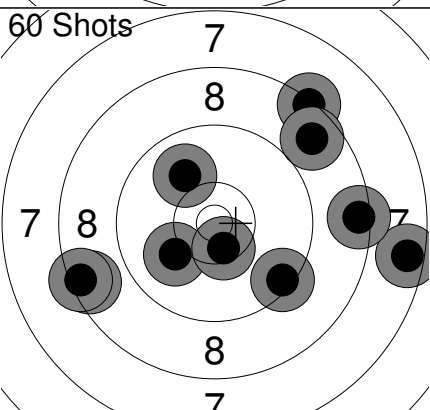
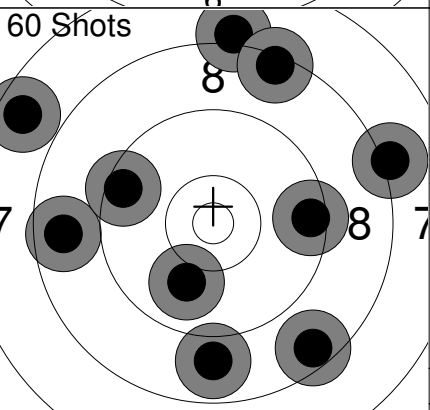
	21: 8.3 ↗		31: 10.0 ↓
	22: 10.1 ←		32: 8.1 ↑
	23: 9.4 ↘		33: 8.5 ↘
	24: 8.5 ←		34: 8.4 ↑
	25: 10.5x ↓		35: 7.6 ↖
	26: 8.4 ←		36: 8.7 ←
	27: 8.7 ↗		37: 9.5 →
	28: 10.0 ↗		38: 8.1 →
	29: 7.5 →		39: 8.9 ↓
	30: 8.4 →		40: 9.5 ←
	Series 86 (1x)		Series 83 (0x)
	252 (2x)		335 (2x)

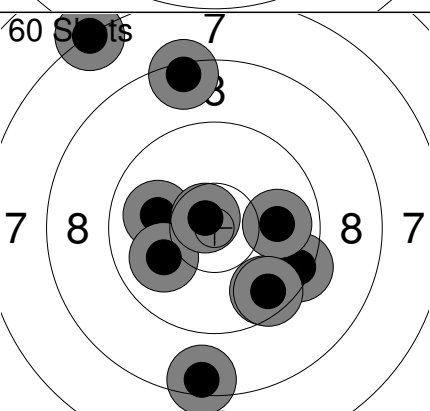
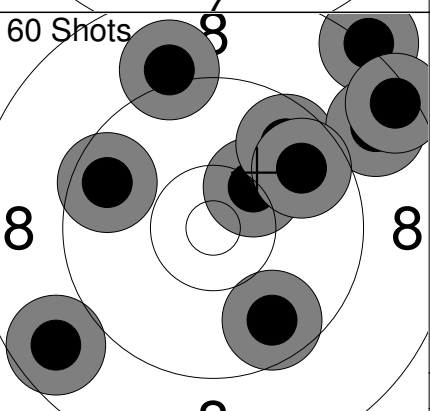
	41: 9.7 ↘		51: 9.7 ↓
	42: 10.0 ←		52: 10.3 ↗
	43: 9.5 ↘		53: 8.2 ↗
	44: 10.0 ←		54: 8.7 ↖
	45: 9.9 →		55: 9.1 ↑
	46: 8.4 ↑		56: 9.7 ↗
	47: 8.5 ↘		57: 8.8 ↗
	48: 7.3 ↗		58: 9.7 ↗
	49: 10.7x ↗		59: 9.6 ←
	50: 9.6 ↓		60: 8.4 ↗
	Series 89 (1x)		Series 87 (0x)
	424 (3x)		511 (3x)



	<p>1: 8.4 → 2: 8.6 ↓ 3: 9.7 ← 4: 10.2 ↗ 5: 9.7 ↙ 6: 9.4 ← 7: 10.7x ↓ 8: 8.8 ↓ 9: 9.0 ↘ 10: 5.6 ↑</p> <p>Series 85 ( 1x) 0 ( 0x)</p>		<p>11: 10.0 ↗ 12: 9.8 ↓ 13: 9.7 ↓ 14: 10.0 ↖ 15: 10.4x ↗ 16: 10.2 ↖ 17: 6.8 ↑ 18: 8.2 ↗ 19: 8.4 ↑ 20: 8.6 ↑</p> <p>Series 88 ( 1x) 0 ( 0x)</p>
--	---	--	--

	<p>21: 10.0 ↘ 22: 10.0 ←</p> <p>Series 20 ( 0x) 0 ( 0x)</p>		<p>1: 9.8 ↓ 2: 7.6 ↑ 3: 8.6 ↓ 4: 9.4 ← 5: 7.0 ↘ 6: 9.7 ↖ 7: 8.6 ↗ 8: 8.0 ↑ 9: 9.0 ↗ 10: 10.2 ↓</p> <p>Series 84 ( 0x) 84 ( 0x)</p>
--	---	--	--

	<p>11: 6.9 ← 12: 7.5 ↗ 13: 9.1 ↓ 14: 9.5 → 15: 6.9 ↗ 16: 8.7 ↙ 17: 9.0 ↑ 18: 10.4x ← 19: 10.0 → 20: 10.2 ↖</p> <p>Series 84 ( 1x) 168 ( 1x)</p>		<p>21: 9.2 → 22: 9.0 ← 23: 10.0 → 24: 8.3 ↓ 25: 9.3 ↓ 26: 10.7x ↑ 27: 10.5x ← 28: 10.4x ← 29: 9.7 ↓ 30: 9.8 ↙</p> <p>Series 93 ( 3x) 261 ( 4x)</p>
--	---	--	--

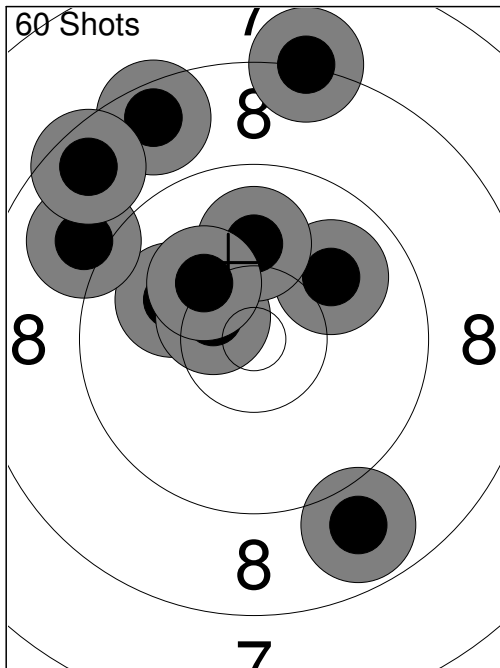

31:	8.2	↑
32:	10.0	↗
33:	8.6	↑
34:	10.1	←
35:	10.5x	↖
36:	9.0	↖
37:	8.9	↓
38:	10.0	↑
39:	8.6	↘
40:	10.2	↖
Series	91 ( 1x)	
	352 ( 5x)	

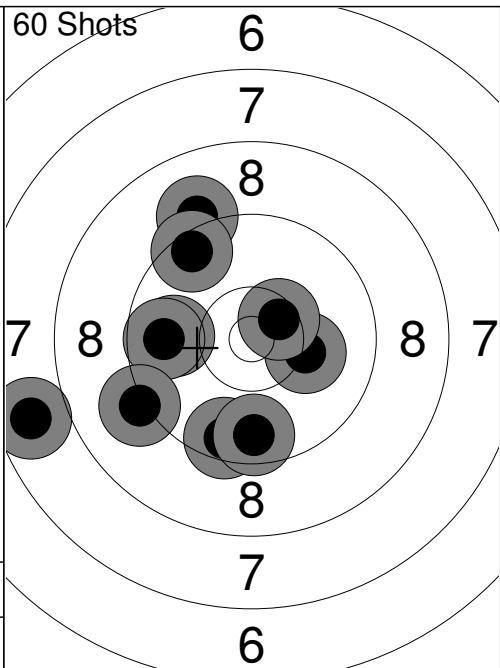

41:	7.7	←
42:	9.5	↓
43:	10.2	⇒
44:	9.9	←
45:	9.6	↓
46:	9.1	↑
47:	9.7	←
48:	9.2	↙
49:	10.5x	↗
50:	9.5	↖
Series	90 ( 1x)	
	442 ( 6x)	

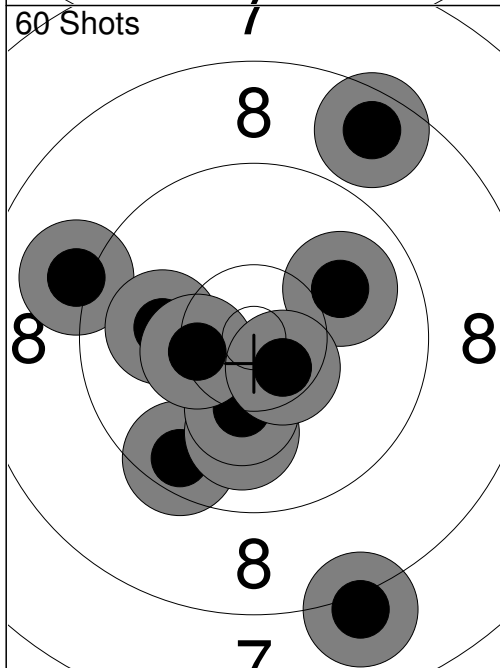

51:	9.6	↙
52:	10.0	↓
53:	9.1	←
54:	8.1	↓
55:	8.6	↗
56:	10.3	↓
57:	10.0	↗
58:	10.0	←
59:	10.4x	↖
60:	10.5x	↘
Series	94 ( 2x)	
	536 ( 8x)	

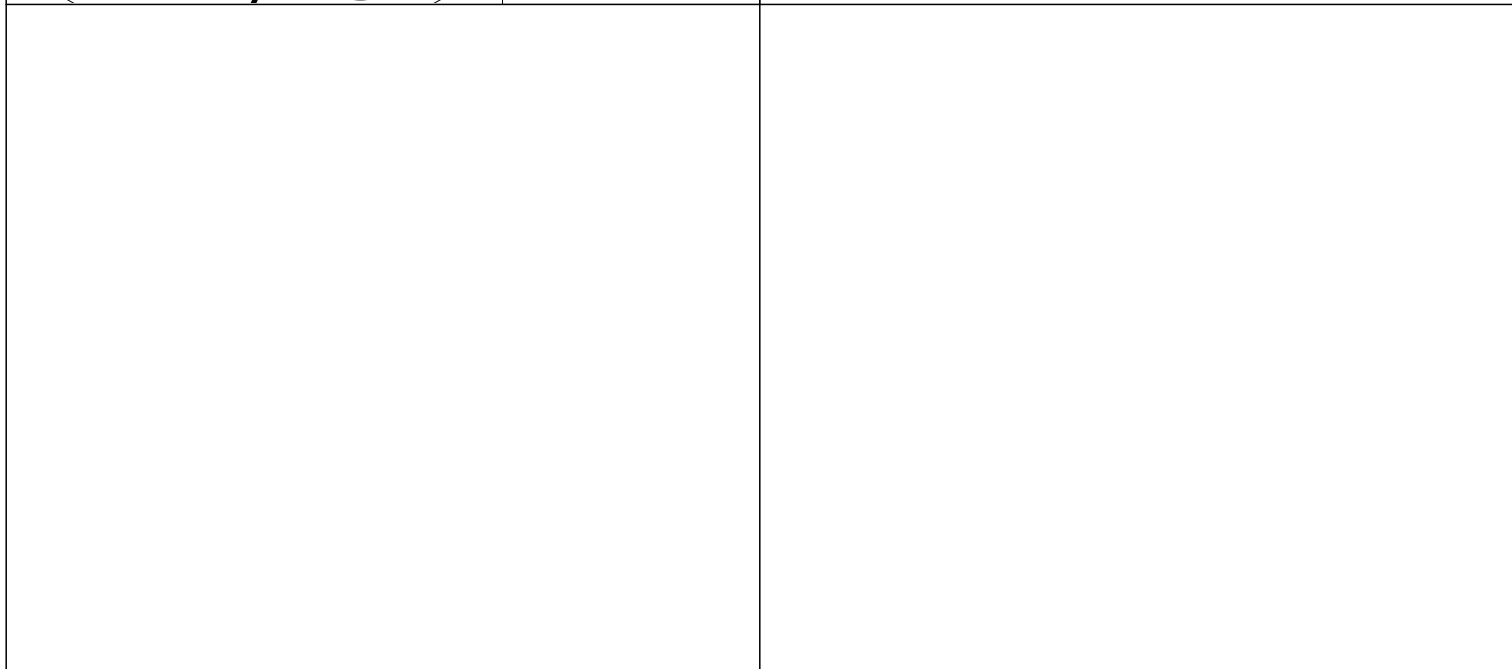

Relay <b>1</b>	Lane <b>10</b>	<b>BRITTON Kim</b>
-------------------	-------------------	--------------------

2023 Western Cdn Air Gun AB	SR	WP
-----------------------------	----	----

14.10.2023	2023 WCAGC Qualifier	Alberta Handgun Association
------------	----------------------	-----------------------------

Comment	Signature
---------	-----------

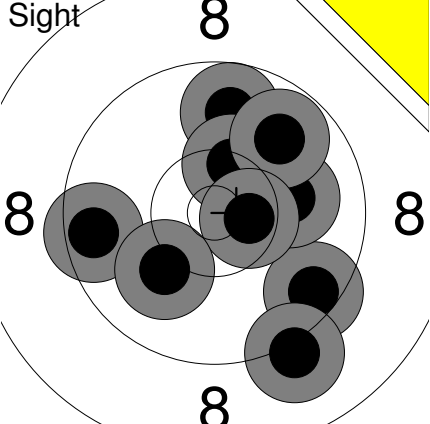
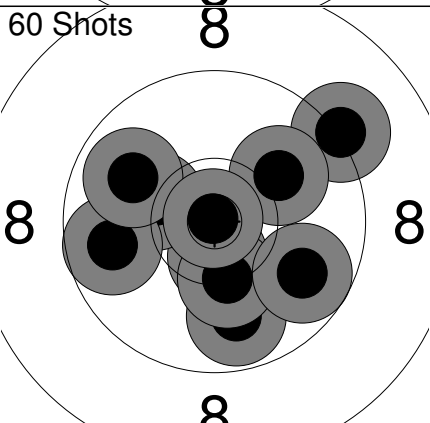
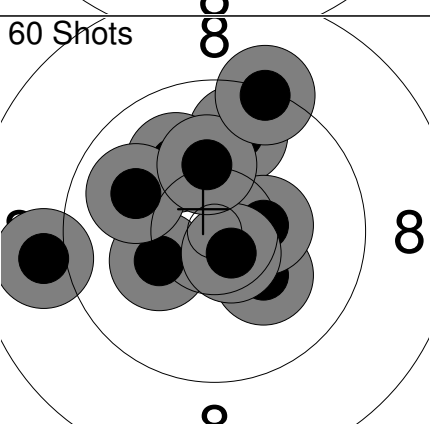
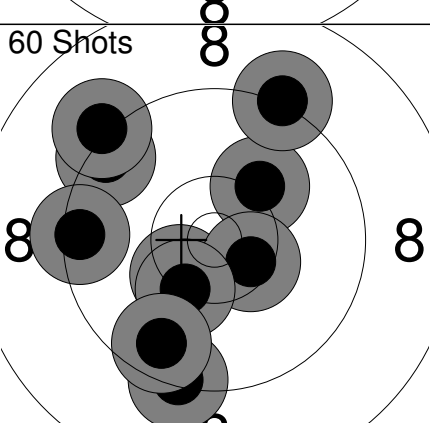
<p>Sight</p> 	<p>60 Shots</p> 	<p>60 Shots</p> 	<p>60 Shots</p> 																																																																																																																									
<table border="1" style="width:100%; border-collapse: collapse;"> <tr><td>1: 9.5</td><td>↘</td></tr> <tr><td>2: 10.0</td><td>↗</td></tr> <tr><td>3: 9.8</td><td>↑</td></tr> <tr><td>4: 9.6</td><td>←</td></tr> <tr><td>5: 10.1</td><td>→</td></tr> <tr><td>6: 10.4x</td><td>↗</td></tr> <tr><td>7: 9.8</td><td>↗</td></tr> <tr><td>8: 9.1</td><td>↘</td></tr> <tr><td>9: 10.6x</td><td>→</td></tr> <tr><td>10: 10.1</td><td>↙</td></tr> <tr><td colspan="2">Series 95 (2x)</td></tr> <tr><td colspan="2">0 (0x)</td></tr> </table>	1: 9.5	↘	2: 10.0	↗	3: 9.8	↑	4: 9.6	←	5: 10.1	→	6: 10.4x	↗	7: 9.8	↗	8: 9.1	↘	9: 10.6x	→	10: 10.1	↙	Series 95 (2x)		0 (0x)		<table border="1" style="width:100%; border-collapse: collapse;"> <tr><td>11: 9.2</td><td>↗</td></tr> <tr><td>12: 9.8</td><td>↘</td></tr> <tr><td>13: 10.5x</td><td>↘</td></tr> <tr><td>14: 10.2</td><td>←</td></tr> <tr><td>15: 9.8</td><td>←</td></tr> <tr><td>16: 10.3</td><td>↘</td></tr> <tr><td>17: 10.0</td><td>↗</td></tr> <tr><td>18: 9.8</td><td>↘</td></tr> <tr><td>19: 9.9</td><td>↗</td></tr> <tr><td>20: 10.9x</td><td>↗</td></tr> <tr><td colspan="2">Series 95 (2x)</td></tr> <tr><td colspan="2">189 (4x)</td></tr> </table>	11: 9.2	↗	12: 9.8	↘	13: 10.5x	↘	14: 10.2	←	15: 9.8	←	16: 10.3	↘	17: 10.0	↗	18: 9.8	↘	19: 9.9	↗	20: 10.9x	↗	Series 95 (2x)		189 (4x)		<table border="1" style="width:100%; border-collapse: collapse;"> <tr><td>21: 10.2</td><td>↗</td></tr> <tr><td>22: 10.2</td><td>←</td></tr> <tr><td>23: 9.9</td><td>↑</td></tr> <tr><td>24: 6.8</td><td>↑</td></tr> <tr><td>25: 10.5x</td><td>↑</td></tr> <tr><td>26: 9.9</td><td>→</td></tr> <tr><td>27: 8.6</td><td>↗</td></tr> <tr><td>28: 9.1</td><td>↘</td></tr> <tr><td>29: 9.4</td><td>↗</td></tr> <tr><td>30: 9.5</td><td>↙</td></tr> <tr><td colspan="2">Series 89 (1x)</td></tr> <tr><td colspan="2">278 (5x)</td></tr> </table>	21: 10.2	↗	22: 10.2	←	23: 9.9	↑	24: 6.8	↑	25: 10.5x	↑	26: 9.9	→	27: 8.6	↗	28: 9.1	↘	29: 9.4	↗	30: 9.5	↙	Series 89 (1x)		278 (5x)		<table border="1" style="width:100%; border-collapse: collapse;"> <tr><td>31: 9.8</td><td>↑</td></tr> <tr><td>32: 10.2</td><td>↘</td></tr> <tr><td>33: 10.2</td><td>←</td></tr> <tr><td>34: 10.4x</td><td>→</td></tr> <tr><td>35: 10.1</td><td>↗</td></tr> <tr><td>36: 9.0</td><td>←</td></tr> <tr><td>37: 10.0</td><td>↗</td></tr> <tr><td>38: 10.6x</td><td>↘</td></tr> <tr><td>39: 10.2</td><td>↑</td></tr> <tr><td>40: 9.3</td><td>↑</td></tr> <tr><td colspan="2">Series 97 (2x)</td></tr> <tr><td colspan="2">375 (7x)</td></tr> </table>	31: 9.8	↑	32: 10.2	↘	33: 10.2	←	34: 10.4x	→	35: 10.1	↗	36: 9.0	←	37: 10.0	↗	38: 10.6x	↘	39: 10.2	↑	40: 9.3	↑	Series 97 (2x)		375 (7x)		<table border="1" style="width:100%; border-collapse: collapse;"> <tr><td>41: 10.2</td><td>↘</td></tr> <tr><td>42: 9.6</td><td>↙</td></tr> <tr><td>43: 10.5x</td><td>↘</td></tr> <tr><td>44: 10.3</td><td>↘</td></tr> <tr><td>45: 9.7</td><td>↘</td></tr> <tr><td>46: 10.4x</td><td>→</td></tr> <tr><td>47: 9.8</td><td>→</td></tr> <tr><td>48: 9.1</td><td>↗</td></tr> <tr><td>49: 10.0</td><td>→</td></tr> <tr><td>50: 9.0</td><td>↘</td></tr> <tr><td colspan="2">Series 95 (2x)</td></tr> <tr><td colspan="2">470 (9x)</td></tr> </table>	41: 10.2	↘	42: 9.6	↙	43: 10.5x	↘	44: 10.3	↘	45: 9.7	↘	46: 10.4x	→	47: 9.8	→	48: 9.1	↗	49: 10.0	→	50: 9.0	↘	Series 95 (2x)		470 (9x)	
1: 9.5	↘																																																																																																																											
2: 10.0	↗																																																																																																																											
3: 9.8	↑																																																																																																																											
4: 9.6	←																																																																																																																											
5: 10.1	→																																																																																																																											
6: 10.4x	↗																																																																																																																											
7: 9.8	↗																																																																																																																											
8: 9.1	↘																																																																																																																											
9: 10.6x	→																																																																																																																											
10: 10.1	↙																																																																																																																											
Series 95 (2x)																																																																																																																												
0 (0x)																																																																																																																												
11: 9.2	↗																																																																																																																											
12: 9.8	↘																																																																																																																											
13: 10.5x	↘																																																																																																																											
14: 10.2	←																																																																																																																											
15: 9.8	←																																																																																																																											
16: 10.3	↘																																																																																																																											
17: 10.0	↗																																																																																																																											
18: 9.8	↘																																																																																																																											
19: 9.9	↗																																																																																																																											
20: 10.9x	↗																																																																																																																											
Series 95 (2x)																																																																																																																												
189 (4x)																																																																																																																												
21: 10.2	↗																																																																																																																											
22: 10.2	←																																																																																																																											
23: 9.9	↑																																																																																																																											
24: 6.8	↑																																																																																																																											
25: 10.5x	↑																																																																																																																											
26: 9.9	→																																																																																																																											
27: 8.6	↗																																																																																																																											
28: 9.1	↘																																																																																																																											
29: 9.4	↗																																																																																																																											
30: 9.5	↙																																																																																																																											
Series 89 (1x)																																																																																																																												
278 (5x)																																																																																																																												
31: 9.8	↑																																																																																																																											
32: 10.2	↘																																																																																																																											
33: 10.2	←																																																																																																																											
34: 10.4x	→																																																																																																																											
35: 10.1	↗																																																																																																																											
36: 9.0	←																																																																																																																											
37: 10.0	↗																																																																																																																											
38: 10.6x	↘																																																																																																																											
39: 10.2	↑																																																																																																																											
40: 9.3	↑																																																																																																																											
Series 97 (2x)																																																																																																																												
375 (7x)																																																																																																																												
41: 10.2	↘																																																																																																																											
42: 9.6	↙																																																																																																																											
43: 10.5x	↘																																																																																																																											
44: 10.3	↘																																																																																																																											
45: 9.7	↘																																																																																																																											
46: 10.4x	→																																																																																																																											
47: 9.8	→																																																																																																																											
48: 9.1	↗																																																																																																																											
49: 10.0	→																																																																																																																											
50: 9.0	↘																																																																																																																											
Series 95 (2x)																																																																																																																												
470 (9x)																																																																																																																												
<table border="1" style="width:100%; border-collapse: collapse;"> <tr><td>51: 9.4</td><td>↙</td></tr> <tr><td>52: 9.3</td><td>↘</td></tr> <tr><td>53: 10.4x</td><td>↙</td></tr> <tr><td>54: 10.1</td><td>↗</td></tr> <tr><td>55: 10.5x</td><td>↘</td></tr> <tr><td>56: 9.2</td><td>↗</td></tr> <tr><td>57: 10.3</td><td>↘</td></tr> <tr><td>58: 9.6</td><td>↘</td></tr> <tr><td>59: 9.4</td><td>←</td></tr> <tr><td>60: 9.2</td><td>↗</td></tr> <tr><td colspan="2">Series 94 (2x)</td></tr> <tr><td colspan="2">564 (11x)</td></tr> </table>	51: 9.4	↙	52: 9.3	↘	53: 10.4x	↙	54: 10.1	↗	55: 10.5x	↘	56: 9.2	↗	57: 10.3	↘	58: 9.6	↘	59: 9.4	←	60: 9.2	↗	Series 94 (2x)		564 (11x)																																																																																																					
51: 9.4	↙																																																																																																																											
52: 9.3	↘																																																																																																																											
53: 10.4x	↙																																																																																																																											
54: 10.1	↗																																																																																																																											
55: 10.5x	↘																																																																																																																											
56: 9.2	↗																																																																																																																											
57: 10.3	↘																																																																																																																											
58: 9.6	↘																																																																																																																											
59: 9.4	←																																																																																																																											
60: 9.2	↗																																																																																																																											
Series 94 (2x)																																																																																																																												
564 (11x)																																																																																																																												

<p>Sight</p>	<table border="1" style="width:100%; border-collapse: collapse;"> <tr><td>1:</td><td>9.7</td><td>↗</td></tr> <tr><td>2:</td><td>10.6x</td><td>↗</td></tr> <tr><td>3:</td><td>10.5x</td><td>→</td></tr> <tr><td>4:</td><td>9.1</td><td>↘</td></tr> <tr><td colspan="2">Series</td><td>39.9</td></tr> <tr><td colspan="2"></td><td>0.0</td></tr> </table>	1:	9.7	↗	2:	10.6x	↗	3:	10.5x	→	4:	9.1	↘	Series		39.9			0.0	<p>60 Shots</p>	<table border="1" style="width:100%; border-collapse: collapse;"> <tr><td>1:</td><td>9.9</td><td>←</td></tr> <tr><td>2:</td><td>9.8</td><td>←</td></tr> <tr><td>3:</td><td>8.8</td><td>↘</td></tr> <tr><td>4:</td><td>10.0</td><td>←</td></tr> <tr><td>5:</td><td>10.0</td><td>←</td></tr> <tr><td>6:</td><td>9.2</td><td>↓</td></tr> <tr><td>7:</td><td>9.3</td><td>→</td></tr> <tr><td>8:</td><td>9.2</td><td>→</td></tr> <tr><td>9:</td><td>10.0</td><td>←</td></tr> <tr><td>10:</td><td>10.5x</td><td>↓</td></tr> <tr><td colspan="2">Series</td><td>96.7</td></tr> <tr><td colspan="2"></td><td>96.7</td></tr> </table>	1:	9.9	←	2:	9.8	←	3:	8.8	↘	4:	10.0	←	5:	10.0	←	6:	9.2	↓	7:	9.3	→	8:	9.2	→	9:	10.0	←	10:	10.5x	↓	Series		96.7			96.7																		
1:	9.7	↗																																																																									
2:	10.6x	↗																																																																									
3:	10.5x	→																																																																									
4:	9.1	↘																																																																									
Series		39.9																																																																									
		0.0																																																																									
1:	9.9	←																																																																									
2:	9.8	←																																																																									
3:	8.8	↘																																																																									
4:	10.0	←																																																																									
5:	10.0	←																																																																									
6:	9.2	↓																																																																									
7:	9.3	→																																																																									
8:	9.2	→																																																																									
9:	10.0	←																																																																									
10:	10.5x	↓																																																																									
Series		96.7																																																																									
		96.7																																																																									
<p>60 Shots</p>	<table border="1" style="width:100%; border-collapse: collapse;"> <tr><td>11:</td><td>10.1</td><td>↗</td></tr> <tr><td>12:</td><td>8.9</td><td>←</td></tr> <tr><td>13:</td><td>10.4x</td><td>↑</td></tr> <tr><td>14:</td><td>10.0</td><td>↘</td></tr> <tr><td>15:</td><td>9.4</td><td>↗</td></tr> <tr><td>16:</td><td>9.3</td><td>←</td></tr> <tr><td>17:</td><td>6.9</td><td>↓</td></tr> <tr><td>18:</td><td>9.3</td><td>↓</td></tr> <tr><td>19:</td><td>9.7</td><td>↗</td></tr> <tr><td>20:</td><td>8.9</td><td>↘</td></tr> <tr><td colspan="2">Series</td><td>92.9</td></tr> <tr><td colspan="2"></td><td>189.6</td></tr> </table>	11:	10.1	↗	12:	8.9	←	13:	10.4x	↑	14:	10.0	↘	15:	9.4	↗	16:	9.3	←	17:	6.9	↓	18:	9.3	↓	19:	9.7	↗	20:	8.9	↘	Series		92.9			189.6	<p>60 Shots</p>	<table border="1" style="width:100%; border-collapse: collapse;"> <tr><td>21:</td><td>10.3x</td><td>↗</td></tr> <tr><td>22:</td><td>9.0</td><td>←</td></tr> <tr><td>23:</td><td>8.8</td><td>↗</td></tr> <tr><td>24:</td><td>9.7</td><td>↘</td></tr> <tr><td>25:</td><td>9.0</td><td>↘</td></tr> <tr><td>26:</td><td>9.7</td><td>↘</td></tr> <tr><td>27:</td><td>10.4x</td><td>↓</td></tr> <tr><td>28:</td><td>10.7x</td><td>↓</td></tr> <tr><td>29:</td><td>8.8</td><td>→</td></tr> <tr><td>30:</td><td>9.7</td><td>→</td></tr> <tr><td colspan="2">Series</td><td>96.1</td></tr> <tr><td colspan="2"></td><td>285.7</td></tr> </table>	21:	10.3x	↗	22:	9.0	←	23:	8.8	↗	24:	9.7	↘	25:	9.0	↘	26:	9.7	↘	27:	10.4x	↓	28:	10.7x	↓	29:	8.8	→	30:	9.7	→	Series		96.1			285.7
11:	10.1	↗																																																																									
12:	8.9	←																																																																									
13:	10.4x	↑																																																																									
14:	10.0	↘																																																																									
15:	9.4	↗																																																																									
16:	9.3	←																																																																									
17:	6.9	↓																																																																									
18:	9.3	↓																																																																									
19:	9.7	↗																																																																									
20:	8.9	↘																																																																									
Series		92.9																																																																									
		189.6																																																																									
21:	10.3x	↗																																																																									
22:	9.0	←																																																																									
23:	8.8	↗																																																																									
24:	9.7	↘																																																																									
25:	9.0	↘																																																																									
26:	9.7	↘																																																																									
27:	10.4x	↓																																																																									
28:	10.7x	↓																																																																									
29:	8.8	→																																																																									
30:	9.7	→																																																																									
Series		96.1																																																																									
		285.7																																																																									
<p>60 Shots</p>	<table border="1" style="width:100%; border-collapse: collapse;"> <tr><td>31:</td><td>10.4x</td><td>↑</td></tr> <tr><td>32:</td><td>9.2</td><td>←</td></tr> <tr><td>33:</td><td>9.9</td><td>↘</td></tr> <tr><td>34:</td><td>9.1</td><td>←</td></tr> <tr><td>35:</td><td>8.7</td><td>←</td></tr> <tr><td>36:</td><td>8.9</td><td>→</td></tr> <tr><td>37:</td><td>10.6x</td><td>↗</td></tr> <tr><td>38:</td><td>10.8x</td><td>↘</td></tr> <tr><td>39:</td><td>5.5</td><td>→</td></tr> <tr><td>40:</td><td>10.1</td><td>↓</td></tr> <tr><td colspan="2">Series</td><td>93.2</td></tr> <tr><td colspan="2"></td><td>378.9</td></tr> </table>	31:	10.4x	↑	32:	9.2	←	33:	9.9	↘	34:	9.1	←	35:	8.7	←	36:	8.9	→	37:	10.6x	↗	38:	10.8x	↘	39:	5.5	→	40:	10.1	↓	Series		93.2			378.9	<p>60 Shots</p>	<table border="1" style="width:100%; border-collapse: collapse;"> <tr><td>41:</td><td>9.1</td><td>↘</td></tr> <tr><td>42:</td><td>10.4x</td><td>↗</td></tr> <tr><td>43:</td><td>9.3</td><td>→</td></tr> <tr><td>44:</td><td>9.2</td><td>→</td></tr> <tr><td>45:</td><td>8.6</td><td>→</td></tr> <tr><td>46:</td><td>10.4x</td><td>↓</td></tr> <tr><td>47:</td><td>10.2x</td><td>↘</td></tr> <tr><td>48:</td><td>10.6x</td><td>↓</td></tr> <tr><td>49:</td><td>9.2</td><td>↓</td></tr> <tr><td>50:</td><td>9.7</td><td>↘</td></tr> <tr><td colspan="2">Series</td><td>96.7</td></tr> <tr><td colspan="2"></td><td>475.6</td></tr> </table>	41:	9.1	↘	42:	10.4x	↗	43:	9.3	→	44:	9.2	→	45:	8.6	→	46:	10.4x	↓	47:	10.2x	↘	48:	10.6x	↓	49:	9.2	↓	50:	9.7	↘	Series		96.7			475.6
31:	10.4x	↑																																																																									
32:	9.2	←																																																																									
33:	9.9	↘																																																																									
34:	9.1	←																																																																									
35:	8.7	←																																																																									
36:	8.9	→																																																																									
37:	10.6x	↗																																																																									
38:	10.8x	↘																																																																									
39:	5.5	→																																																																									
40:	10.1	↓																																																																									
Series		93.2																																																																									
		378.9																																																																									
41:	9.1	↘																																																																									
42:	10.4x	↗																																																																									
43:	9.3	→																																																																									
44:	9.2	→																																																																									
45:	8.6	→																																																																									
46:	10.4x	↓																																																																									
47:	10.2x	↘																																																																									
48:	10.6x	↓																																																																									
49:	9.2	↓																																																																									
50:	9.7	↘																																																																									
Series		96.7																																																																									
		475.6																																																																									
<p>60 Shots</p>	<table border="1" style="width:100%; border-collapse: collapse;"> <tr><td>51:</td><td>10.4x</td><td>↑</td></tr> <tr><td>52:</td><td>8.7</td><td>→</td></tr> <tr><td>53:</td><td>10.3x</td><td>←</td></tr> <tr><td>54:</td><td>8.9</td><td>↘</td></tr> <tr><td>55:</td><td>9.3</td><td>→</td></tr> <tr><td>56:</td><td>9.1</td><td>→</td></tr> <tr><td>57:</td><td>10.1</td><td>←</td></tr> <tr><td>58:</td><td>10.4x</td><td>←</td></tr> <tr><td>59:</td><td>8.5</td><td>←</td></tr> <tr><td>60:</td><td>10.5x</td><td>↘</td></tr> <tr><td colspan="2">Series</td><td>96.2</td></tr> <tr><td colspan="2"></td><td>571.8</td></tr> </table>	51:	10.4x	↑	52:	8.7	→	53:	10.3x	←	54:	8.9	↘	55:	9.3	→	56:	9.1	→	57:	10.1	←	58:	10.4x	←	59:	8.5	←	60:	10.5x	↘	Series		96.2			571.8																																						
51:	10.4x	↑																																																																									
52:	8.7	→																																																																									
53:	10.3x	←																																																																									
54:	8.9	↘																																																																									
55:	9.3	→																																																																									
56:	9.1	→																																																																									
57:	10.1	←																																																																									
58:	10.4x	←																																																																									
59:	8.5	←																																																																									
60:	10.5x	↘																																																																									
Series		96.2																																																																									
		571.8																																																																									

Comment	Signature
---------	-----------

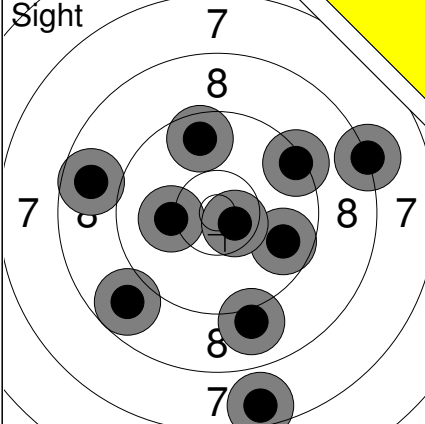
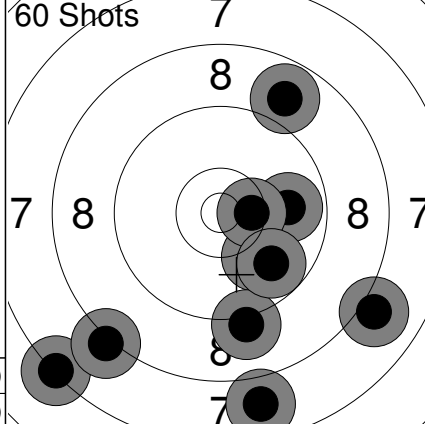
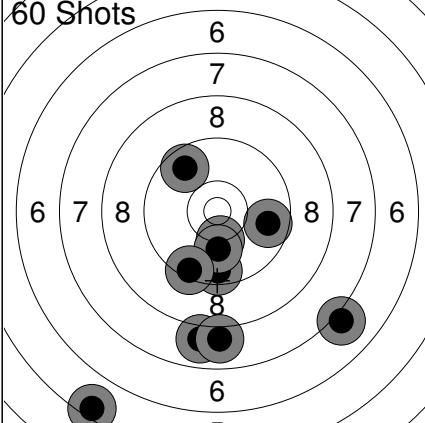
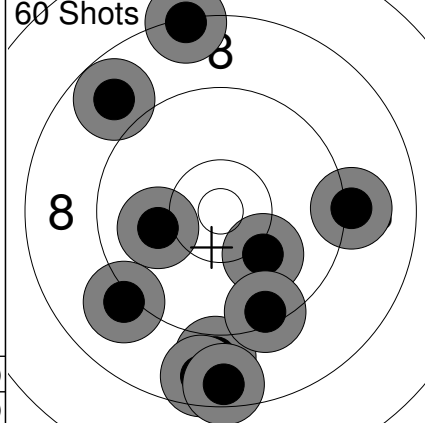
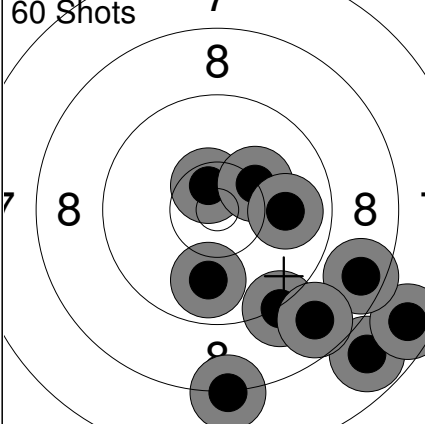
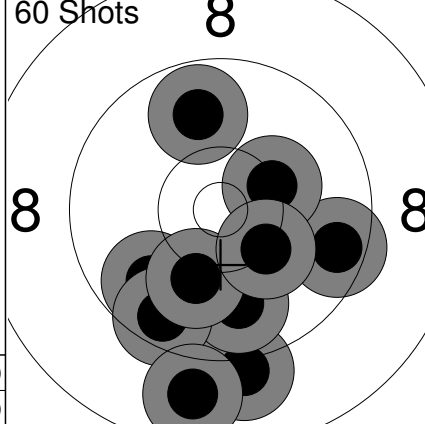
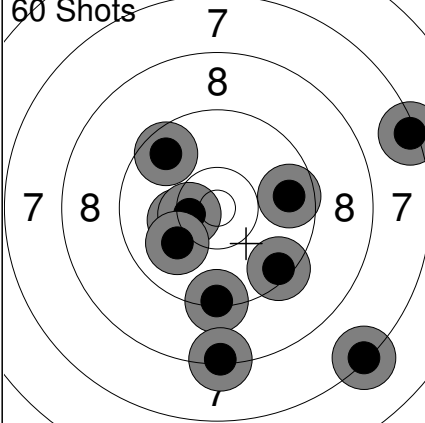
<p>Sight</p> 	<table border="1" style="width:100%; border-collapse: collapse;"> <tr><td>1:</td><td>8.2</td><td>→</td></tr> <tr><td>2:</td><td>9.7</td><td>↗</td></tr> <tr><td>3:</td><td>7.6</td><td>↘</td></tr> <tr><td>4:</td><td>8.7</td><td>←</td></tr> <tr><td>5:</td><td>9.7</td><td>→</td></tr> <tr><td>6:</td><td>10.2</td><td>←</td></tr> <tr><td>7:</td><td>8.8</td><td>↘</td></tr> <tr><td>8:</td><td>9.0</td><td>↘</td></tr> <tr><td>9:</td><td>10.6x</td><td>↘</td></tr> <tr><td>10:</td><td>9.4</td><td>↗</td></tr> <tr><td colspan="2">Series</td><td>87 ( 1x)</td></tr> <tr><td colspan="2"></td><td>0 ( 0x)</td></tr> </table>	1:	8.2	→	2:	9.7	↗	3:	7.6	↘	4:	8.7	←	5:	9.7	→	6:	10.2	←	7:	8.8	↘	8:	9.0	↘	9:	10.6x	↘	10:	9.4	↗	Series		87 ( 1x)			0 ( 0x)	<p>60 Shots</p> 	<table border="1" style="width:100%; border-collapse: collapse;"> <tr><td>1:</td><td>7.3</td><td>↙</td></tr> <tr><td>2:</td><td>8.1</td><td>↙</td></tr> <tr><td>3:</td><td>10.0</td><td>↘</td></tr> <tr><td>4:</td><td>9.9</td><td>→</td></tr> <tr><td>5:</td><td>8.8</td><td>↗</td></tr> <tr><td>6:</td><td>7.8</td><td>↘</td></tr> <tr><td>7:</td><td>8.0</td><td>↘</td></tr> <tr><td>8:</td><td>10.4x</td><td>→</td></tr> <tr><td>9:</td><td>9.1</td><td>↘</td></tr> <tr><td>10:</td><td>9.8</td><td>↘</td></tr> <tr><td colspan="2">Series</td><td>85 ( 1x)</td></tr> <tr><td colspan="2"></td><td>85 ( 1x)</td></tr> </table>	1:	7.3	↙	2:	8.1	↙	3:	10.0	↘	4:	9.9	→	5:	8.8	↗	6:	7.8	↘	7:	8.0	↘	8:	10.4x	→	9:	9.1	↘	10:	9.8	↘	Series		85 ( 1x)			85 ( 1x)
1:	8.2	→																																																																									
2:	9.7	↗																																																																									
3:	7.6	↘																																																																									
4:	8.7	←																																																																									
5:	9.7	→																																																																									
6:	10.2	←																																																																									
7:	8.8	↘																																																																									
8:	9.0	↘																																																																									
9:	10.6x	↘																																																																									
10:	9.4	↗																																																																									
Series		87 ( 1x)																																																																									
		0 ( 0x)																																																																									
1:	7.3	↙																																																																									
2:	8.1	↙																																																																									
3:	10.0	↘																																																																									
4:	9.9	→																																																																									
5:	8.8	↗																																																																									
6:	7.8	↘																																																																									
7:	8.0	↘																																																																									
8:	10.4x	→																																																																									
9:	9.1	↘																																																																									
10:	9.8	↘																																																																									
Series		85 ( 1x)																																																																									
		85 ( 1x)																																																																									
<p>60 Shots</p> 	<table border="1" style="width:100%; border-collapse: collapse;"> <tr><td>11:</td><td>9.5</td><td>↓</td></tr> <tr><td>12:</td><td>7.9</td><td>↓</td></tr> <tr><td>13:</td><td>7.9</td><td>↓</td></tr> <tr><td>14:</td><td>10.3</td><td>↓</td></tr> <tr><td>15:</td><td>5.5</td><td>↓</td></tr> <tr><td>16:</td><td>10.1</td><td>↓</td></tr> <tr><td>17:</td><td>7.1</td><td>↘</td></tr> <tr><td>18:</td><td>9.4</td><td>↘</td></tr> <tr><td>19:</td><td>9.7</td><td>→</td></tr> <tr><td>20:</td><td>9.7</td><td>↗</td></tr> <tr><td colspan="2">Series</td><td>82 ( 0x)</td></tr> <tr><td colspan="2"></td><td>167 ( 1x)</td></tr> </table>	11:	9.5	↓	12:	7.9	↓	13:	7.9	↓	14:	10.3	↓	15:	5.5	↓	16:	10.1	↓	17:	7.1	↘	18:	9.4	↘	19:	9.7	→	20:	9.7	↗	Series		82 ( 0x)			167 ( 1x)	<p>60 Shots</p> 	<table border="1" style="width:100%; border-collapse: collapse;"> <tr><td>21:</td><td>10.0</td><td>←</td></tr> <tr><td>22:</td><td>8.9</td><td>↓</td></tr> <tr><td>23:</td><td>8.3</td><td>↗</td></tr> <tr><td>24:</td><td>9.1</td><td>↙</td></tr> <tr><td>25:</td><td>9.1</td><td>→</td></tr> <tr><td>26:</td><td>10.1</td><td>↘</td></tr> <tr><td>27:</td><td>9.4</td><td>↘</td></tr> <tr><td>28:</td><td>8.8</td><td>↗</td></tr> <tr><td>29:</td><td>8.6</td><td>↓</td></tr> <tr><td>30:</td><td>8.5</td><td>↓</td></tr> <tr><td colspan="2">Series</td><td>87 ( 0x)</td></tr> <tr><td colspan="2"></td><td>254 ( 1x)</td></tr> </table>	21:	10.0	←	22:	8.9	↓	23:	8.3	↗	24:	9.1	↙	25:	9.1	→	26:	10.1	↘	27:	9.4	↘	28:	8.8	↗	29:	8.6	↓	30:	8.5	↓	Series		87 ( 0x)			254 ( 1x)
11:	9.5	↓																																																																									
12:	7.9	↓																																																																									
13:	7.9	↓																																																																									
14:	10.3	↓																																																																									
15:	5.5	↓																																																																									
16:	10.1	↓																																																																									
17:	7.1	↘																																																																									
18:	9.4	↘																																																																									
19:	9.7	→																																																																									
20:	9.7	↗																																																																									
Series		82 ( 0x)																																																																									
		167 ( 1x)																																																																									
21:	10.0	←																																																																									
22:	8.9	↓																																																																									
23:	8.3	↗																																																																									
24:	9.1	↙																																																																									
25:	9.1	→																																																																									
26:	10.1	↘																																																																									
27:	9.4	↘																																																																									
28:	8.8	↗																																																																									
29:	8.6	↓																																																																									
30:	8.5	↓																																																																									
Series		87 ( 0x)																																																																									
		254 ( 1x)																																																																									
<p>60 Shots</p> 	<table border="1" style="width:100%; border-collapse: collapse;"> <tr><td>31:</td><td>9.2</td><td>↘</td></tr> <tr><td>32:</td><td>7.8</td><td>↘</td></tr> <tr><td>33:</td><td>9.9</td><td>↘</td></tr> <tr><td>34:</td><td>7.6</td><td>↘</td></tr> <tr><td>35:</td><td>8.2</td><td>↘</td></tr> <tr><td>36:</td><td>10.6x</td><td>↗</td></tr> <tr><td>37:</td><td>10.3</td><td>→</td></tr> <tr><td>38:</td><td>8.6</td><td>↘</td></tr> <tr><td>39:</td><td>8.7</td><td>↘</td></tr> <tr><td>40:</td><td>9.9</td><td>→</td></tr> <tr><td colspan="2">Series</td><td>85 ( 1x)</td></tr> <tr><td colspan="2"></td><td>339 ( 2x)</td></tr> </table>	31:	9.2	↘	32:	7.8	↘	33:	9.9	↘	34:	7.6	↘	35:	8.2	↘	36:	10.6x	↗	37:	10.3	→	38:	8.6	↘	39:	8.7	↘	40:	9.9	→	Series		85 ( 1x)			339 ( 2x)	<p>60 Shots</p> 	<table border="1" style="width:100%; border-collapse: collapse;"> <tr><td>41:</td><td>9.8</td><td>↙</td></tr> <tr><td>42:</td><td>9.8</td><td>↗</td></tr> <tr><td>43:</td><td>9.1</td><td>↘</td></tr> <tr><td>44:</td><td>9.6</td><td>→</td></tr> <tr><td>45:</td><td>10.3</td><td>→</td></tr> <tr><td>46:</td><td>9.9</td><td>↘</td></tr> <tr><td>47:</td><td>9.6</td><td>↘</td></tr> <tr><td>48:</td><td>10.1</td><td>↘</td></tr> <tr><td>49:</td><td>10.3</td><td>↘</td></tr> <tr><td>50:</td><td>8.8</td><td>↓</td></tr> <tr><td colspan="2">Series</td><td>92 ( 0x)</td></tr> <tr><td colspan="2"></td><td>431 ( 2x)</td></tr> </table>	41:	9.8	↙	42:	9.8	↗	43:	9.1	↘	44:	9.6	→	45:	10.3	→	46:	9.9	↘	47:	9.6	↘	48:	10.1	↘	49:	10.3	↘	50:	8.8	↓	Series		92 ( 0x)			431 ( 2x)
31:	9.2	↘																																																																									
32:	7.8	↘																																																																									
33:	9.9	↘																																																																									
34:	7.6	↘																																																																									
35:	8.2	↘																																																																									
36:	10.6x	↗																																																																									
37:	10.3	→																																																																									
38:	8.6	↘																																																																									
39:	8.7	↘																																																																									
40:	9.9	→																																																																									
Series		85 ( 1x)																																																																									
		339 ( 2x)																																																																									
41:	9.8	↙																																																																									
42:	9.8	↗																																																																									
43:	9.1	↘																																																																									
44:	9.6	→																																																																									
45:	10.3	→																																																																									
46:	9.9	↘																																																																									
47:	9.6	↘																																																																									
48:	10.1	↘																																																																									
49:	10.3	↘																																																																									
50:	8.8	↓																																																																									
Series		92 ( 0x)																																																																									
		431 ( 2x)																																																																									
<p>60 Shots</p> 	<table border="1" style="width:100%; border-collapse: collapse;"> <tr><td>51:</td><td>10.3</td><td>←</td></tr> <tr><td>52:</td><td>9.7</td><td>→</td></tr> <tr><td>53:</td><td>10.5x</td><td>←</td></tr> <tr><td>54:</td><td>9.3</td><td>↓</td></tr> <tr><td>55:</td><td>10.0</td><td>←</td></tr> <tr><td>56:</td><td>8.3</td><td>↓</td></tr> <tr><td>57:</td><td>7.3</td><td>↘</td></tr> <tr><td>58:</td><td>7.3</td><td>→</td></tr> <tr><td>59:</td><td>9.4</td><td>↘</td></tr> <tr><td>60:</td><td>9.6</td><td>↗</td></tr> <tr><td colspan="2">Series</td><td>88 ( 1x)</td></tr> <tr><td colspan="2"></td><td>519 ( 3x)</td></tr> </table>	51:	10.3	←	52:	9.7	→	53:	10.5x	←	54:	9.3	↓	55:	10.0	←	56:	8.3	↓	57:	7.3	↘	58:	7.3	→	59:	9.4	↘	60:	9.6	↗	Series		88 ( 1x)			519 ( 3x)																																						
51:	10.3	←																																																																									
52:	9.7	→																																																																									
53:	10.5x	←																																																																									
54:	9.3	↓																																																																									
55:	10.0	←																																																																									
56:	8.3	↓																																																																									
57:	7.3	↘																																																																									
58:	7.3	→																																																																									
59:	9.4	↘																																																																									
60:	9.6	↗																																																																									
Series		88 ( 1x)																																																																									
		519 ( 3x)																																																																									

Relay **2** Lane **2** **DU Max**

2023 Western Cdn Air Gun AB JR MP

14.10.2023 2023 WCAGC Qualifier Alberta Handgun Association

Comment Signature

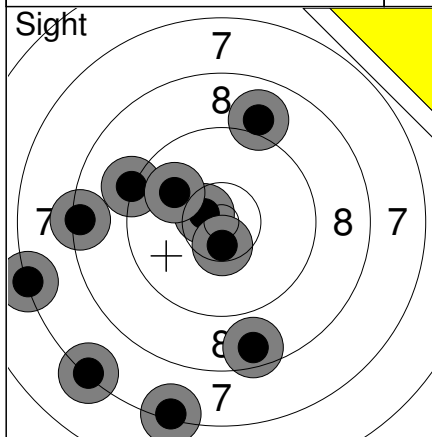

1:	8.4	←
2:	8.6	↙
3:	10.6x	↗
4:	10.5x	↓
5:	7.3	↘
6:	9.2	↗
7:	7.3	←
8:	9.0	↑
9:	9.9	↗
10:	7.3	↘
Series	84 (2x)	
	0 (0x)	

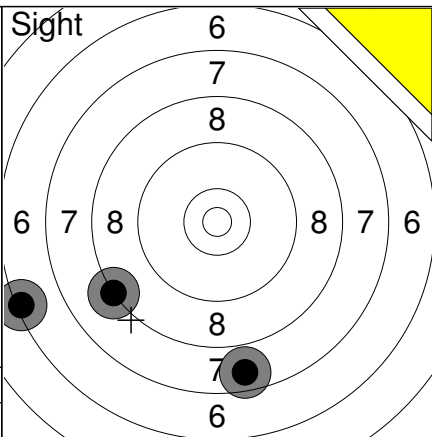

11:	6.3	←
12:	7.6	↓
13:	8.2	↙
Series	21 (0x)	
	0 (0x)	

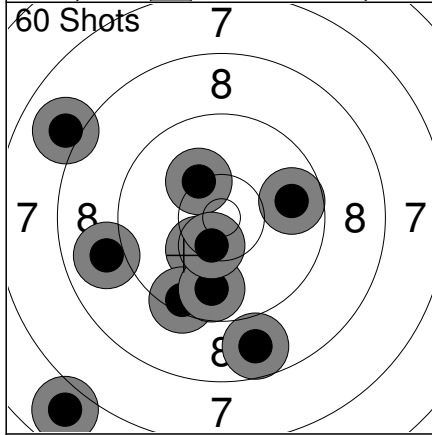

1:	10.3	↙
2:	10.2	↗
3:	8.9	←
4:	9.8	→
5:	9.4	↓
6:	9.8	↘
7:	8.8	↘
8:	8.0	↗
9:	10.5x	↓
10:	6.9	↘
Series	87 (1x)	
	87 (1x)	

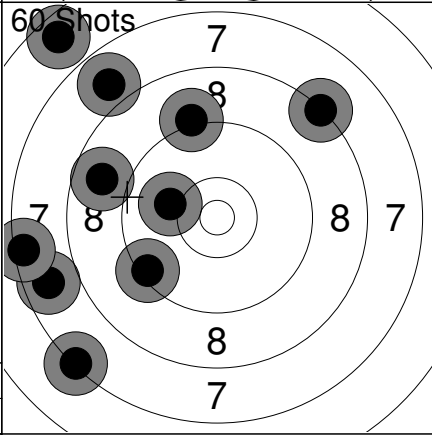

11:	8.3	↗
12:	7.3	↙
13:	8.8	←
14:	7.7	←
15:	7.8	↗
16:	9.1	↑
17:	7.4	←
18:	9.4	↙
19:	6.6	↗
20:	10.1	←
Series	78 (0x)	
	165 (1x)	

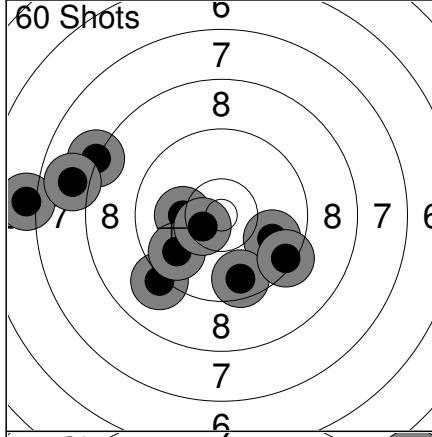

21:	10.2	←
22:	9.8	→
23:	9.1	↙
24:	8.2	←
25:	9.8	↙
26:	7.0	←
27:	7.9	←
28:	10.5x	←
29:	9.6	↓
30:	9.4	↘
Series	87 (1x)	
	252 (2x)	

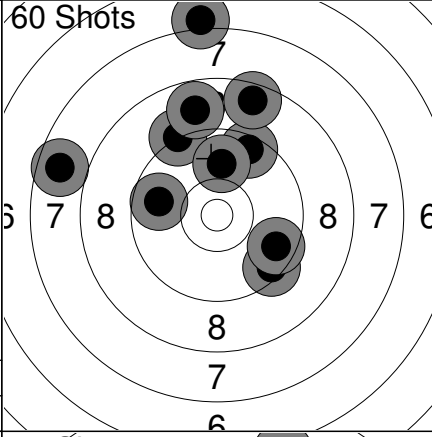

31:	9.8	←
32:	7.7	←
33:	9.2	↑
34:	9.4	↘
35:	9.6	→
36:	9.5	↑
37:	8.6	↑
38:	8.8	↑
39:	7.1	↑
40:	9.9	↑
Series	84 (0x)	
	336 (2x)	

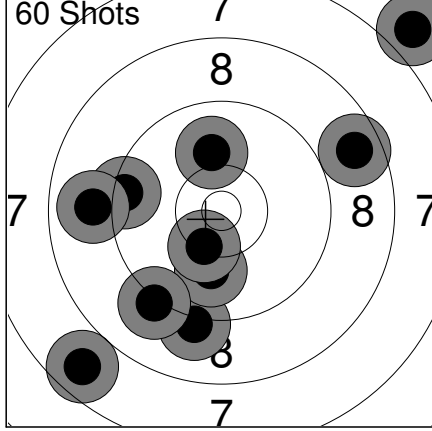

41:	9.1	↓
42:	6.8	↗
43:	10.0	↓
44:	10.0	↑
45:	9.2	↘
46:	9.4	←
47:	10.3	↓
48:	8.9	←
49:	7.7	↘
50:	8.7	→
Series	86 (0x)	
	422 (2x)	

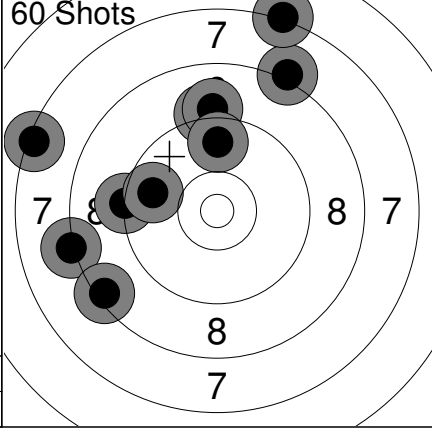

51:	8.1	↑
52:	9.2	←
53:	8.2	←
54:	8.4	↙
55:	7.2	↑
56:	9.2	↑
57:	9.1	↑
58:	9.7	↑
59:	9.7	←
60:	7.4	←
Series	83 (0x)	
	505 (2x)	

Relay <b>2</b>	Lane <b>3</b>	<b>LI Xinyi</b>
-------------------	------------------	-----------------

2023 Western Cdn Air Gun BC	JR	WP
-----------------------------	----	----

14.10.2023	2023 WCAGC Qualifier	Alberta Handgun Association
------------	----------------------	-----------------------------

Comment	Signature
---------	-----------

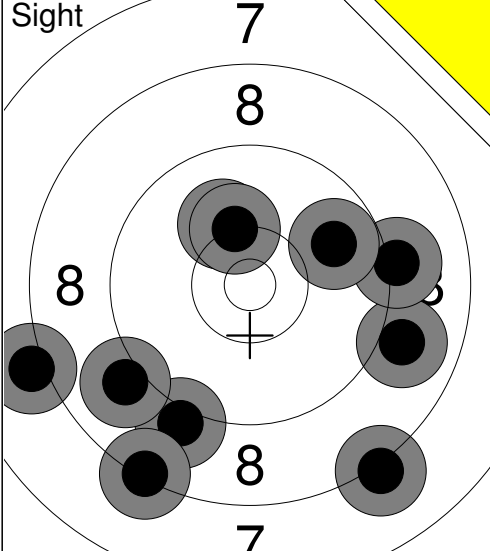
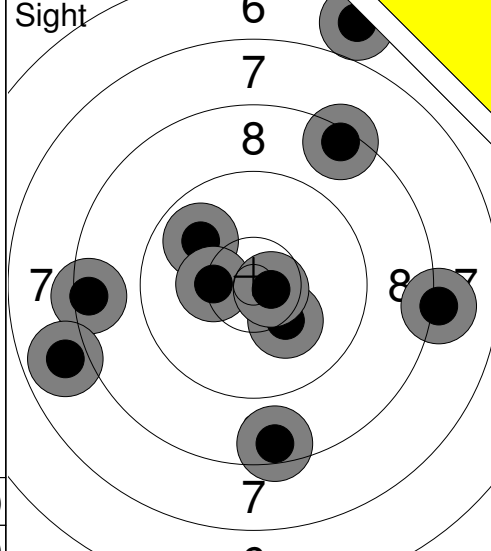
<p>Sight</p> 	<p>Sight</p> 	
---	---	--

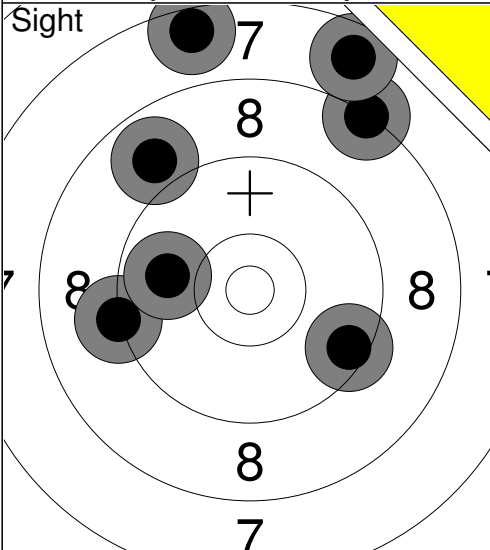
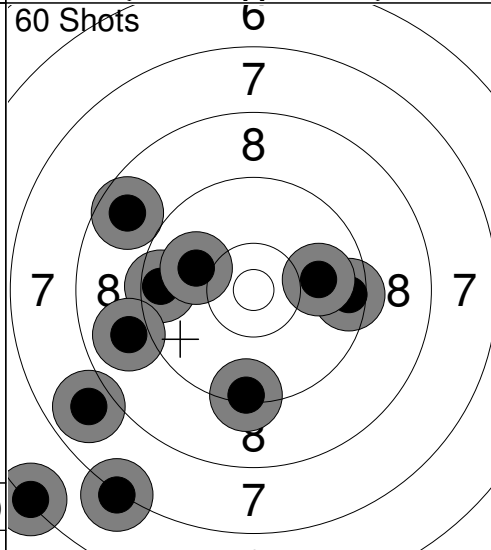
<p>Sight</p> 	<p>60 Shots</p> 	
--	---	--

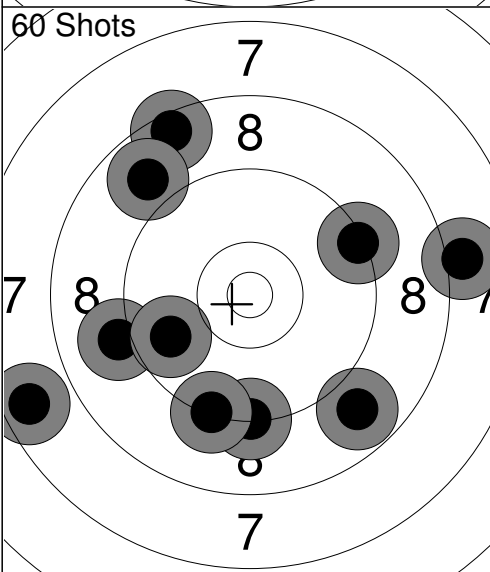
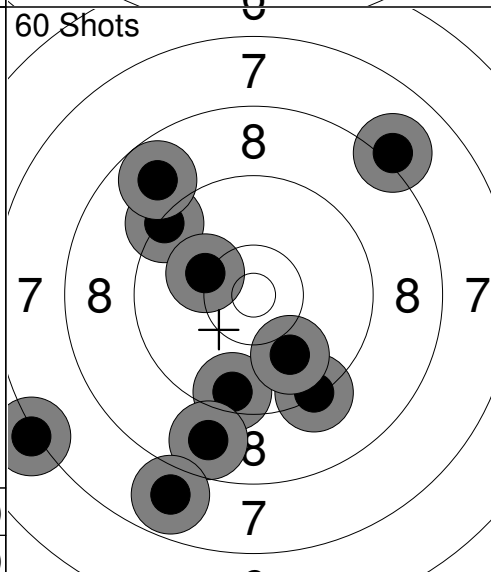
<p>60 Shots</p> 	<p>60 Shots</p> 	
--	--	--

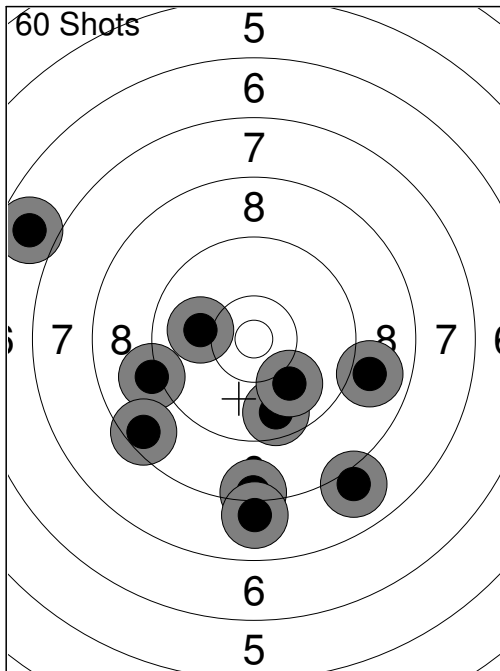

- 31: 8.4 ↓
- 32: 9.7 ↓
- 33: 10.0 ↘
- 34: 8.0 ↓
- 35: 10.0 ←
- 36: 8.0 ↓
- 37: 8.9 →
- 38: 9.1 ←
- 39: 8.5 ↙
- 40: 6.8 ↙

Series 84 ( 0x)  
334 ( 0x)

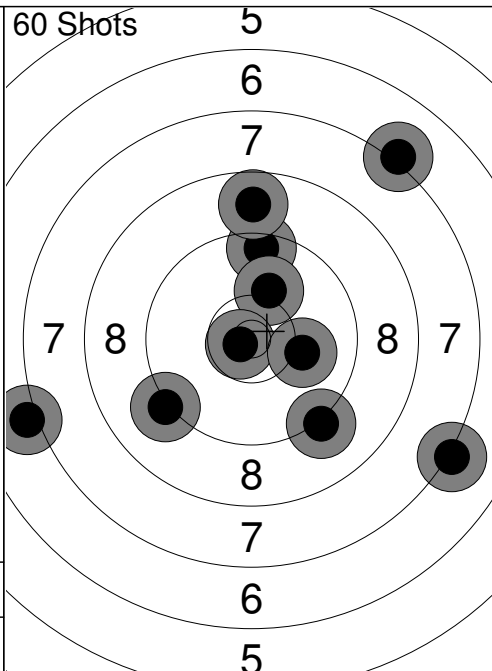

- 41: 7.1 ←
- 42: 9.2 ↘
- 43: 9.5 ↑
- 44: 9.2 ↙
- 45: 7.2 ↘
- 46: 8.8 ↑
- 47: 7.1 ↗
- 48: 10.1 ↑
- 49: 10.7x ↙
- 50: 10.1 →

Series 86 ( 1x)  
420 ( 1x)

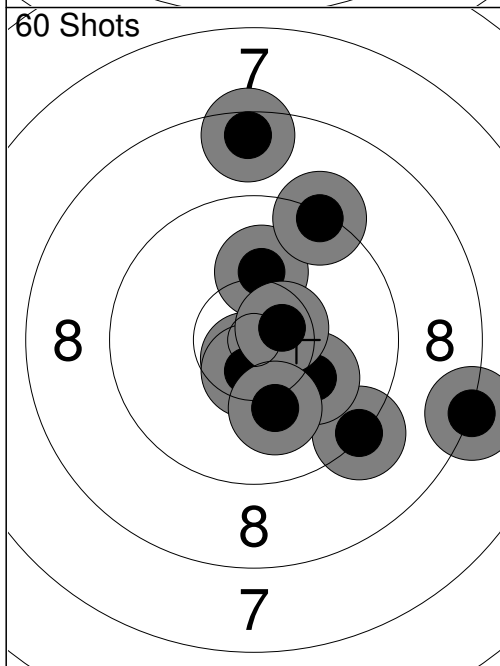

- 51: 8.5 ↑
- 52: 10.1 ↑
- 53: 9.3 ↘
- 54: 10.7x ↓
- 55: 8.2 →
- 56: 10.1 ↘
- 57: 9.3 ↗
- 58: 10.6x ↓
- 59: 10.6x ↗
- 60: 10.1 ↓

Series 94 ( 3x)  
514 ( 4x)



Relay **2** Lane **4** **ZHAO Amanda**

2023 Western Cdn Air Gun BC JR WP

14.10.2023 2023 WCAGC Qualifier Alberta Handgun Association

Comment Signature

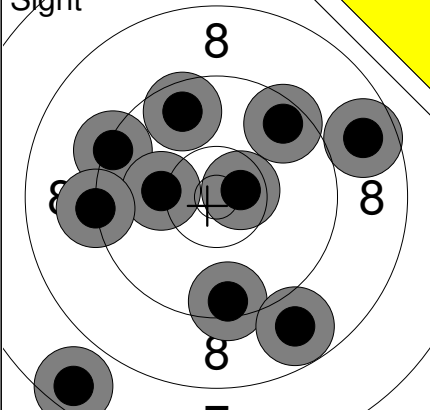
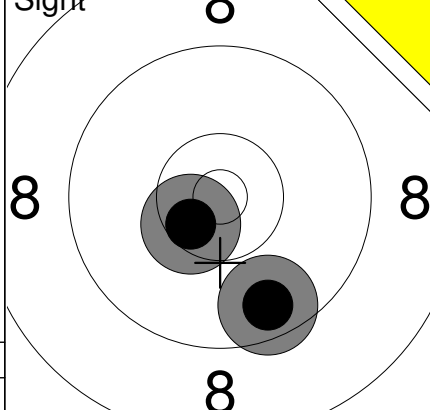
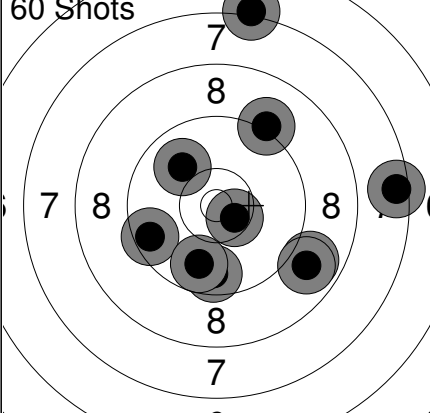
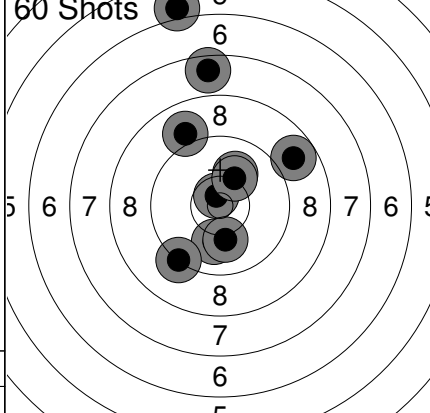
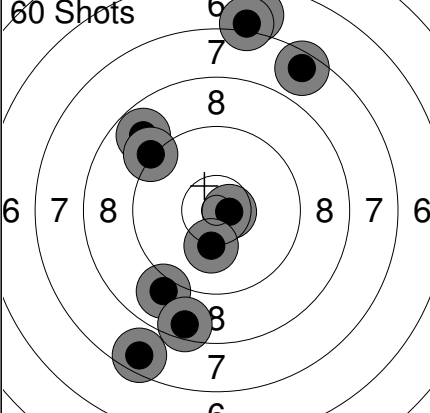
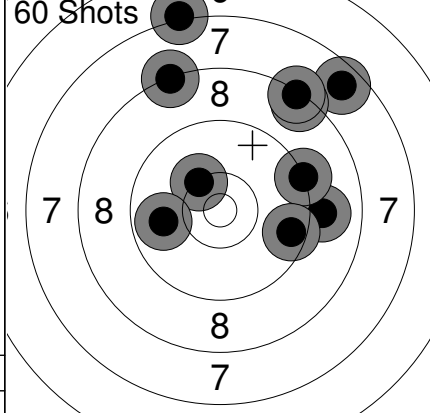
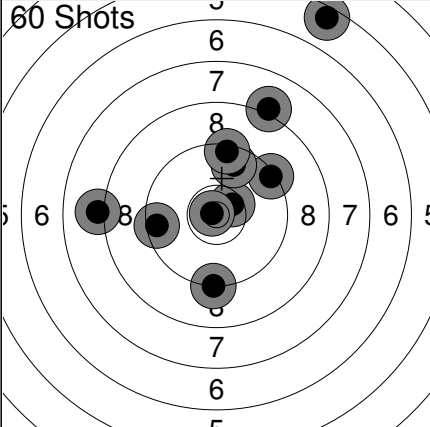
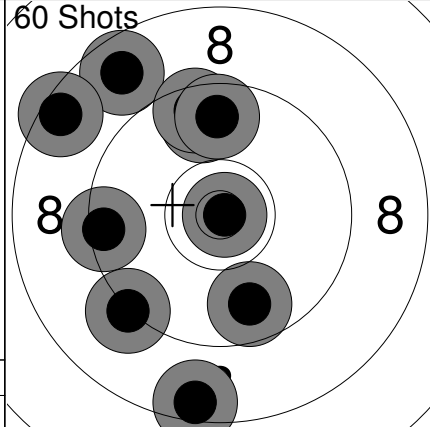
<p>Sight</p> 	<p>1: 9.3 ↖ 2: 8.7 → 3: 9.6 ↗ 4: 10.2 ← 5: 9.5 ↓ 6: 7.6 ↙ 7: 9.5 ↗ 8: 9.2 ← 9: 10.6x → 10: 8.8 ↓</p> <p>Series 88 (1x) 0 (0x)</p>	<p>Sight</p> 	<p>11: 9.6 ↓ 12: 10.5x ↙</p> <p>Series 19 (1x) 0 (0x)</p>
<p>60 Shots</p> 	<p>1: 8.9 → 2: 9.6 ↓ 3: 9.5 ← 4: 8.9 ↘ 5: 9.8 ↓ 6: 10.0 ↗ 7: 7.1 ↑ 8: 9.1 ↗ 9: 10.5x ↘ 10: 7.5 →</p> <p>Series 86 (1x) 86 (1x)</p>	<p>60 Shots</p> 	<p>11: 10.1 ↗ 12: 10.7x ↗ 13: 6.0 ↑ 14: 10.0 ↓ 15: 8.8 ↗ 16: 9.0 ↗ 17: 10.2 ↗ 18: 9.3 ↙ 19: 7.6 ↑ 20: 10.1 ↓</p> <p>Series 89 (1x) 175 (2x)</p>
<p>60 Shots</p> 	<p>21: 7.6 ↓ 22: 9.0 ↓ 23: 6.9 ↑ 24: 10.7x → 25: 8.5 ↓ 26: 10.2 ↓ 27: 8.8 ↗ 28: 7.1 ↑ 29: 9.2 ↗ 30: 7.6 ↗</p> <p>Series 81 (1x) 256 (3x)</p>	<p>60 Shots</p> 	<p>31: 9.0 → 32: 7.6 ↗ 33: 9.2 → 34: 8.3 ↑ 35: 9.5 → 36: 8.4 ↗ 37: 7.2 ↑ 38: 10.3 ↗ 39: 8.3 ↗ 40: 9.8 ←</p> <p>Series 84 (0x) 340 (3x)</p>
<p>60 Shots</p> 	<p>41: 10.5x ↗ 42: 8.1 ← 43: 9.2 ↓ 44: 9.5 ← 45: 10.8x ← 46: 8.1 ↗ 47: 9.3 ↗ 48: 9.7 ↗ 49: 5.5 ↗ 50: 9.4 ↑</p> <p>Series 86 (2x) 426 (5x)</p>	<p>60 Shots</p> 	<p>51: 9.7 ↑ 52: 9.4 ← 53: 8.7 ↗ 54: 10.9x → 55: 9.6 ↑ 56: 8.5 ↖ 57: 8.5 ↓ 58: 9.7 ↑ 59: 9.2 ↙ 60: 9.7 ↓</p> <p>Series 88 (1x) 514 (6x)</p>

Relay <b>2</b>	Lane <b>5</b>	<b>ZHAO Angela</b>
-------------------	------------------	--------------------

2023 Western Cdn Air Gur BC	JR	WP
-----------------------------	----	----

14.10.2023	2023 WCAGC Qualifier	Alberta Handgun Association
------------	----------------------	-----------------------------

Comment	Signature
---------	-----------

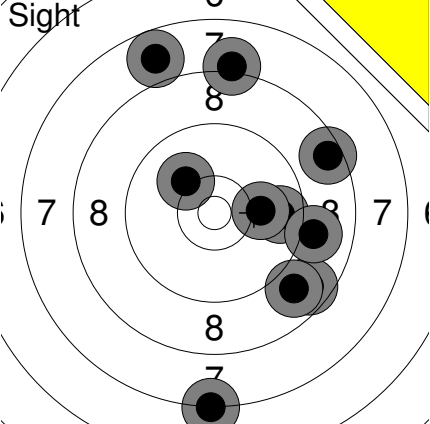
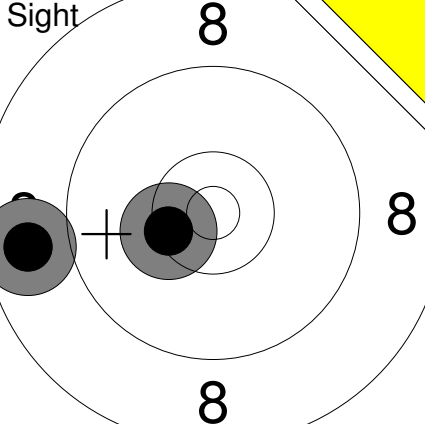
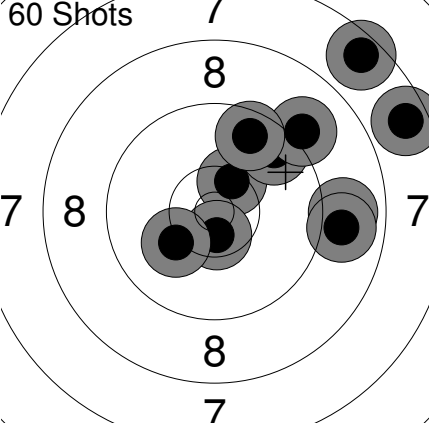
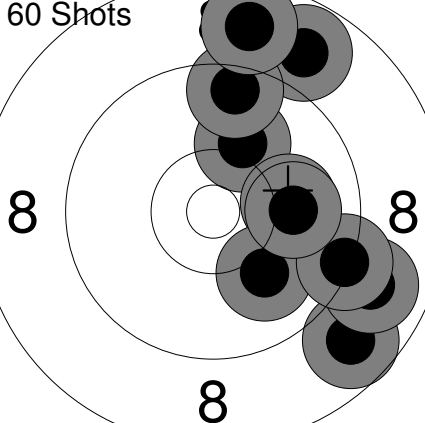
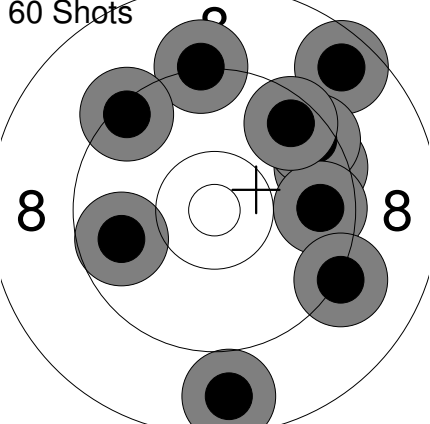
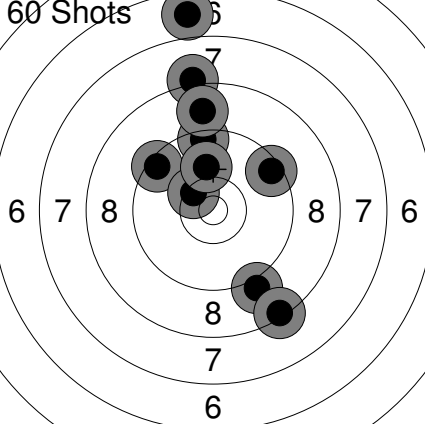
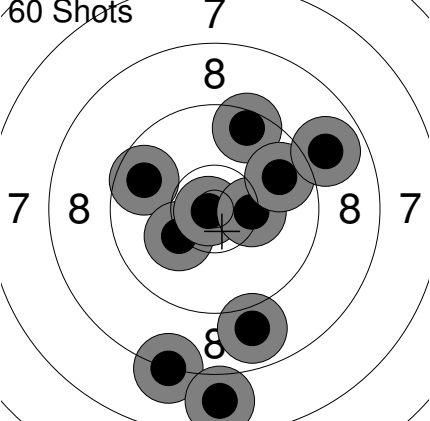
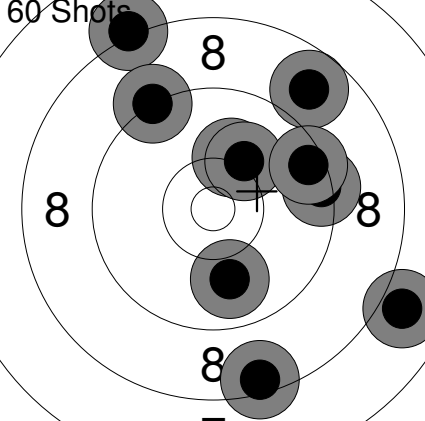
	<p>1: 9.7 →</p> <p>2: 10.1 ↗</p> <p>3: 8.5 →</p> <p>4: 8.1 ↑</p> <p>5: 10.1 →</p> <p>6: 8.7 ↘</p> <p>7: 7.2 ↓</p> <p>8: 7.8 ↑</p> <p>9: 9.0 →</p> <p>10: 8.8 ↓</p>		<p>11: 10.4x ←</p> <p>12: 8.7 ←</p>
	<p>1: 7.5 ↗</p> <p>2: 10.4x ↗</p> <p>3: 9.6 ↗</p> <p>4: 7.6 →</p> <p>5: 10.6x ↓</p> <p>6: 9.1 ↗</p> <p>7: 9.6 ↑</p> <p>8: 8.9 →</p> <p>9: 8.9 →</p> <p>10: 10.2 ↘</p>		<p>11: 8.8 ↗</p> <p>12: 10.1 ↗</p> <p>13: 10.1 →</p> <p>14: 8.8 ↘</p> <p>15: 9.5 ↑</p> <p>16: 8.8 ↑</p> <p>17: 10.0 ↓</p> <p>18: 8.9 ↘</p> <p>19: 9.3 ↘</p> <p>20: 10.0 →</p>
	<p>21: 9.6 →</p> <p>22: 9.8 ←</p> <p>23: 8.6 ↗</p> <p>24: 9.5 ↗</p> <p>25: 9.7 →</p> <p>26: 9.2 ↑</p> <p>27: 9.5 ↗</p> <p>28: 8.7 ↓</p> <p>29: 9.4 ↗</p> <p>30: 9.2 →</p>		<p>31: 6.7 ↑</p> <p>32: 9.4 ↗</p> <p>33: 9.4 ↑</p> <p>34: 10.4x ↗</p> <p>35: 8.1 ↑</p> <p>36: 9.4 ↗</p> <p>37: 9.0 ↓</p> <p>38: 8.8 ↑</p> <p>39: 10.0 ↑</p> <p>40: 8.3 ↓</p>
	<p>41: 9.5 ↗</p> <p>42: 9.7 ←</p> <p>43: 10.2 ←</p> <p>44: 10.8x ←</p> <p>45: 10.3 →</p> <p>46: 8.2 ↓</p> <p>47: 7.8 ↓</p> <p>48: 9.8 →</p> <p>49: 8.9 ↓</p> <p>50: 8.9 →</p>		<p>51: 8.2 ↗</p> <p>52: 9.4 →</p> <p>53: 8.8 ↗</p> <p>54: 8.4 ↓</p> <p>55: 7.9 ↘</p> <p>56: 9.2 ↗</p> <p>57: 10.2 ↑</p> <p>58: 10.1 ↗</p> <p>59: 9.9 ↓</p> <p>60: 9.5 →</p>

<p>Sight</p>	<p>1: 8.4 ↑ 2: 9.3 ↓ 3: 8.4 ↓ 4: 9.1 ↓ 5: 8.7 ← 6: 8.8 ↓ 7: 8.3 ↓ 8: 6.6 ← 9: 8.7 ↓ 10: 8.5 ←</p> <p>Series 80 (0x) 0 (0x)</p>	<p>Sight</p>	<p>11: 7.8 ↑ 12: 7.9 ↑ 13: 7.3 ↓</p> <p>Series 21 (0x) 0 (0x)</p>
<p>60 Shots</p>	<p>1: 5.9 ← 2: 10.1 ↓ 3: 8.2 ↓ 4: 9.0 ← 5: 7.9 → 6: 7.4 ← 7: 8.2 ↓ 8: 10.5x ↑ 9: 7.7 → 10: 9.9 ←</p> <p>Series 80 (1x) 80 (1x)</p>	<p>60 Shots</p>	<p>11: 10.4x ← 12: 9.1 ↖ 13: 10.2 ↓ 14: 10.4x ↓ 15: 7.1 → 16: 7.6 ← 17: 6.9 ↓ 18: 8.8 ↖ 19: 9.4 ↑ 20: 9.6 ↑</p> <p>Series 85 (2x) 165 (3x)</p>
<p>60 Shots</p>	<p>21: 9.0 ↑ 22: 8.2 ↓ 23: 10.3 ↓ 24: 4.4 ↓ 25: 9.2 ↓ 26: 9.1 ← 27: 9.2 ↓ 28: 9.6 ↓ 29: 8.7 ↑ 30: 6.9 ↓</p> <p>Series 81 (0x) 246 (3x)</p>	<p>60 Shots</p>	<p>31: 10.1 ↖ 32: 10.4 ↑ 33: 8.8 ↑ 34: 5.0 ↓ 35: 10.4x ↖ 36: 8.8 ↑ 37: 7.7 ↓ 38: 5.7 ↓ 39: 10.2 → 40: 5.9 →</p> <p>Series 78 (1x) 324 (4x)</p>
<p>60 Shots</p>	<p>41: 6.0 ↓ 42: 6.9 ← 43: 5.7 ↓ 44: 7.5 ↑ 45: 8.7 ↓ 46: 9.9 ↓ 47: 5.9 → 48: 7.7 → 49: 3.1 ↓ 50: 7.4 ↓</p> <p>Series 63 (0x) 387 (4x)</p>	<p>60 Shots</p>	<p>51: 8.4 ↖ 52: 6.3 ↓ 53: 9.9 ↑ 54: 6.5 → 55: 1.4 ↓ 56: 6.0 → 57: 8.3 ↓ 58: 9.9 ↓ 59: 6.2 → 60: 7.7 ↓</p> <p>Series 66 (0x) 453 (4x)</p>

Relay **2** Lane **8** **PATNAIK Adheesh**

2023 Western Cdn Air Gur AB JR MR

14.10.2023 2023 WCAGC Qualifier Alberta Handgun Association

Comment Signature

	1: 9.5 ←		11: 10.1 →
	2: 9.7 ↗		12: 7.6 ↖
	3: 9.0 ↖		13: 9.8 ↗
	4: 7.7 ↖		14: 10.0 ←
	5: 8.2 ←		15: 10.5x →
	6: 9.7 ↗		16: 10.4x →
	7: 7.9 ↘		17: 9.3 ←
	8: 8.9 ↗		18: 9.5 ←
	9: 8.5 →		19: 8.6 ↑
	10: 9.2 ←		20: 10.0 ←
Series	88.3	Series	95.8
	0.0		0.0

	1: 9.6 ↓		11: 9.7 ←
	2: 9.6 ←		12: 8.6 →
	3: 9.6 ↑		13: 9.1 ↗
	4: 10.3x ↗		14: 9.5 ↑
	5: 9.1 →		15: 9.5 ←
	6: 10.3x ↓		16: 10.5x →
	7: 9.3 ←		17: 9.2 →
	8: 10.6x ↗		18: 8.3 →
	9: 10.5x →		19: 10.1 ←
	10: 7.8 ←		20: 8.5 ↗
Series	96.7	Series	93.0
	96.7		189.7

	21: 10.1 ↑		31: 9.7 ↓
	22: 10.1 ↑		32: 9.1 ↓
	23: 9.6 ←		33: 9.9 →
	24: 8.8 ↓		34: 10.2x →
	25: 9.6 ↗		35: 10.1 ↖
	26: 10.5x ←		36: 10.6x ↗
	27: 9.0 ↖		37: 9.0 →
	28: 9.6 ↗		38: 10.3x ↑
	29: 10.4x ↖		39: 9.8 ↗
	30: 9.1 ↗		40: 8.9 →
Series	96.8	Series	97.6
	286.5		384.1

	41: 10.8x →		51: 9.2 →
	42: 9.2 →		52: 10.6x ←
	43: 9.0 ←		53: 9.8 →
	44: 10.2x →		54: 9.0 ↗
	45: 9.6 ↓		55: 9.2 ←
	46: 9.8 ↗		56: 10.0 →
	47: 10.6x ↖		57: 10.3x ←
	48: 10.4x ↗		58: 10.6x ↗
	49: 9.5 ←		59: 9.3 ←
	50: 9.9 ↗		60: 9.5 ↓
Series	99.0	Series	97.5
	483.1		580.6

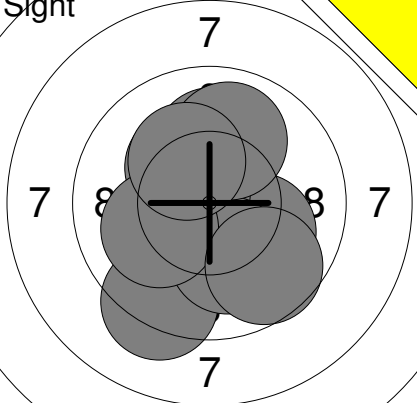
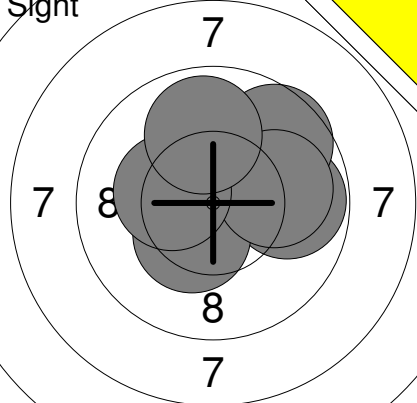
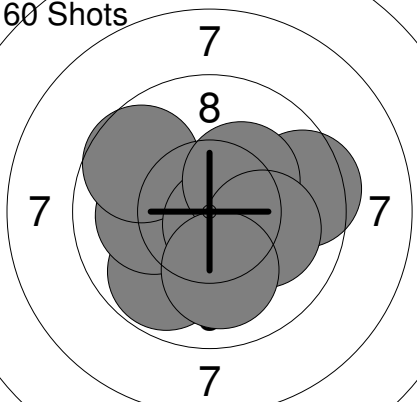
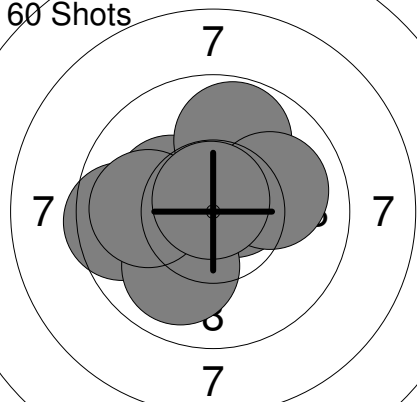
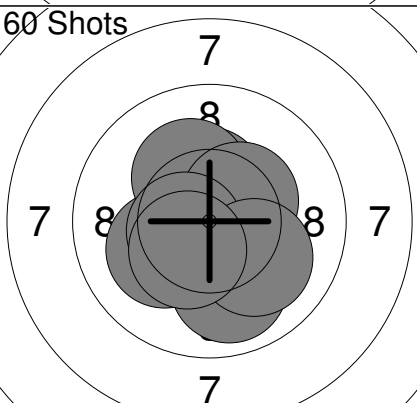
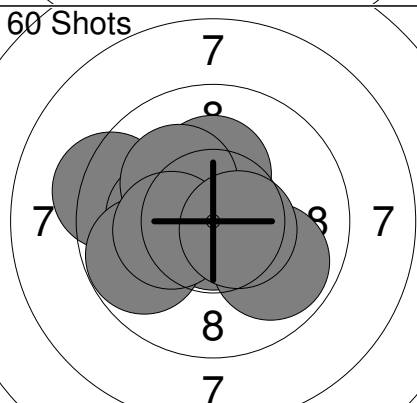
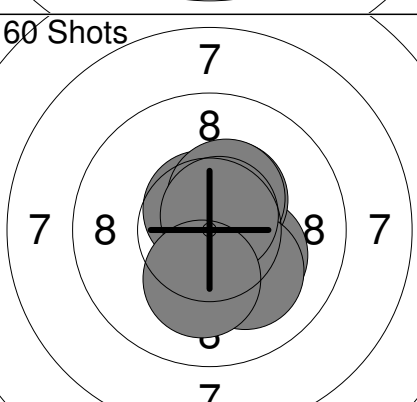
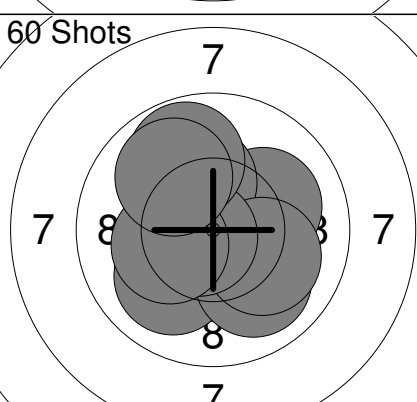
<b>Sight</b> 	<table style="width:100%; border-collapse: collapse;"> <tr><td>1:</td><td>9.3</td><td>↘</td></tr> <tr><td>2:</td><td>10.1</td><td>↘</td></tr> <tr><td>3:</td><td>10.1</td><td>↑</td></tr> <tr><td>4:</td><td>10.6x</td><td>↖</td></tr> <tr><td>5:</td><td>10.3x</td><td>↗</td></tr> <tr><td>6:</td><td>10.1</td><td>↘</td></tr> <tr><td>7:</td><td>10.1</td><td>↖</td></tr> <tr><td>8:</td><td>10.0</td><td>↑</td></tr> <tr><td>9:</td><td>10.2x</td><td>↗</td></tr> <tr><td>10:</td><td>9.7</td><td>↘</td></tr> <tr><td colspan="2">Series</td><td>100.5</td></tr> <tr><td colspan="2"></td><td>0.0</td></tr> </table>	1:	9.3	↘	2:	10.1	↘	3:	10.1	↑	4:	10.6x	↖	5:	10.3x	↗	6:	10.1	↘	7:	10.1	↖	8:	10.0	↑	9:	10.2x	↗	10:	9.7	↘	Series		100.5			0.0	<b>Sight</b> 	<table style="width:100%; border-collapse: collapse;"> <tr><td>11:</td><td>9.8</td><td>→</td></tr> <tr><td>12:</td><td>10.4x</td><td>↘</td></tr> <tr><td>13:</td><td>9.6</td><td>↗</td></tr> <tr><td>14:</td><td>10.0</td><td>→</td></tr> <tr><td>15:</td><td>10.3x</td><td>↖</td></tr> <tr><td>16:</td><td>9.9</td><td>↑</td></tr> <tr><td colspan="2">Series</td><td>60.0</td></tr> <tr><td colspan="2"></td><td>0.0</td></tr> </table>	11:	9.8	→	12:	10.4x	↘	13:	9.6	↗	14:	10.0	→	15:	10.3x	↖	16:	9.9	↑	Series		60.0			0.0												
1:	9.3	↘																																																																									
2:	10.1	↘																																																																									
3:	10.1	↑																																																																									
4:	10.6x	↖																																																																									
5:	10.3x	↗																																																																									
6:	10.1	↘																																																																									
7:	10.1	↖																																																																									
8:	10.0	↑																																																																									
9:	10.2x	↗																																																																									
10:	9.7	↘																																																																									
Series		100.5																																																																									
		0.0																																																																									
11:	9.8	→																																																																									
12:	10.4x	↘																																																																									
13:	9.6	↗																																																																									
14:	10.0	→																																																																									
15:	10.3x	↖																																																																									
16:	9.9	↑																																																																									
Series		60.0																																																																									
		0.0																																																																									
<b>60 Shots</b> 	<table style="width:100%; border-collapse: collapse;"> <tr><td>1:</td><td>9.8</td><td>↘</td></tr> <tr><td>2:</td><td>10.8x</td><td>↘</td></tr> <tr><td>3:</td><td>10.5x</td><td>→</td></tr> <tr><td>4:</td><td>9.5</td><td>→</td></tr> <tr><td>5:</td><td>10.1</td><td>↖</td></tr> <tr><td>6:</td><td>9.7</td><td>↗</td></tr> <tr><td>7:</td><td>10.7x</td><td>↘</td></tr> <tr><td>8:</td><td>10.3x</td><td>↗</td></tr> <tr><td>9:</td><td>10.1</td><td>→</td></tr> <tr><td>10:</td><td>10.0</td><td>↘</td></tr> <tr><td colspan="2">Series</td><td>101.5</td></tr> <tr><td colspan="2"></td><td>101.5</td></tr> </table>	1:	9.8	↘	2:	10.8x	↘	3:	10.5x	→	4:	9.5	→	5:	10.1	↖	6:	9.7	↗	7:	10.7x	↘	8:	10.3x	↗	9:	10.1	→	10:	10.0	↘	Series		101.5			101.5	<b>60 Shots</b> 	<table style="width:100%; border-collapse: collapse;"> <tr><td>11:</td><td>9.5</td><td>←</td></tr> <tr><td>12:</td><td>10.6x</td><td>↗</td></tr> <tr><td>13:</td><td>10.4x</td><td>↖</td></tr> <tr><td>14:</td><td>10.7x</td><td>↑</td></tr> <tr><td>15:</td><td>10.3x</td><td>↖</td></tr> <tr><td>16:</td><td>10.0</td><td>↘</td></tr> <tr><td>17:</td><td>9.9</td><td>←</td></tr> <tr><td>18:</td><td>9.8</td><td>↑</td></tr> <tr><td>19:</td><td>10.0</td><td>→</td></tr> <tr><td>20:</td><td>10.8x</td><td>↑</td></tr> <tr><td colspan="2">Series</td><td>102.0</td></tr> <tr><td colspan="2"></td><td>203.5</td></tr> </table>	11:	9.5	←	12:	10.6x	↗	13:	10.4x	↖	14:	10.7x	↑	15:	10.3x	↖	16:	10.0	↘	17:	9.9	←	18:	9.8	↑	19:	10.0	→	20:	10.8x	↑	Series		102.0			203.5
1:	9.8	↘																																																																									
2:	10.8x	↘																																																																									
3:	10.5x	→																																																																									
4:	9.5	→																																																																									
5:	10.1	↖																																																																									
6:	9.7	↗																																																																									
7:	10.7x	↘																																																																									
8:	10.3x	↗																																																																									
9:	10.1	→																																																																									
10:	10.0	↘																																																																									
Series		101.5																																																																									
		101.5																																																																									
11:	9.5	←																																																																									
12:	10.6x	↗																																																																									
13:	10.4x	↖																																																																									
14:	10.7x	↑																																																																									
15:	10.3x	↖																																																																									
16:	10.0	↘																																																																									
17:	9.9	←																																																																									
18:	9.8	↑																																																																									
19:	10.0	→																																																																									
20:	10.8x	↑																																																																									
Series		102.0																																																																									
		203.5																																																																									
<b>60 Shots</b> 	<table style="width:100%; border-collapse: collapse;"> <tr><td>21:</td><td>10.1</td><td>↖</td></tr> <tr><td>22:</td><td>10.4x</td><td>↑</td></tr> <tr><td>23:</td><td>10.2x</td><td>↗</td></tr> <tr><td>24:</td><td>10.7x</td><td>↘</td></tr> <tr><td>25:</td><td>10.7x</td><td>↘</td></tr> <tr><td>26:</td><td>9.9</td><td>↘</td></tr> <tr><td>27:</td><td>10.4x</td><td>↗</td></tr> <tr><td>28:</td><td>10.5x</td><td>↖</td></tr> <tr><td>29:</td><td>10.1</td><td>↘</td></tr> <tr><td>30:</td><td>10.4x</td><td>↘</td></tr> <tr><td colspan="2">Series</td><td>103.4</td></tr> <tr><td colspan="2"></td><td>306.9</td></tr> </table>	21:	10.1	↖	22:	10.4x	↑	23:	10.2x	↗	24:	10.7x	↘	25:	10.7x	↘	26:	9.9	↘	27:	10.4x	↗	28:	10.5x	↖	29:	10.1	↘	30:	10.4x	↘	Series		103.4			306.9	<b>60 Shots</b> 	<table style="width:100%; border-collapse: collapse;"> <tr><td>31:</td><td>9.3</td><td>←</td></tr> <tr><td>32:</td><td>10.8x</td><td>↘</td></tr> <tr><td>33:</td><td>10.4x</td><td>←</td></tr> <tr><td>34:</td><td>10.2x</td><td>←</td></tr> <tr><td>35:</td><td>10.2x</td><td>↑</td></tr> <tr><td>36:</td><td>9.9</td><td>↘</td></tr> <tr><td>37:</td><td>9.8</td><td>↖</td></tr> <tr><td>38:</td><td>10.2x</td><td>↗</td></tr> <tr><td>39:</td><td>10.3x</td><td>←</td></tr> <tr><td>40:</td><td>10.6x</td><td>→</td></tr> <tr><td colspan="2">Series</td><td>101.7</td></tr> <tr><td colspan="2"></td><td>408.6</td></tr> </table>	31:	9.3	←	32:	10.8x	↘	33:	10.4x	←	34:	10.2x	←	35:	10.2x	↑	36:	9.9	↘	37:	9.8	↖	38:	10.2x	↗	39:	10.3x	←	40:	10.6x	→	Series		101.7			408.6
21:	10.1	↖																																																																									
22:	10.4x	↑																																																																									
23:	10.2x	↗																																																																									
24:	10.7x	↘																																																																									
25:	10.7x	↘																																																																									
26:	9.9	↘																																																																									
27:	10.4x	↗																																																																									
28:	10.5x	↖																																																																									
29:	10.1	↘																																																																									
30:	10.4x	↘																																																																									
Series		103.4																																																																									
		306.9																																																																									
31:	9.3	←																																																																									
32:	10.8x	↘																																																																									
33:	10.4x	←																																																																									
34:	10.2x	←																																																																									
35:	10.2x	↑																																																																									
36:	9.9	↘																																																																									
37:	9.8	↖																																																																									
38:	10.2x	↗																																																																									
39:	10.3x	←																																																																									
40:	10.6x	→																																																																									
Series		101.7																																																																									
		408.6																																																																									
<b>60 Shots</b> 	<table style="width:100%; border-collapse: collapse;"> <tr><td>41:</td><td>10.2x</td><td>→</td></tr> <tr><td>42:</td><td>10.4x</td><td>↗</td></tr> <tr><td>43:</td><td>10.6x</td><td>↗</td></tr> <tr><td>44:</td><td>10.7x</td><td>↗</td></tr> <tr><td>45:</td><td>10.4x</td><td>↗</td></tr> <tr><td>46:</td><td>10.3x</td><td>↘</td></tr> <tr><td>47:</td><td>10.3x</td><td>↘</td></tr> <tr><td>48:</td><td>10.1</td><td>↘</td></tr> <tr><td>49:</td><td>10.7x</td><td>↗</td></tr> <tr><td>50:</td><td>10.2x</td><td>↘</td></tr> <tr><td colspan="2">Series</td><td>103.9</td></tr> <tr><td colspan="2"></td><td>512.5</td></tr> </table>	41:	10.2x	→	42:	10.4x	↗	43:	10.6x	↗	44:	10.7x	↗	45:	10.4x	↗	46:	10.3x	↘	47:	10.3x	↘	48:	10.1	↘	49:	10.7x	↗	50:	10.2x	↘	Series		103.9			512.5	<b>60 Shots</b> 	<table style="width:100%; border-collapse: collapse;"> <tr><td>51:</td><td>10.7x</td><td>↘</td></tr> <tr><td>52:</td><td>10.1</td><td>↗</td></tr> <tr><td>53:</td><td>10.0</td><td>↘</td></tr> <tr><td>54:</td><td>10.2x</td><td>↗</td></tr> <tr><td>55:</td><td>10.0</td><td>↘</td></tr> <tr><td>56:</td><td>10.1</td><td>→</td></tr> <tr><td>57:</td><td>10.7x</td><td>↖</td></tr> <tr><td>58:</td><td>9.8</td><td>↗</td></tr> <tr><td>59:</td><td>10.3x</td><td>←</td></tr> <tr><td>60:</td><td>9.9</td><td>↗</td></tr> <tr><td colspan="2">Series</td><td>101.8</td></tr> <tr><td colspan="2"></td><td>614.3</td></tr> </table>	51:	10.7x	↘	52:	10.1	↗	53:	10.0	↘	54:	10.2x	↗	55:	10.0	↘	56:	10.1	→	57:	10.7x	↖	58:	9.8	↗	59:	10.3x	←	60:	9.9	↗	Series		101.8			614.3
41:	10.2x	→																																																																									
42:	10.4x	↗																																																																									
43:	10.6x	↗																																																																									
44:	10.7x	↗																																																																									
45:	10.4x	↗																																																																									
46:	10.3x	↘																																																																									
47:	10.3x	↘																																																																									
48:	10.1	↘																																																																									
49:	10.7x	↗																																																																									
50:	10.2x	↘																																																																									
Series		103.9																																																																									
		512.5																																																																									
51:	10.7x	↘																																																																									
52:	10.1	↗																																																																									
53:	10.0	↘																																																																									
54:	10.2x	↗																																																																									
55:	10.0	↘																																																																									
56:	10.1	→																																																																									
57:	10.7x	↖																																																																									
58:	9.8	↗																																																																									
59:	10.3x	←																																																																									
60:	9.9	↗																																																																									
Series		101.8																																																																									
		614.3																																																																									

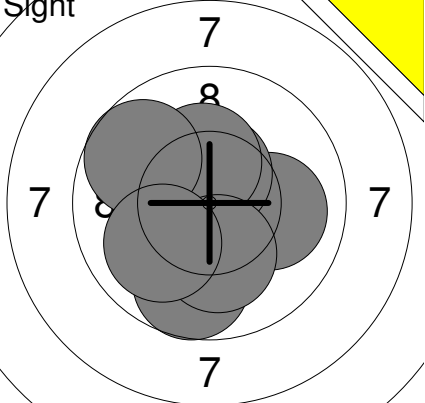
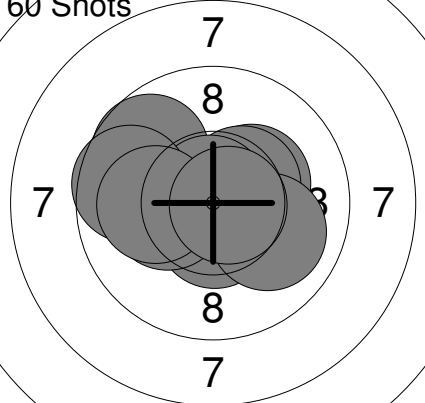
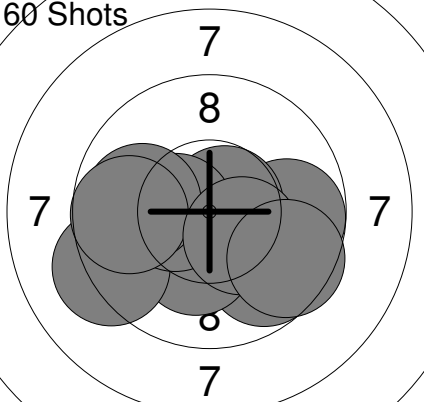
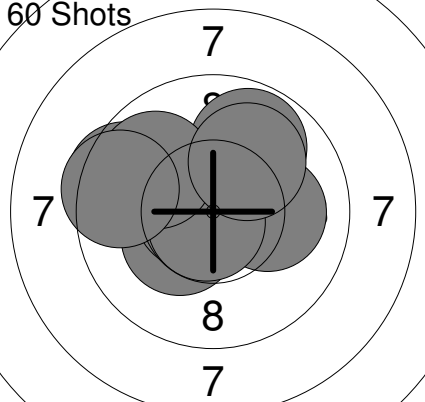
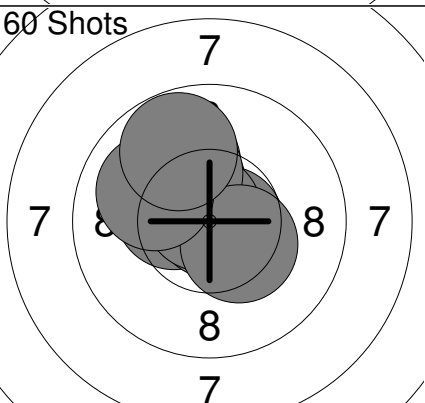
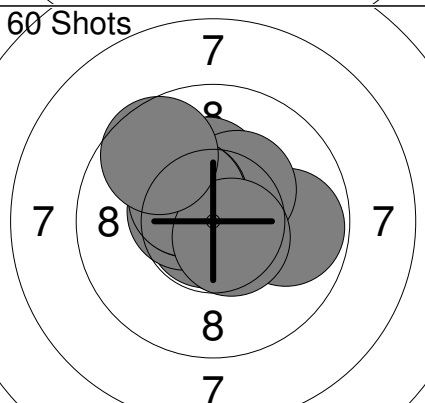
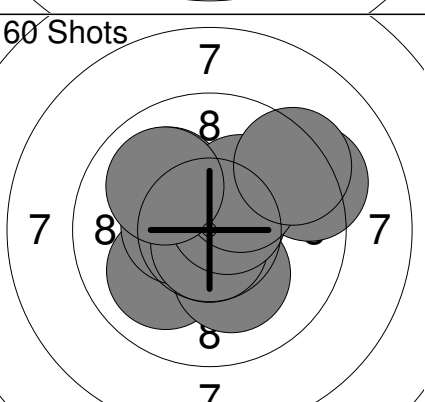
<p>Sight</p> 	<table border="1" style="width:100%; border-collapse: collapse;"> <tr><td>1:</td><td>10.0</td><td>→</td></tr> <tr><td>2:</td><td>10.5x</td><td>↑</td></tr> <tr><td>3:</td><td>9.7</td><td>↓</td></tr> <tr><td>4:</td><td>10.5x</td><td>←</td></tr> <tr><td>5:</td><td>10.3x</td><td>↑</td></tr> <tr><td>6:</td><td>10.2x</td><td>↓</td></tr> <tr><td>7:</td><td>9.7</td><td>↗</td></tr> <tr><td>8:</td><td>10.0</td><td>↖</td></tr> <tr><td colspan="2">Series</td><td>80.9</td></tr> <tr><td colspan="2"></td><td>0.0</td></tr> </table>	1:	10.0	→	2:	10.5x	↑	3:	9.7	↓	4:	10.5x	←	5:	10.3x	↑	6:	10.2x	↓	7:	9.7	↗	8:	10.0	↖	Series		80.9			0.0	<p>60 Shots</p>  <table border="1" style="width:100%; border-collapse: collapse;"> <tr><td>1:</td><td>10.5x</td><td>↓</td></tr> <tr><td>2:</td><td>10.2x</td><td>←</td></tr> <tr><td>3:</td><td>10.3x</td><td>→</td></tr> <tr><td>4:</td><td>10.4x</td><td>↗</td></tr> <tr><td>5:</td><td>10.0</td><td>→</td></tr> <tr><td>6:</td><td>9.7</td><td>↗</td></tr> <tr><td>7:</td><td>10.8x</td><td>↑</td></tr> <tr><td>8:</td><td>9.7</td><td>←</td></tr> <tr><td>9:</td><td>10.1</td><td>←</td></tr> <tr><td>10:</td><td>10.7x</td><td>→</td></tr> <tr><td colspan="2">Series</td><td>102.4</td></tr> <tr><td colspan="2"></td><td>102.4</td></tr> </table>	1:	10.5x	↓	2:	10.2x	←	3:	10.3x	→	4:	10.4x	↗	5:	10.0	→	6:	9.7	↗	7:	10.8x	↑	8:	9.7	←	9:	10.1	←	10:	10.7x	→	Series		102.4			102.4							
1:	10.0	→																																																																									
2:	10.5x	↑																																																																									
3:	9.7	↓																																																																									
4:	10.5x	←																																																																									
5:	10.3x	↑																																																																									
6:	10.2x	↓																																																																									
7:	9.7	↗																																																																									
8:	10.0	↖																																																																									
Series		80.9																																																																									
		0.0																																																																									
1:	10.5x	↓																																																																									
2:	10.2x	←																																																																									
3:	10.3x	→																																																																									
4:	10.4x	↗																																																																									
5:	10.0	→																																																																									
6:	9.7	↗																																																																									
7:	10.8x	↑																																																																									
8:	9.7	←																																																																									
9:	10.1	←																																																																									
10:	10.7x	→																																																																									
Series		102.4																																																																									
		102.4																																																																									
<p>60 Shots</p> 	<table border="1" style="width:100%; border-collapse: collapse;"> <tr><td>11:</td><td>9.8</td><td>↘</td></tr> <tr><td>12:</td><td>9.8</td><td>→</td></tr> <tr><td>13:</td><td>10.2x</td><td>↓</td></tr> <tr><td>14:</td><td>10.7x</td><td>→</td></tr> <tr><td>15:</td><td>9.2</td><td>←</td></tr> <tr><td>16:</td><td>10.4x</td><td>←</td></tr> <tr><td>17:</td><td>9.9</td><td>←</td></tr> <tr><td>18:</td><td>9.7</td><td>←</td></tr> <tr><td>19:</td><td>10.3x</td><td>↘</td></tr> <tr><td>20:</td><td>9.6</td><td>↘</td></tr> <tr><td colspan="2">Series</td><td>99.6</td></tr> <tr><td colspan="2"></td><td>202.0</td></tr> </table>	11:	9.8	↘	12:	9.8	→	13:	10.2x	↓	14:	10.7x	→	15:	9.2	←	16:	10.4x	←	17:	9.9	←	18:	9.7	←	19:	10.3x	↘	20:	9.6	↘	Series		99.6			202.0	<p>60 Shots</p>  <table border="1" style="width:100%; border-collapse: collapse;"> <tr><td>21:</td><td>9.5</td><td>←</td></tr> <tr><td>22:</td><td>10.3x</td><td>↖</td></tr> <tr><td>23:</td><td>10.1</td><td>→</td></tr> <tr><td>24:</td><td>9.8</td><td>↗</td></tr> <tr><td>25:</td><td>10.5x</td><td>↖</td></tr> <tr><td>26:</td><td>10.6x</td><td>←</td></tr> <tr><td>27:</td><td>10.8x</td><td>↓</td></tr> <tr><td>28:</td><td>9.9</td><td>↖</td></tr> <tr><td>29:</td><td>10.0</td><td>↗</td></tr> <tr><td>30:</td><td>9.5</td><td>←</td></tr> <tr><td colspan="2">Series</td><td>101.0</td></tr> <tr><td colspan="2"></td><td>303.0</td></tr> </table>	21:	9.5	←	22:	10.3x	↖	23:	10.1	→	24:	9.8	↗	25:	10.5x	↖	26:	10.6x	←	27:	10.8x	↓	28:	9.9	↖	29:	10.0	↗	30:	9.5	←	Series		101.0			303.0	
11:	9.8	↘																																																																									
12:	9.8	→																																																																									
13:	10.2x	↓																																																																									
14:	10.7x	→																																																																									
15:	9.2	←																																																																									
16:	10.4x	←																																																																									
17:	9.9	←																																																																									
18:	9.7	←																																																																									
19:	10.3x	↘																																																																									
20:	9.6	↘																																																																									
Series		99.6																																																																									
		202.0																																																																									
21:	9.5	←																																																																									
22:	10.3x	↖																																																																									
23:	10.1	→																																																																									
24:	9.8	↗																																																																									
25:	10.5x	↖																																																																									
26:	10.6x	←																																																																									
27:	10.8x	↓																																																																									
28:	9.9	↖																																																																									
29:	10.0	↗																																																																									
30:	9.5	←																																																																									
Series		101.0																																																																									
		303.0																																																																									
<p>60 Shots</p> 	<table border="1" style="width:100%; border-collapse: collapse;"> <tr><td>31:</td><td>10.4x</td><td>←</td></tr> <tr><td>32:</td><td>10.9x</td><td>→</td></tr> <tr><td>33:</td><td>10.7x</td><td>→</td></tr> <tr><td>34:</td><td>10.3x</td><td>↗</td></tr> <tr><td>35:</td><td>10.0</td><td>↗</td></tr> <tr><td>36:</td><td>10.8x</td><td>↗</td></tr> <tr><td>37:</td><td>10.1</td><td>↗</td></tr> <tr><td>38:</td><td>10.4x</td><td>↘</td></tr> <tr><td>39:</td><td>10.0</td><td>↗</td></tr> <tr><td>40:</td><td>9.8</td><td>↗</td></tr> <tr><td colspan="2">Series</td><td>103.4</td></tr> <tr><td colspan="2"></td><td>406.4</td></tr> </table>	31:	10.4x	←	32:	10.9x	→	33:	10.7x	→	34:	10.3x	↗	35:	10.0	↗	36:	10.8x	↗	37:	10.1	↗	38:	10.4x	↘	39:	10.0	↗	40:	9.8	↗	Series		103.4			406.4	<p>60 Shots</p>  <table border="1" style="width:100%; border-collapse: collapse;"> <tr><td>41:</td><td>10.3x</td><td>↑</td></tr> <tr><td>42:</td><td>10.7x</td><td>↓</td></tr> <tr><td>43:</td><td>9.8</td><td>→</td></tr> <tr><td>44:</td><td>10.8x</td><td>↖</td></tr> <tr><td>45:</td><td>10.3x</td><td>↗</td></tr> <tr><td>46:</td><td>10.5x</td><td>↖</td></tr> <tr><td>47:</td><td>10.4x</td><td>↗</td></tr> <tr><td>48:</td><td>10.4x</td><td>↗</td></tr> <tr><td>49:</td><td>10.6x</td><td>↓</td></tr> <tr><td>50:</td><td>9.7</td><td>↗</td></tr> <tr><td colspan="2">Series</td><td>103.5</td></tr> <tr><td colspan="2"></td><td>509.9</td></tr> </table>	41:	10.3x	↑	42:	10.7x	↓	43:	9.8	→	44:	10.8x	↖	45:	10.3x	↗	46:	10.5x	↖	47:	10.4x	↗	48:	10.4x	↗	49:	10.6x	↓	50:	9.7	↗	Series		103.5			509.9	
31:	10.4x	←																																																																									
32:	10.9x	→																																																																									
33:	10.7x	→																																																																									
34:	10.3x	↗																																																																									
35:	10.0	↗																																																																									
36:	10.8x	↗																																																																									
37:	10.1	↗																																																																									
38:	10.4x	↘																																																																									
39:	10.0	↗																																																																									
40:	9.8	↗																																																																									
Series		103.4																																																																									
		406.4																																																																									
41:	10.3x	↑																																																																									
42:	10.7x	↓																																																																									
43:	9.8	→																																																																									
44:	10.8x	↖																																																																									
45:	10.3x	↗																																																																									
46:	10.5x	↖																																																																									
47:	10.4x	↗																																																																									
48:	10.4x	↗																																																																									
49:	10.6x	↓																																																																									
50:	9.7	↗																																																																									
Series		103.5																																																																									
		509.9																																																																									
<p>60 Shots</p> 	<table border="1" style="width:100%; border-collapse: collapse;"> <tr><td>51:</td><td>10.0</td><td>↖</td></tr> <tr><td>52:</td><td>10.5x</td><td>←</td></tr> <tr><td>53:</td><td>10.0</td><td>↗</td></tr> <tr><td>54:</td><td>9.3</td><td>→</td></tr> <tr><td>55:</td><td>10.2x</td><td>↓</td></tr> <tr><td>56:</td><td>10.7x</td><td>↓</td></tr> <tr><td>57:</td><td>10.6x</td><td>↗</td></tr> <tr><td>58:</td><td>10.2x</td><td>↗</td></tr> <tr><td>59:</td><td>10.0</td><td>↗</td></tr> <tr><td>60:</td><td>9.4</td><td>↗</td></tr> <tr><td colspan="2">Series</td><td>100.9</td></tr> <tr><td colspan="2"></td><td>610.8</td></tr> </table>	51:	10.0	↖	52:	10.5x	←	53:	10.0	↗	54:	9.3	→	55:	10.2x	↓	56:	10.7x	↓	57:	10.6x	↗	58:	10.2x	↗	59:	10.0	↗	60:	9.4	↗	Series		100.9			610.8																																						
51:	10.0	↖																																																																									
52:	10.5x	←																																																																									
53:	10.0	↗																																																																									
54:	9.3	→																																																																									
55:	10.2x	↓																																																																									
56:	10.7x	↓																																																																									
57:	10.6x	↗																																																																									
58:	10.2x	↗																																																																									
59:	10.0	↗																																																																									
60:	9.4	↗																																																																									
Series		100.9																																																																									
		610.8																																																																									

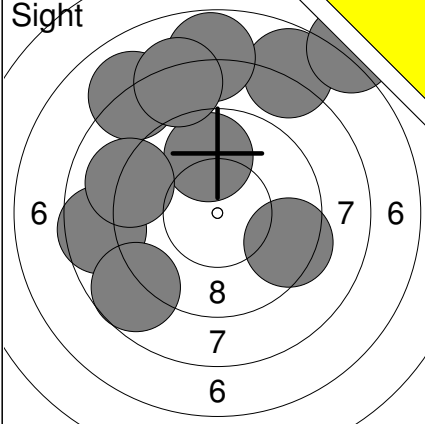
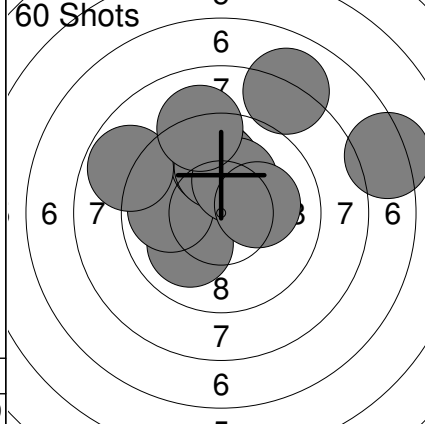
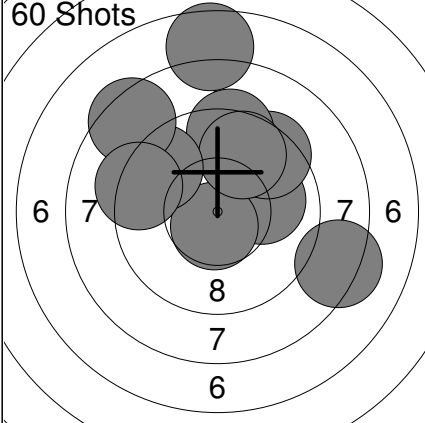
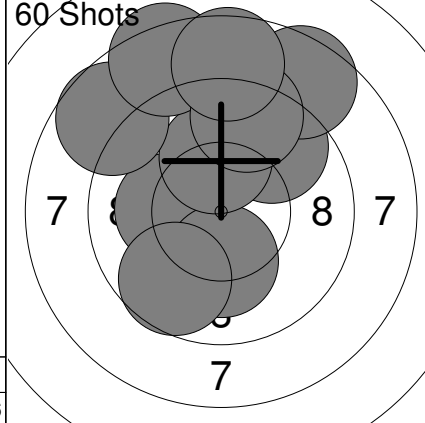
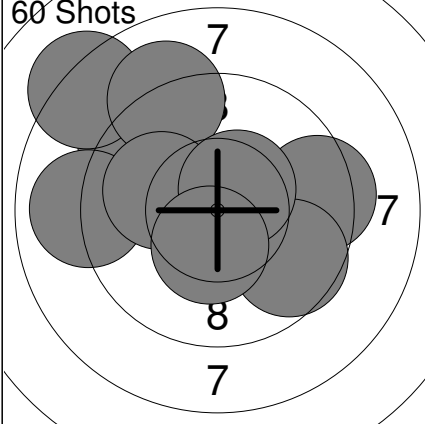
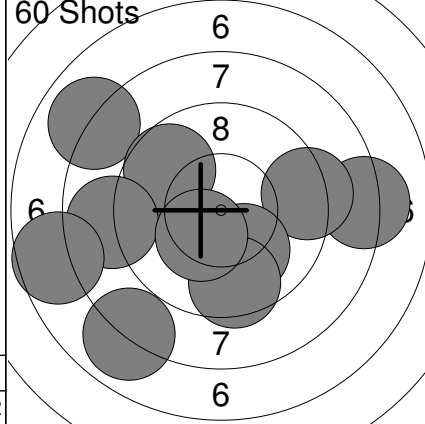
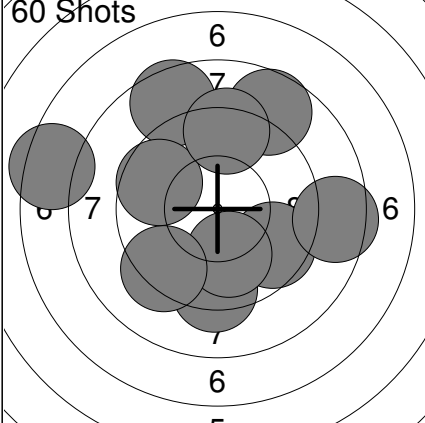
<p><b>Sight</b></p> 	<table border="1" style="width:100%; border-collapse: collapse;"> <tr><td>1: 7.8</td><td>↗</td></tr> <tr><td>2: 9.8</td><td>↑</td></tr> <tr><td>3: 9.4</td><td>→</td></tr> <tr><td>4: 8.6</td><td>←</td></tr> <tr><td>5: 7.8</td><td>↑</td></tr> <tr><td>6: 8.0</td><td>↗</td></tr> <tr><td>7: 9.1</td><td>↖</td></tr> <tr><td>8: 6.7</td><td>↗</td></tr> <tr><td>9: 8.2</td><td>↑</td></tr> <tr><td>10: 8.7</td><td>↘</td></tr> <tr><td colspan="2"><b>Series 84.1</b></td></tr> <tr><td colspan="2">0.0</td></tr> </table>	1: 7.8	↗	2: 9.8	↑	3: 9.4	→	4: 8.6	←	5: 7.8	↑	6: 8.0	↗	7: 9.1	↖	8: 6.7	↗	9: 8.2	↑	10: 8.7	↘	<b>Series 84.1</b>		0.0		<p><b>60 Shots</b></p> 	<table border="1" style="width:100%; border-collapse: collapse;"> <tr><td>1: 8.1</td><td>↗</td></tr> <tr><td>2: 10.0</td><td>↘</td></tr> <tr><td>3: 9.9</td><td>←</td></tr> <tr><td>4: 9.9</td><td>↑</td></tr> <tr><td>5: 8.8</td><td>↖</td></tr> <tr><td>6: 10.0</td><td>↑</td></tr> <tr><td>7: 10.2x</td><td>↑</td></tr> <tr><td>8: 9.1</td><td>↑</td></tr> <tr><td>9: 7.3</td><td>→</td></tr> <tr><td>10: 10.2x</td><td>→</td></tr> <tr><td colspan="2"><b>Series 93.5</b></td></tr> <tr><td colspan="2">93.5</td></tr> </table>	1: 8.1	↗	2: 10.0	↘	3: 9.9	←	4: 9.9	↑	5: 8.8	↖	6: 10.0	↑	7: 10.2x	↑	8: 9.1	↑	9: 7.3	→	10: 10.2x	→	<b>Series 93.5</b>		93.5	
1: 7.8	↗																																																		
2: 9.8	↑																																																		
3: 9.4	→																																																		
4: 8.6	←																																																		
5: 7.8	↑																																																		
6: 8.0	↗																																																		
7: 9.1	↖																																																		
8: 6.7	↗																																																		
9: 8.2	↑																																																		
10: 8.7	↘																																																		
<b>Series 84.1</b>																																																			
0.0																																																			
1: 8.1	↗																																																		
2: 10.0	↘																																																		
3: 9.9	←																																																		
4: 9.9	↑																																																		
5: 8.8	↖																																																		
6: 10.0	↑																																																		
7: 10.2x	↑																																																		
8: 9.1	↑																																																		
9: 7.3	→																																																		
10: 10.2x	→																																																		
<b>Series 93.5</b>																																																			
93.5																																																			
<p><b>60 Shots</b></p> 	<table border="1" style="width:100%; border-collapse: collapse;"> <tr><td>11: 10.0</td><td>→</td></tr> <tr><td>12: 9.4</td><td>↗</td></tr> <tr><td>13: 9.3</td><td>↑</td></tr> <tr><td>14: 7.6</td><td>↑</td></tr> <tr><td>15: 10.6x</td><td>↘</td></tr> <tr><td>16: 9.7</td><td>↑</td></tr> <tr><td>17: 8.3</td><td>↘</td></tr> <tr><td>18: 9.5</td><td>↗</td></tr> <tr><td>19: 8.4</td><td>↗</td></tr> <tr><td>20: 9.3</td><td>←</td></tr> <tr><td colspan="2"><b>Series 92.1</b></td></tr> <tr><td colspan="2">185.6</td></tr> </table>	11: 10.0	→	12: 9.4	↗	13: 9.3	↑	14: 7.6	↑	15: 10.6x	↘	16: 9.7	↑	17: 8.3	↘	18: 9.5	↗	19: 8.4	↗	20: 9.3	←	<b>Series 92.1</b>		185.6		<p><b>60 Shots</b></p> 	<table border="1" style="width:100%; border-collapse: collapse;"> <tr><td>21: 9.6</td><td>↗</td></tr> <tr><td>22: 10.2x</td><td>←</td></tr> <tr><td>23: 8.6</td><td>↗</td></tr> <tr><td>24: 10.2x</td><td>↓</td></tr> <tr><td>25: 10.1</td><td>↑</td></tr> <tr><td>26: 8.7</td><td>↖</td></tr> <tr><td>27: 8.4</td><td>↑</td></tr> <tr><td>28: 9.4</td><td>↑</td></tr> <tr><td>29: 8.6</td><td>↑</td></tr> <tr><td>30: 9.7</td><td>↘</td></tr> <tr><td colspan="2"><b>Series 93.5</b></td></tr> <tr><td colspan="2">279.1</td></tr> </table>	21: 9.6	↗	22: 10.2x	←	23: 8.6	↗	24: 10.2x	↓	25: 10.1	↑	26: 8.7	↖	27: 8.4	↑	28: 9.4	↑	29: 8.6	↑	30: 9.7	↘	<b>Series 93.5</b>		279.1	
11: 10.0	→																																																		
12: 9.4	↗																																																		
13: 9.3	↑																																																		
14: 7.6	↑																																																		
15: 10.6x	↘																																																		
16: 9.7	↑																																																		
17: 8.3	↘																																																		
18: 9.5	↗																																																		
19: 8.4	↗																																																		
20: 9.3	←																																																		
<b>Series 92.1</b>																																																			
185.6																																																			
21: 9.6	↗																																																		
22: 10.2x	←																																																		
23: 8.6	↗																																																		
24: 10.2x	↓																																																		
25: 10.1	↑																																																		
26: 8.7	↖																																																		
27: 8.4	↑																																																		
28: 9.4	↑																																																		
29: 8.6	↑																																																		
30: 9.7	↘																																																		
<b>Series 93.5</b>																																																			
279.1																																																			
<p><b>60 Shots</b></p> 	<table border="1" style="width:100%; border-collapse: collapse;"> <tr><td>31: 9.3</td><td>↗</td></tr> <tr><td>32: 9.0</td><td>←</td></tr> <tr><td>33: 8.2</td><td>↗</td></tr> <tr><td>34: 9.1</td><td>↗</td></tr> <tr><td>35: 10.0</td><td>←</td></tr> <tr><td>36: 10.6x</td><td>↘</td></tr> <tr><td>37: 9.4</td><td>→</td></tr> <tr><td>38: 9.6</td><td>↘</td></tr> <tr><td>39: 10.5x</td><td>↗</td></tr> <tr><td>40: 10.4x</td><td>↓</td></tr> <tr><td colspan="2"><b>Series 96.1</b></td></tr> <tr><td colspan="2">375.2</td></tr> </table>	31: 9.3	↗	32: 9.0	←	33: 8.2	↗	34: 9.1	↗	35: 10.0	←	36: 10.6x	↘	37: 9.4	→	38: 9.6	↘	39: 10.5x	↗	40: 10.4x	↓	<b>Series 96.1</b>		375.2		<p><b>60 Shots</b></p> 	<table border="1" style="width:100%; border-collapse: collapse;"> <tr><td>41: 8.2</td><td>→</td></tr> <tr><td>42: 9.2</td><td>→</td></tr> <tr><td>43: 10.1</td><td>↘</td></tr> <tr><td>44: 7.9</td><td>↗</td></tr> <tr><td>45: 9.7</td><td>↗</td></tr> <tr><td>46: 8.8</td><td>←</td></tr> <tr><td>47: 9.5</td><td>↓</td></tr> <tr><td>48: 7.6</td><td>←</td></tr> <tr><td>49: 10.3x</td><td>↘</td></tr> <tr><td>50: 7.9</td><td>↘</td></tr> <tr><td colspan="2"><b>Series 89.2</b></td></tr> <tr><td colspan="2">464.4</td></tr> </table>	41: 8.2	→	42: 9.2	→	43: 10.1	↘	44: 7.9	↗	45: 9.7	↗	46: 8.8	←	47: 9.5	↓	48: 7.6	←	49: 10.3x	↘	50: 7.9	↘	<b>Series 89.2</b>		464.4	
31: 9.3	↗																																																		
32: 9.0	←																																																		
33: 8.2	↗																																																		
34: 9.1	↗																																																		
35: 10.0	←																																																		
36: 10.6x	↘																																																		
37: 9.4	→																																																		
38: 9.6	↘																																																		
39: 10.5x	↗																																																		
40: 10.4x	↓																																																		
<b>Series 96.1</b>																																																			
375.2																																																			
41: 8.2	→																																																		
42: 9.2	→																																																		
43: 10.1	↘																																																		
44: 7.9	↗																																																		
45: 9.7	↗																																																		
46: 8.8	←																																																		
47: 9.5	↓																																																		
48: 7.6	←																																																		
49: 10.3x	↘																																																		
50: 7.9	↘																																																		
<b>Series 89.2</b>																																																			
464.4																																																			
<p><b>60 Shots</b></p> 	<table border="1" style="width:100%; border-collapse: collapse;"> <tr><td>51: 9.6</td><td>→</td></tr> <tr><td>52: 8.6</td><td>↗</td></tr> <tr><td>53: 9.3</td><td>↓</td></tr> <tr><td>54: 8.7</td><td>↗</td></tr> <tr><td>55: 10.0</td><td>↓</td></tr> <tr><td>56: 8.5</td><td>→</td></tr> <tr><td>57: 9.3</td><td>↘</td></tr> <tr><td>58: 7.4</td><td>←</td></tr> <tr><td>59: 9.6</td><td>←</td></tr> <tr><td>60: 9.3</td><td>↑</td></tr> <tr><td colspan="2"><b>Series 90.3</b></td></tr> <tr><td colspan="2">554.7</td></tr> </table>	51: 9.6	→	52: 8.6	↗	53: 9.3	↓	54: 8.7	↗	55: 10.0	↓	56: 8.5	→	57: 9.3	↘	58: 7.4	←	59: 9.6	←	60: 9.3	↑	<b>Series 90.3</b>		554.7																											
51: 9.6	→																																																		
52: 8.6	↗																																																		
53: 9.3	↓																																																		
54: 8.7	↗																																																		
55: 10.0	↓																																																		
56: 8.5	→																																																		
57: 9.3	↘																																																		
58: 7.4	←																																																		
59: 9.6	←																																																		
60: 9.3	↑																																																		
<b>Series 90.3</b>																																																			
554.7																																																			

Comment	Signature
---------	-----------

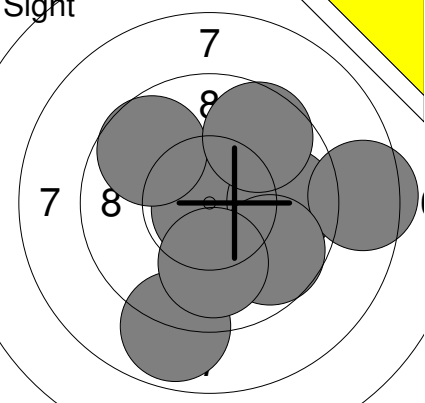
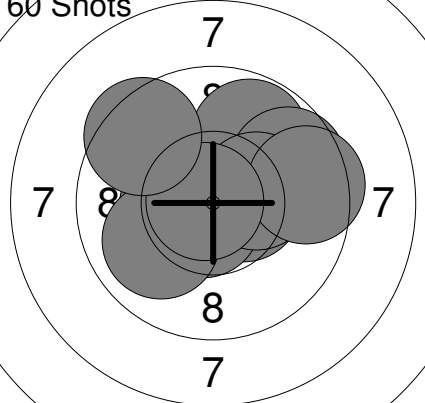
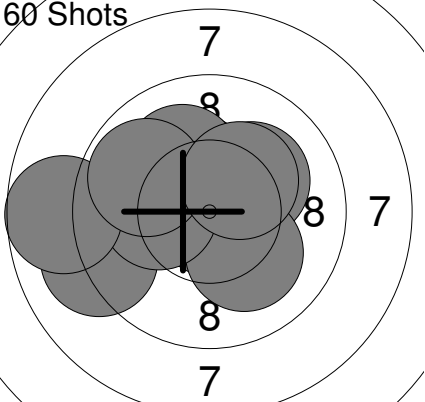
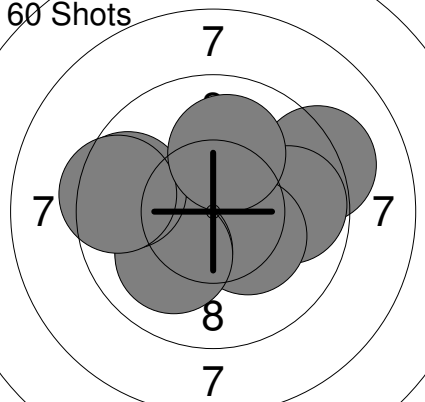
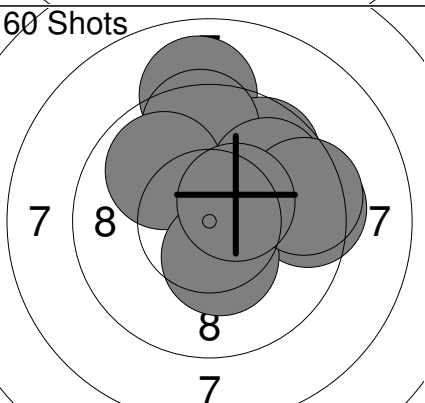
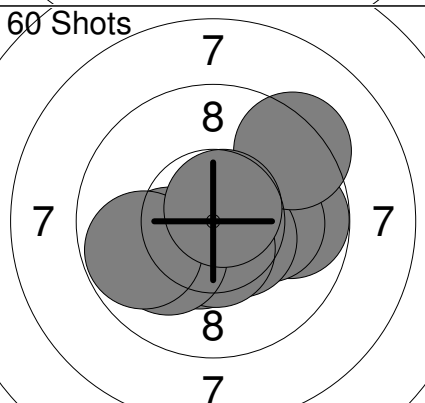
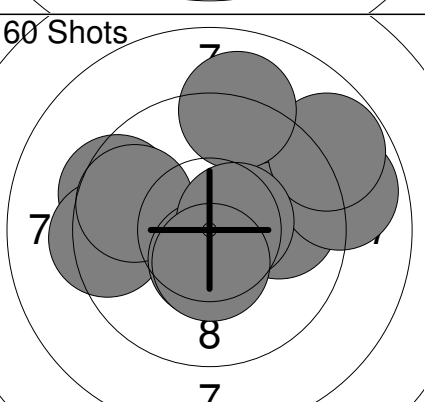
<b>Sight</b> 	<table border="1" style="width:100%; border-collapse: collapse;"> <tr><td>1:</td><td>10.8x</td><td>↘</td></tr> <tr><td>2:</td><td>8.9</td><td>↘</td></tr> <tr><td>3:</td><td>9.7</td><td>↗</td></tr> <tr><td>4:</td><td>9.8</td><td>→</td></tr> <tr><td>5:</td><td>8.4</td><td>→</td></tr> <tr><td>6:</td><td>9.7</td><td>↘</td></tr> <tr><td>7:</td><td>9.6</td><td>↗</td></tr> <tr><td>8:</td><td>10.0</td><td>↓</td></tr> <tr><td colspan="2"><b>Series</b></td><td>76.9</td></tr> <tr><td colspan="2"></td><td>0.0</td></tr> </table>	1:	10.8x	↘	2:	8.9	↘	3:	9.7	↗	4:	9.8	→	5:	8.4	→	6:	9.7	↘	7:	9.6	↗	8:	10.0	↓	<b>Series</b>		76.9			0.0	<b>60 Shots</b> 	<table border="1" style="width:100%; border-collapse: collapse;"> <tr><td>1:</td><td>9.8</td><td>↗</td></tr> <tr><td>2:</td><td>10.4x</td><td>←</td></tr> <tr><td>3:</td><td>9.7</td><td>↗</td></tr> <tr><td>4:</td><td>10.5x</td><td>→</td></tr> <tr><td>5:</td><td>10.7x</td><td>↘</td></tr> <tr><td>6:</td><td>10.3x</td><td>→</td></tr> <tr><td>7:</td><td>10.0</td><td>↙</td></tr> <tr><td>8:</td><td>9.5</td><td>→</td></tr> <tr><td>9:</td><td>10.8x</td><td>←</td></tr> <tr><td>10:</td><td>9.5</td><td>↖</td></tr> <tr><td colspan="2"><b>Series</b></td><td>101.2</td></tr> <tr><td colspan="2"></td><td>101.2</td></tr> </table>	1:	9.8	↗	2:	10.4x	←	3:	9.7	↗	4:	10.5x	→	5:	10.7x	↘	6:	10.3x	→	7:	10.0	↙	8:	9.5	→	9:	10.8x	←	10:	9.5	↖	<b>Series</b>		101.2			101.2						
1:	10.8x	↘																																																																									
2:	8.9	↘																																																																									
3:	9.7	↗																																																																									
4:	9.8	→																																																																									
5:	8.4	→																																																																									
6:	9.7	↘																																																																									
7:	9.6	↗																																																																									
8:	10.0	↓																																																																									
<b>Series</b>		76.9																																																																									
		0.0																																																																									
1:	9.8	↗																																																																									
2:	10.4x	←																																																																									
3:	9.7	↗																																																																									
4:	10.5x	→																																																																									
5:	10.7x	↘																																																																									
6:	10.3x	→																																																																									
7:	10.0	↙																																																																									
8:	9.5	→																																																																									
9:	10.8x	←																																																																									
10:	9.5	↖																																																																									
<b>Series</b>		101.2																																																																									
		101.2																																																																									
<b>60 Shots</b> 	<table border="1" style="width:100%; border-collapse: collapse;"> <tr><td>11:</td><td>10.2x</td><td>↗</td></tr> <tr><td>12:</td><td>10.3x</td><td>↗</td></tr> <tr><td>13:</td><td>9.1</td><td>←</td></tr> <tr><td>14:</td><td>10.1</td><td>↗</td></tr> <tr><td>15:</td><td>10.8x</td><td>↘</td></tr> <tr><td>16:</td><td>10.1</td><td>↘</td></tr> <tr><td>17:</td><td>10.2x</td><td>←</td></tr> <tr><td>18:</td><td>8.7</td><td>←</td></tr> <tr><td>19:</td><td>9.9</td><td>↗</td></tr> <tr><td>20:</td><td>10.3x</td><td>↗</td></tr> <tr><td colspan="2"><b>Series</b></td><td>99.7</td></tr> <tr><td colspan="2"></td><td>200.9</td></tr> </table>	11:	10.2x	↗	12:	10.3x	↗	13:	9.1	←	14:	10.1	↗	15:	10.8x	↘	16:	10.1	↘	17:	10.2x	←	18:	8.7	←	19:	9.9	↗	20:	10.3x	↗	<b>Series</b>		99.7			200.9	<b>60 Shots</b> 	<table border="1" style="width:100%; border-collapse: collapse;"> <tr><td>21:</td><td>10.1</td><td>↗</td></tr> <tr><td>22:</td><td>10.7x</td><td>↙</td></tr> <tr><td>23:</td><td>9.2</td><td>↗</td></tr> <tr><td>24:</td><td>9.8</td><td>→</td></tr> <tr><td>25:</td><td>10.3x</td><td>↘</td></tr> <tr><td>26:</td><td>10.1</td><td>↙</td></tr> <tr><td>27:</td><td>10.1</td><td>↙</td></tr> <tr><td>28:</td><td>9.6</td><td>←</td></tr> <tr><td>29:</td><td>9.5</td><td>←</td></tr> <tr><td>30:</td><td>10.0</td><td>↑</td></tr> <tr><td colspan="2"><b>Series</b></td><td>99.4</td></tr> <tr><td colspan="2"></td><td>300.3</td></tr> </table>	21:	10.1	↗	22:	10.7x	↙	23:	9.2	↗	24:	9.8	→	25:	10.3x	↘	26:	10.1	↙	27:	10.1	↙	28:	9.6	←	29:	9.5	←	30:	10.0	↑	<b>Series</b>		99.4			300.3
11:	10.2x	↗																																																																									
12:	10.3x	↗																																																																									
13:	9.1	←																																																																									
14:	10.1	↗																																																																									
15:	10.8x	↘																																																																									
16:	10.1	↘																																																																									
17:	10.2x	←																																																																									
18:	8.7	←																																																																									
19:	9.9	↗																																																																									
20:	10.3x	↗																																																																									
<b>Series</b>		99.7																																																																									
		200.9																																																																									
21:	10.1	↗																																																																									
22:	10.7x	↙																																																																									
23:	9.2	↗																																																																									
24:	9.8	→																																																																									
25:	10.3x	↘																																																																									
26:	10.1	↙																																																																									
27:	10.1	↙																																																																									
28:	9.6	←																																																																									
29:	9.5	←																																																																									
30:	10.0	↑																																																																									
<b>Series</b>		99.4																																																																									
		300.3																																																																									
<b>60 Shots</b> 	<table border="1" style="width:100%; border-collapse: collapse;"> <tr><td>31:</td><td>10.5x</td><td>↑</td></tr> <tr><td>32:</td><td>9.0</td><td>↑</td></tr> <tr><td>33:</td><td>9.7</td><td>↗</td></tr> <tr><td>34:</td><td>9.5</td><td>↑</td></tr> <tr><td>35:</td><td>9.4</td><td>→</td></tr> <tr><td>36:</td><td>9.8</td><td>↗</td></tr> <tr><td>37:</td><td>9.9</td><td>↗</td></tr> <tr><td>38:</td><td>10.4x</td><td>↘</td></tr> <tr><td>39:</td><td>9.5</td><td>→</td></tr> <tr><td>40:</td><td>10.5x</td><td>↗</td></tr> <tr><td colspan="2"><b>Series</b></td><td>98.2</td></tr> <tr><td colspan="2"></td><td>398.5</td></tr> </table>	31:	10.5x	↑	32:	9.0	↑	33:	9.7	↗	34:	9.5	↑	35:	9.4	→	36:	9.8	↗	37:	9.9	↗	38:	10.4x	↘	39:	9.5	→	40:	10.5x	↗	<b>Series</b>		98.2			398.5	<b>60 Shots</b> 	<table border="1" style="width:100%; border-collapse: collapse;"> <tr><td>41:</td><td>9.8</td><td>→</td></tr> <tr><td>42:</td><td>10.1</td><td>→</td></tr> <tr><td>43:</td><td>10.5x</td><td>↘</td></tr> <tr><td>44:</td><td>10.5x</td><td>↘</td></tr> <tr><td>45:</td><td>9.3</td><td>↗</td></tr> <tr><td>46:</td><td>10.5x</td><td>↓</td></tr> <tr><td>47:</td><td>10.2x</td><td>↙</td></tr> <tr><td>48:</td><td>10.1</td><td>↙</td></tr> <tr><td>49:</td><td>9.8</td><td>←</td></tr> <tr><td>50:</td><td>10.7x</td><td>↗</td></tr> <tr><td colspan="2"><b>Series</b></td><td>101.5</td></tr> <tr><td colspan="2"></td><td>500.0</td></tr> </table>	41:	9.8	→	42:	10.1	→	43:	10.5x	↘	44:	10.5x	↘	45:	9.3	↗	46:	10.5x	↓	47:	10.2x	↙	48:	10.1	↙	49:	9.8	←	50:	10.7x	↗	<b>Series</b>		101.5			500.0
31:	10.5x	↑																																																																									
32:	9.0	↑																																																																									
33:	9.7	↗																																																																									
34:	9.5	↑																																																																									
35:	9.4	→																																																																									
36:	9.8	↗																																																																									
37:	9.9	↗																																																																									
38:	10.4x	↘																																																																									
39:	9.5	→																																																																									
40:	10.5x	↗																																																																									
<b>Series</b>		98.2																																																																									
		398.5																																																																									
41:	9.8	→																																																																									
42:	10.1	→																																																																									
43:	10.5x	↘																																																																									
44:	10.5x	↘																																																																									
45:	9.3	↗																																																																									
46:	10.5x	↓																																																																									
47:	10.2x	↙																																																																									
48:	10.1	↙																																																																									
49:	9.8	←																																																																									
50:	10.7x	↗																																																																									
<b>Series</b>		101.5																																																																									
		500.0																																																																									
<b>60 Shots</b> 	<table border="1" style="width:100%; border-collapse: collapse;"> <tr><td>51:</td><td>9.4</td><td>←</td></tr> <tr><td>52:</td><td>9.4</td><td>←</td></tr> <tr><td>53:</td><td>9.7</td><td>←</td></tr> <tr><td>54:</td><td>9.9</td><td>→</td></tr> <tr><td>55:</td><td>10.5x</td><td>↓</td></tr> <tr><td>56:</td><td>8.9</td><td>→</td></tr> <tr><td>57:</td><td>8.8</td><td>↗</td></tr> <tr><td>58:</td><td>9.1</td><td>↑</td></tr> <tr><td>59:</td><td>10.5x</td><td>→</td></tr> <tr><td>60:</td><td>10.5x</td><td>↓</td></tr> <tr><td colspan="2"><b>Series</b></td><td>96.7</td></tr> <tr><td colspan="2"></td><td>596.7</td></tr> </table>	51:	9.4	←	52:	9.4	←	53:	9.7	←	54:	9.9	→	55:	10.5x	↓	56:	8.9	→	57:	8.8	↗	58:	9.1	↑	59:	10.5x	→	60:	10.5x	↓	<b>Series</b>		96.7			596.7																																						
51:	9.4	←																																																																									
52:	9.4	←																																																																									
53:	9.7	←																																																																									
54:	9.9	→																																																																									
55:	10.5x	↓																																																																									
56:	8.9	→																																																																									
57:	8.8	↗																																																																									
58:	9.1	↑																																																																									
59:	10.5x	→																																																																									
60:	10.5x	↓																																																																									
<b>Series</b>		96.7																																																																									
		596.7																																																																									



Relay **3** Lane **1** **LUO Max fangzhi**

2023 Western Cdn Air Gur BC JR MP

14.10.2023 2023 WCAGC Qualifier Alberta Handgun Association

Comment Signature

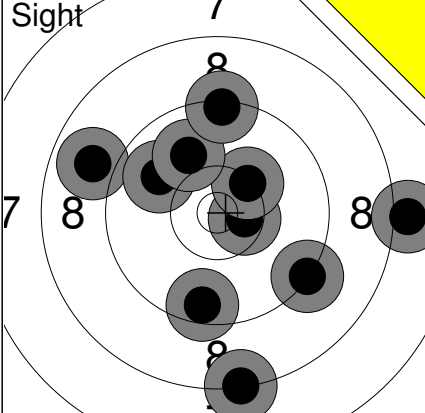
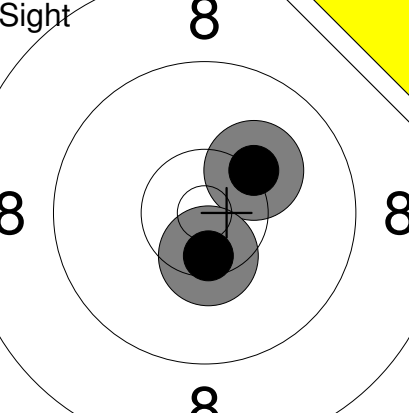
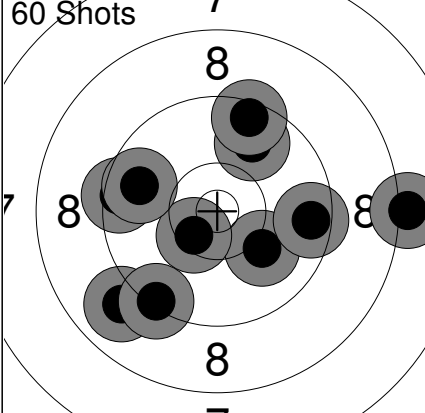
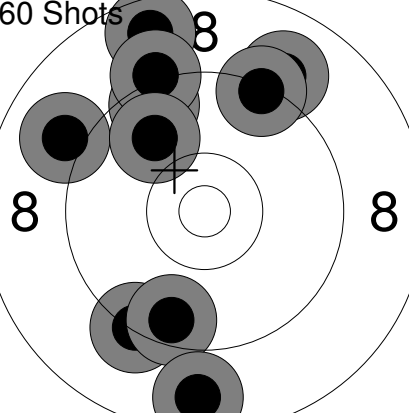
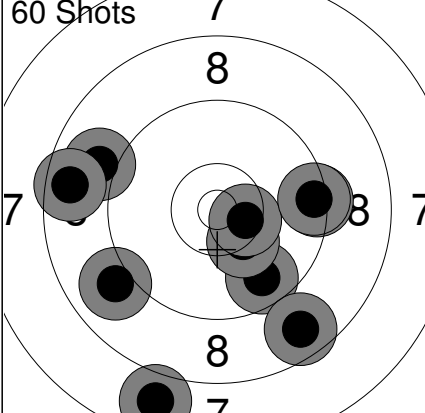
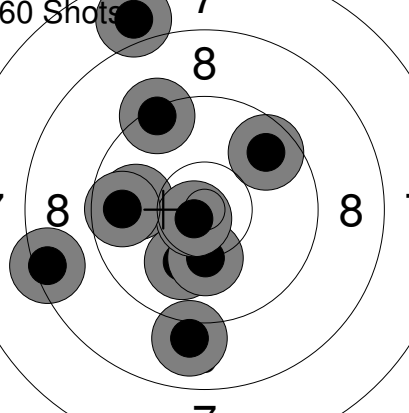
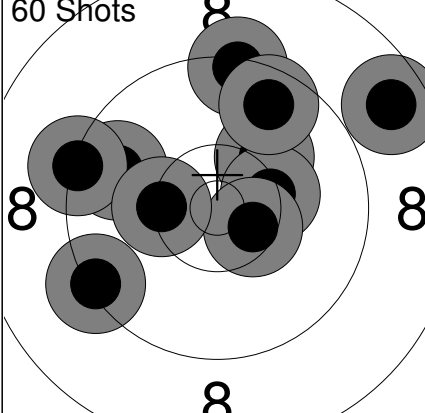
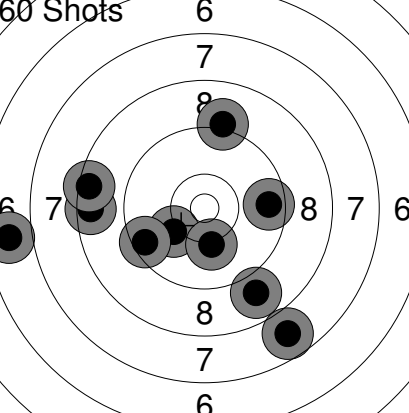
<p>Sight</p> 	<p>1: 8.3 ↓ 2: 10.5x → 3: 8.0 → 4: 8.9 ↖ 5: 10.3 ↗ 6: 9.3 ↘ 7: 9.9 ↗ 8: 10.0 ↗ 9: 9.3 ↑ 10: 9.5 ↓</p> <p>Series 90 (1x) 0 (0x)</p>	<p>Sight</p> 	<p>11: 10.2 ↗ 12: 10.5x ↓</p> <p>Series 20 (1x) 0 (0x)</p>
<p>60 Shots</p> 	<p>1: 9.8 ↗ 2: 10.1 ↘ 3: 8.1 → 4: 9.5 ← 5: 10.4x ← 6: 9.5 → 7: 9.5 ↗ 8: 9.7 ← 9: 8.9 ↘ 10: 9.3 ↘</p> <p>Series 90 (1x) 90 (1x)</p>	<p>60 Shots</p> 	<p>11: 9.0 ← 12: 9.5 ↗ 13: 8.6 ↗ 14: 9.3 ↘ 15: 9.5 ↘ 16: 9.2 ↗ 17: 9.9 ↗ 18: 8.7 ↓ 19: 9.0 ↗ 20: 9.3 ↗</p> <p>Series 88 (0x) 178 (1x)</p>
<p>60 Shots</p> 	<p>21: 9.7 ↘ 22: 7.8 ↘ 23: 10.3 ↘ 24: 9.4 → 25: 9.0 ← 26: 10.5x → 27: 8.7 ↘ 28: 9.0 ← 29: 9.4 → 30: 8.6 ←</p> <p>Series 88 (1x) 266 (2x)</p>	<p>60 Shots</p> 	<p>31: 9.0 ↓ 32: 10.1 ↓ 33: 9.9 ← 34: 10.2 ↓ 35: 9.7 ↗ 36: 10.7x ← 37: 9.4 ↗ 38: 7.9 ↗ 39: 9.7 ← 40: 8.4 ←</p> <p>Series 90 (1x) 356 (3x)</p>
<p>60 Shots</p> 	<p>41: 9.3 ↑ 42: 10.2 ↗ 43: 8.7 → 44: 10.3 → 45: 9.7 ← 46: 9.3 ← 47: 9.6 ↗ 48: 10.5x → 49: 10.3 ← 50: 9.3 ↘</p> <p>Series 93 (1x) 449 (4x)</p>	<p>60 Shots</p> 	<p>51: 6.7 ← 52: 8.5 ← 53: 9.1 ↗ 54: 10.1 ← 55: 10.2 ↓ 56: 8.5 ← 57: 8.8 ↓ 58: 9.6 → 59: 9.5 ← 60: 7.7 ↘</p> <p>Series 84 (0x) 533 (4x)</p>

Relay **3** Lane **2** **ZHOU Mo**

2023 Western Cdn Air Gun BC JR MP

14.10.2023 2023 WCAGC Qualifier Alberta Handgun Association

Comment Signature

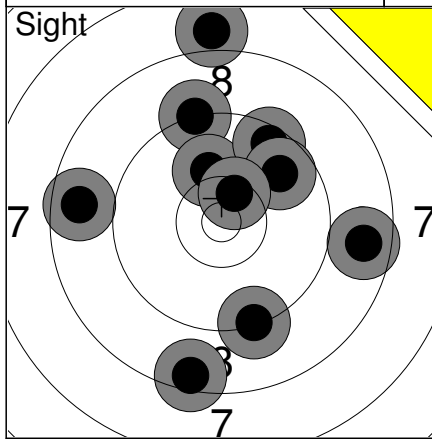

1:	9.2	↑
2:	10.1	↑↑
3:	9.5	↑
4:	8.7	←
5:	9.8	↗
6:	8.7	→
7:	7.9	↑
8:	9.3	↓
9:	8.5	↓
10:	10.4x	↑
Series	87 (1x)	
	0 (0x)	

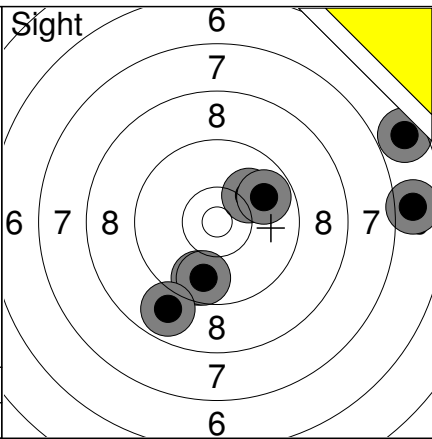

11:	6.6	↗
12:	9.7	↓
13:	6.9	→
14:	10.1	↗
15:	9.7	↓
16:	9.8	↗
17:	8.9	↓
Series	57 (0x)	
	0 (0x)	

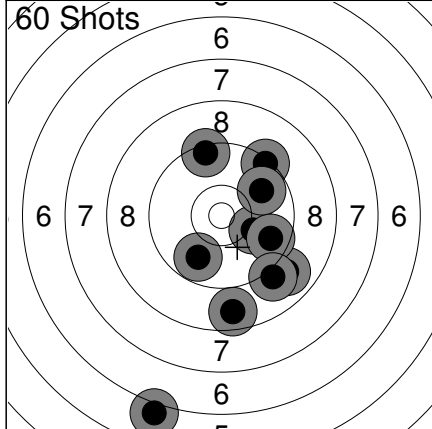

1:	10.1	→
2:	8.9	↘
3:	9.3	↗
4:	9.4	↑
5:	8.7	↓
6:	9.7	→
7:	9.1	↘
8:	9.8	↗
9:	9.8	↓
10:	6.0	↓
Series	86 (0x)	
	86 (0x)	

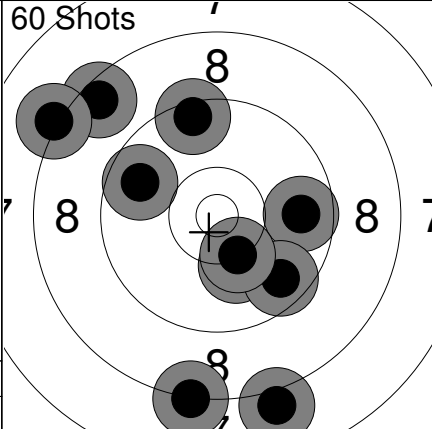

11:	8.0	↓
12:	10.2	↓
13:	9.7	→
14:	8.5	↗
15:	9.6	↓
16:	9.7	↗
17:	8.2	↗
18:	10.3	↓
19:	9.4	↑
20:	8.2	↓
Series	88 (0x)	
	174 (0x)	

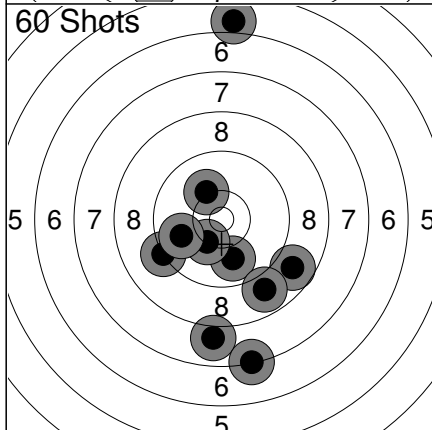

21:	9.9	↓
22:	9.2	←
23:	10.3	↓
24:	10.2	↗
25:	7.9	↓
26:	8.8	↘
27:	9.8	←
28:	5.9	↑
29:	7.3	↓
30:	8.9	↓
Series	82 (0x)	
	256 (0x)	

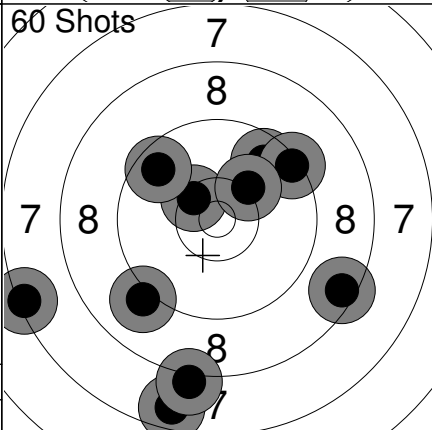

31:	9.7	↗
32:	7.6	↓
33:	10.4x	↗
34:	9.6	↗
35:	9.4	↗
36:	10.2	↗
37:	7.3	←
38:	9.1	↓
39:	8.1	↓
40:	8.5	↘
Series	86 (1x)	
	342 (1x)	

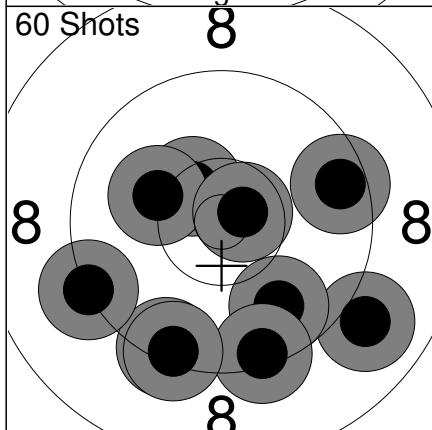

41:	9.5	→
42:	9.0	↘
43:	10.4x	↗
44:	9.8	↓
45:	9.4	↓
46:	10.2	↗
47:	9.3	←
48:	10.7x	→
49:	9.4	↓
50:	9.4	↓
Series	93 (2x)	
	435 (3x)	

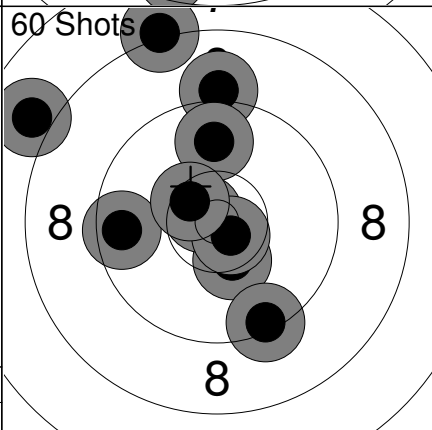

51:	10.4x	↓
52:	9.4	↓
53:	9.1	↑
54:	10.7x	↗
55:	8.1	↑
56:	9.8	↑
57:	10.7x	↘
58:	9.6	←
59:	10.5x	↗
60:	7.9	↗
Series	91 (4x)	
	526 (7x)	

Relay **3** Lane **3** **HUANG Weilun (allen)**

2023 Western Cdn Air Gur BC JR MP

14.10.2023 2023 WCAGC Qualifier Alberta Handgun Association

Comment Signature

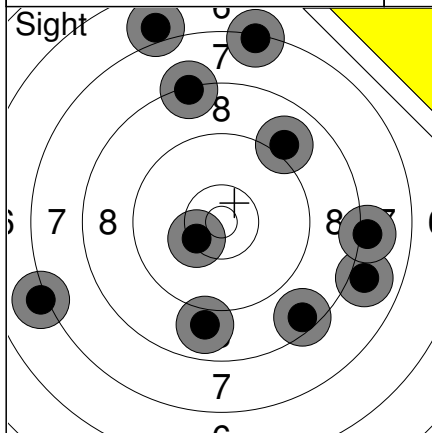

1:	8.9	↓
2:	7.3	↑
3:	8.0	→
4:	10.4x	←
5:	6.9	↑
6:	8.1	→
7:	9.0	↗
8:	8.3	↑
9:	8.5	↓
10:	7.1	←
Series	79 (1x)	
	0 (0x)	

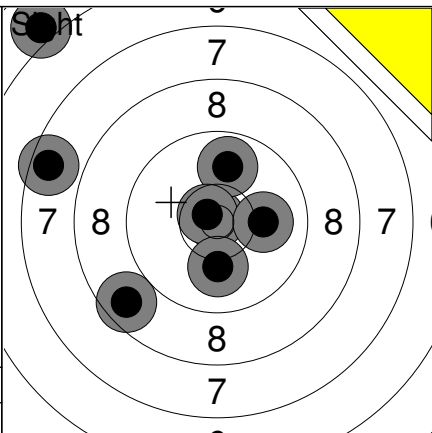

11:	6.0	↗
12:	7.6	←
13:	10.9x	↗
14:	9.9	↑
15:	10.7x	↗
16:	8.7	↙
17:	10.1	→
18:	10.1	↓
Series	70 (2x)	
	0 (0x)	

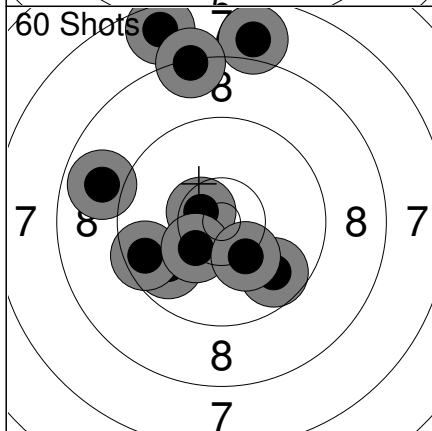

1:	7.9	↑
2:	10.6x	←
3:	7.6	↑
4:	9.8	↓
5:	9.8	↙
6:	8.3	↑
7:	9.6	←
8:	8.9	←
9:	10.3	↙
10:	10.2	↓
Series	87 (1x)	
	87 (1x)	

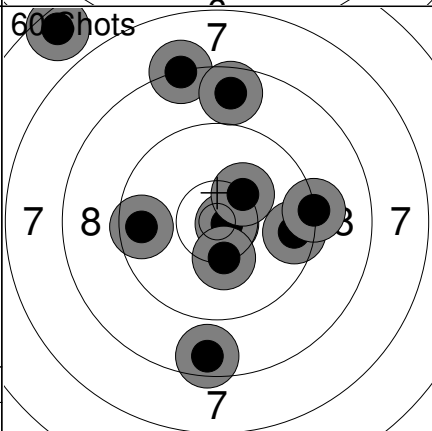

11:	8.3	↑
12:	10.8x	→
13:	9.6	→
14:	10.3	↗
15:	8.6	↓
16:	9.6	←
17:	9.2	→
18:	10.3	↓
19:	6.6	↗
20:	8.7	↑
Series	87 (1x)	
	174 (2x)	

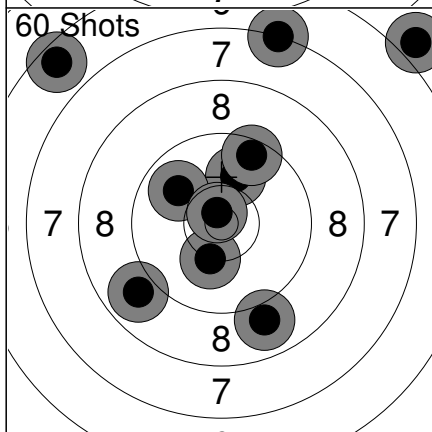

21:	10.0	↑
22:	9.5	↑
23:	6.6	↗
24:	9.9	↗
25:	10.2	↓
26:	10.7x	↗
27:	8.9	↙
28:	7.2	↑
29:	8.9	↓
30:	5.9	↗
Series	82 (1x)	
	256 (3x)	

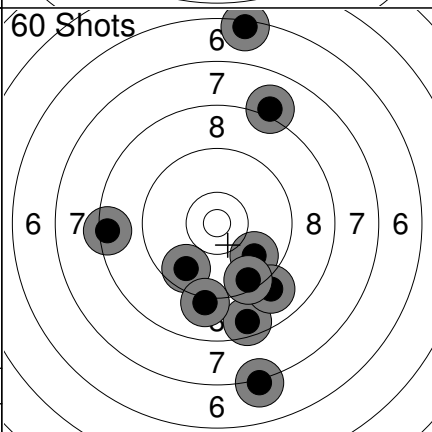

31:	9.7	↙
32:	7.2	↓
33:	9.8	↙
34:	8.1	↑
35:	8.6	↓
36:	9.0	↓
37:	9.1	↓
38:	9.5	↓
39:	8.4	←
40:	6.4	↑
Series	82 (0x)	
	338 (3x)	

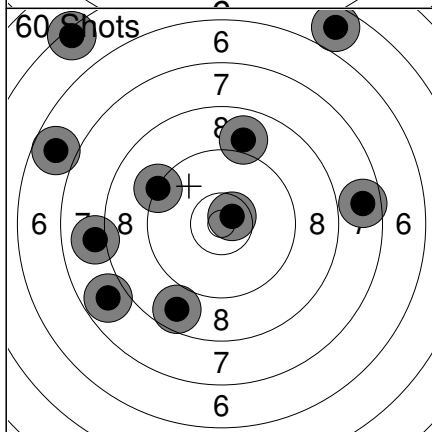

41:	5.7	↗
42:	10.7x	↗
43:	6.8	←
44:	9.3	↙
45:	8.9	↑
46:	7.8	←
47:	8.0	←
48:	8.7	↓
49:	7.6	→
50:	5.4	↗
Series	73 (1x)	
	411 (4x)	

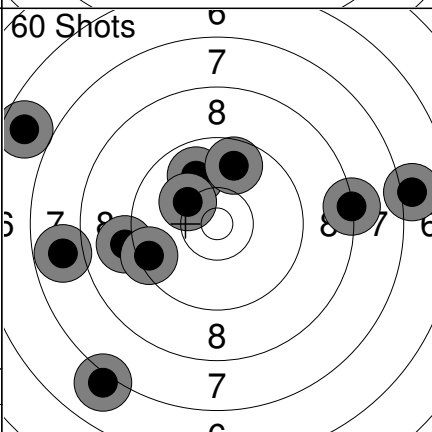

51:	9.1	←
52:	7.8	←
53:	9.9	↑
54:	9.5	←
55:	7.1	↙
56:	7.0	→
57:	6.7	↙
58:	9.7	↑
59:	8.3	→
60:	10.2	↙
Series	81 (0x)	
	492 (4x)	

Relay **3** Lane **4** **FU Daniel yuhui**

2023 Western Cdn Air Gur BC JR MP

14.10.2023 2023 WCAGC Qualifier Alberta Handgun Association

Comment Signature

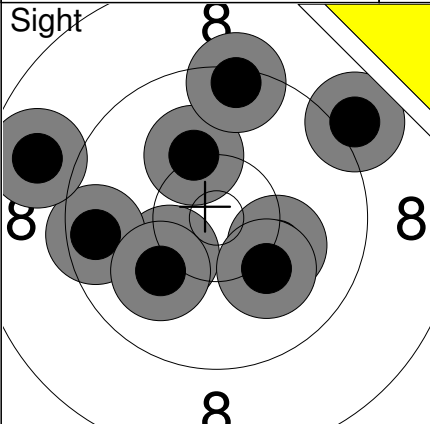
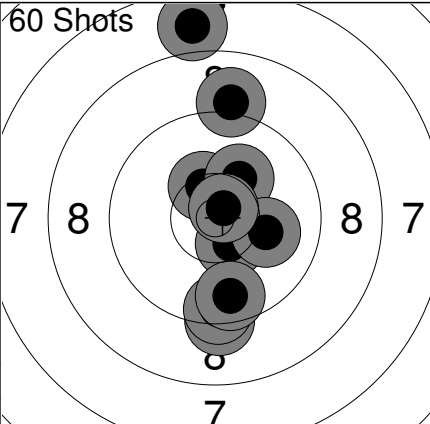
	1: 10.2 ↑ 2: 9.4 ↑ 3: 10.2 → 4: 10.3 ← 5: 9.0 → 6: 9.6 ← 7: 10.1 ← 8: 8.8 ← 9: 10.1 ↓		1: 10.5x ↓ 2: 10.4x ↑ 3: 10.2 ↑ 4: 10.1 → 5: 9.3 ↓ 6: 9.5 ↓ 7: 7.8 ↑ 8: 10.7x ↑ 9: 9.1 ↑ 10: 9.7 ↓
	Series 85 (0x) 0 (0x)		Series 93 (3x) 93 (3x)

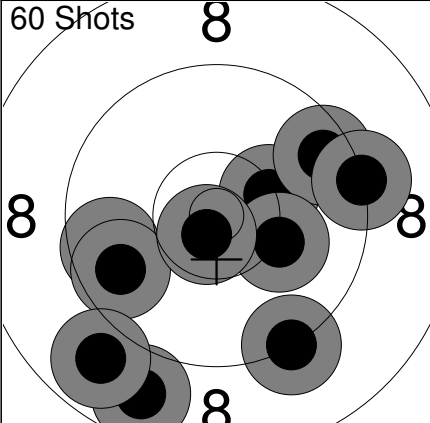
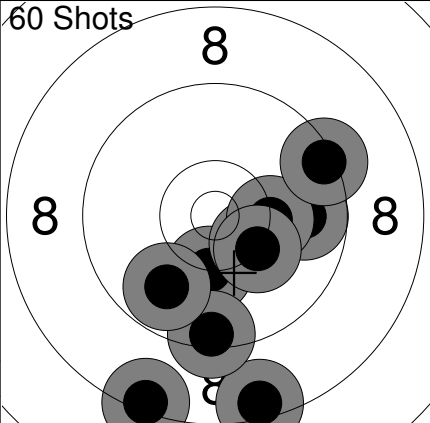
	11: 9.7 ← 12: 9.3 ↓ 13: 10.3 → 14: 9.6 → 15: 8.8 ↓ 16: 9.7 ← 17: 10.2 → 18: 10.7x ↓ 19: 8.9 ↓ 20: 9.2 →		21: 9.8 → 22: 8.4 ↓ 23: 10.2 ↓ 24: 9.4 ↓ 25: 10.3 ↓ 26: 10.2 → 27: 10.2 ↓ 28: 9.4 → 29: 9.8 ↓ 30: 8.4 ↓
	Series 91 (1x) 184 (4x)		Series 92 (0x) 276 (4x)

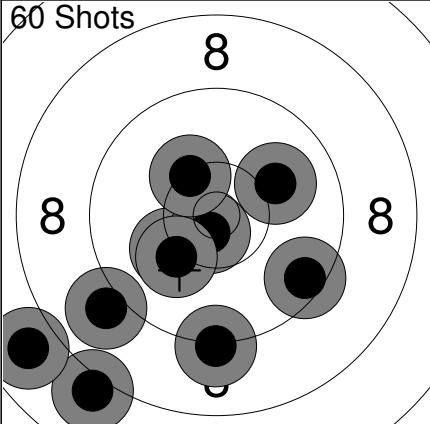
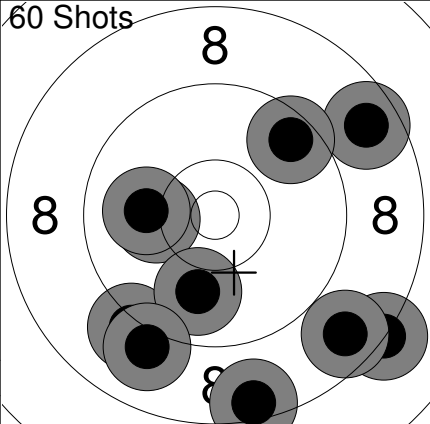
	31: 10.0 → 32: 9.5 ↓ 33: 8.0 ↓ 34: 10.2 ← 35: 9.0 ← 36: 10.7x ↓ 37: 7.8 ← 38: 10.2 ← 39: 10.3 ↑ 40: 9.2 ↓		41: 8.2 ↓ 42: 10.2 ← 43: 8.7 → 44: 9.6 ↑ 45: 9.1 ↓ 46: 9.9 ↓ 47: 9.0 ↓ 48: 10.0 ← 49: 8.6 ↓ 50: 8.5 ↓
	Series 92 (1x) 368 (5x)		Series 88 (0x) 456 (5x)

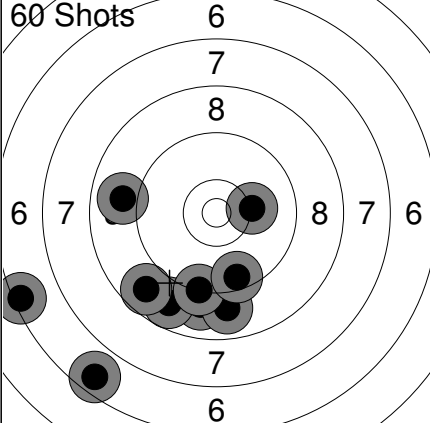
	51: 9.0 ↓ 52: 8.8 ↓ 53: 8.9 ↓ 54: 8.9 ← 55: 9.3 ↓ 56: 10.2 → 57: 6.6 ↓ 58: 8.7 ↓ 59: 9.5 ↓ 60: 6.4 ←		
	Series 81 (0x) 537 (5x)		

Relay **3** Lane **5** **NICOL Sophia ting**

2023 Western Cdn Air Gur BC JR WP

14.10.2023 2023 WCAGC Qualifier Alberta Handgun Association

Comment Signature

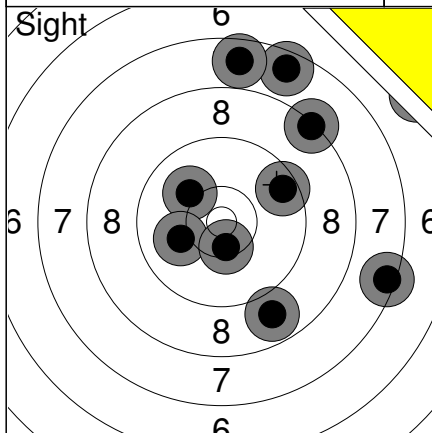

1:	7.6	↑
2:	7.7	↑
3:	10.1	↖
4:	8.3	↗
5:	6.2	↗
6:	10.1	←
7:	7.4	→
8:	8.8	↓
9:	10.4x	↓
10:	9.5	→
Series	82 (1x)	
	0 (0x)	

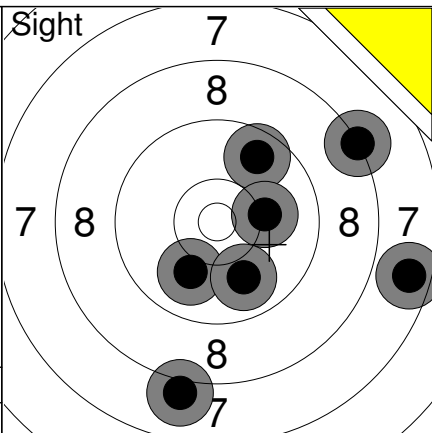

11:	8.2	↗
12:	9.7	↗
13:	10.1	→
14:	10.0	↓
15:	7.6	→
16:	8.0	↓
17:	9.9	↓
Series	61 (0x)	
	0 (0x)	

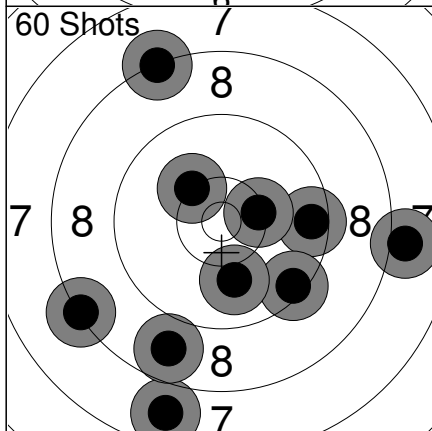

1:	9.5	→
2:	10.3	→
3:	9.4	↘
4:	10.2	↗
5:	10.0	↓
6:	8.2	↗
7:	7.8	↓
8:	8.7	↓
9:	8.3	↙
10:	8.0	→
Series	87 (0x)	
	87 (0x)	

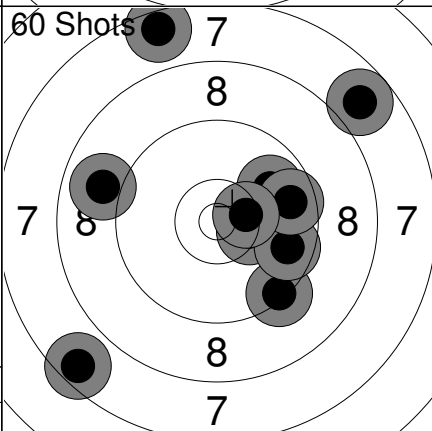

11:	9.9	↗
12:	10.4x	→
13:	9.3	↘
14:	9.7	→
15:	8.9	←
16:	9.7	→
17:	7.6	↙
18:	7.5	↑
19:	10.5x	→
20:	7.8	↗
Series	85 (2x)	
	172 (2x)	

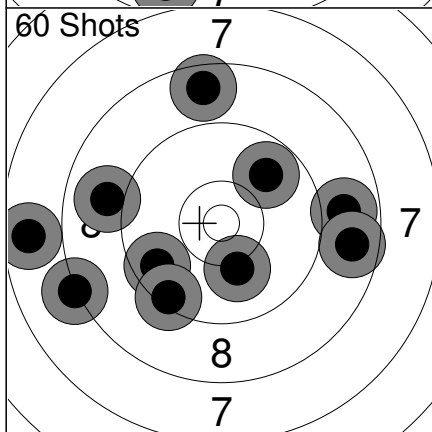

21:	8.6	↑
22:	9.8	↗
23:	8.9	→
24:	9.6	←
25:	7.7	←
26:	9.4	↓
27:	10.1	↓
28:	8.7	→
29:	8.2	←
30:	9.0	←
Series	85 (0x)	
	257 (2x)	

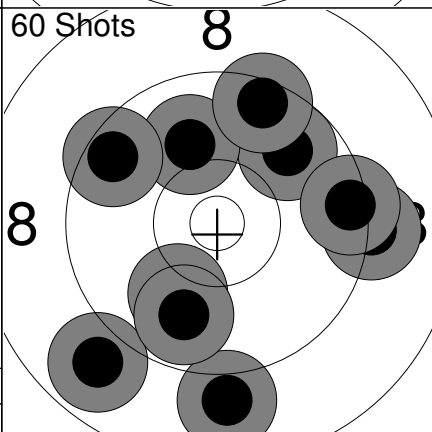

31:	8.9	↓
32:	9.8	↗
33:	8.9	↙
34:	9.2	→
35:	10.0	↓
36:	10.0	↑
37:	9.8	↓
38:	9.5	↑
39:	9.5	↖
40:	9.4	→
Series	90 (0x)	
	347 (2x)	

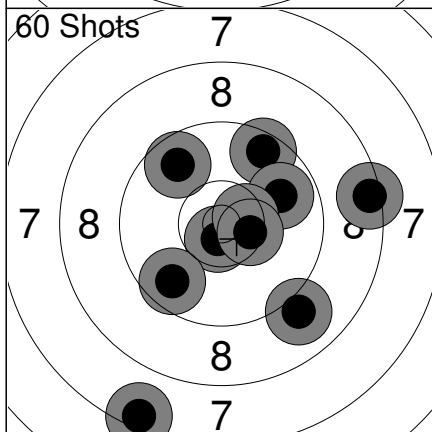

41:	9.7	↗
42:	7.4	↘
43:	9.5	↗
44:	10.7x	↓
45:	9.7	↙
46:	9.9	→
47:	9.0	↓
48:	10.5x	→
49:	10.4x	→
50:	8.4	→
Series	90 (3x)	
	437 (5x)	

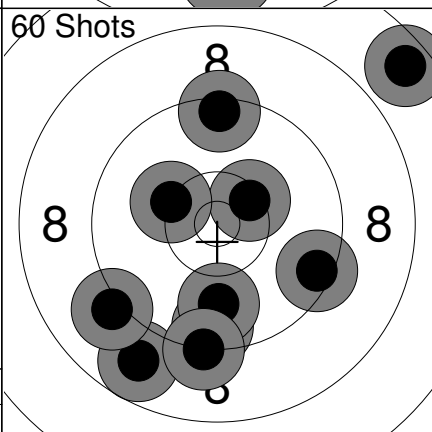

51:	9.5	↓
52:	9.4	↑
53:	7.6	↗
54:	10.4x	↗
55:	9.8	↓
56:	8.8	↘
57:	10.3	↖
58:	9.4	→
59:	9.1	↙
60:	9.2	↓
Series	89 (1x)	
	526 (6x)	

Relay <b>3</b>	Lane <b>7</b>	<b>BAO Justin jc</b>
-------------------	------------------	----------------------

2023 Western Cdn Air Gur BC	JR	MR
-----------------------------	----	----

14.10.2023	2023 WCAGC Qualifier	Alberta Handgun Association
------------	----------------------	-----------------------------

Comment	Signature
---------	-----------

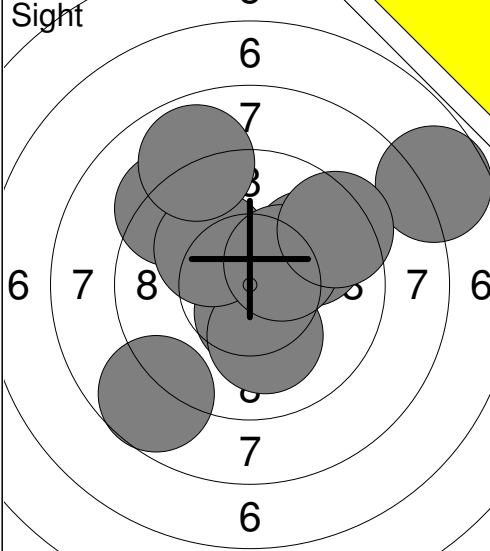
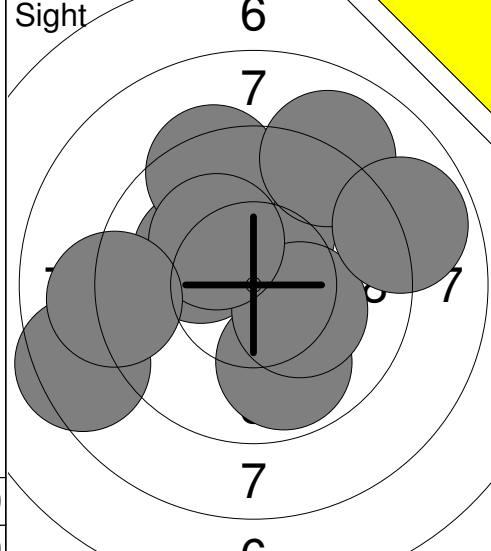
<p>Sight</p>  <p style="text-align: center;">6 7 8 7 6</p>	<p>1: 10.5x ↓ 2: 10.1 ↓ 3: 7.7 → 4: 9.3 ↖ 5: 9.9 → 6: 8.7 ↙ 7: 10.1 ↗ 8: 8.9 ↑ 9: 10.4x ↗ 10: 9.4 ↗</p> <p>Series 95.0 0.0</p>	<p>Sight</p> <p style="text-align: center;">6 7 7</p>  <p style="text-align: center;">6 7 7</p> <p>11: 9.9 ↓ 12: 10.2x ↖ 13: 10.2x ↑ 14: 9.4 ↑ 15: 10.3x → 16: 10.2x ↖ 17: 8.5 ← 18: 9.1 ← 19: 9.0 ↑ 20: 8.8 →</p> <p>Series 95.6 0.0</p>
--	--	---

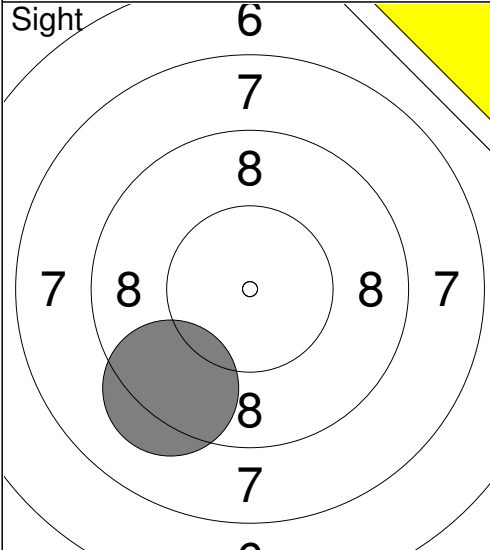
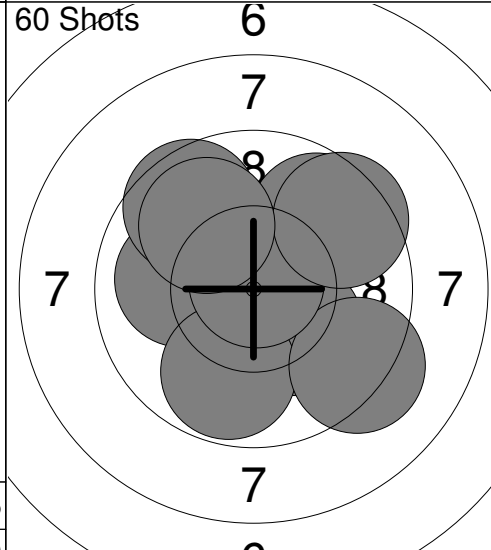
<p>Sight</p>  <p style="text-align: center;">6 7 8 7</p>	<p>21: 9.3 ↓</p> <p>Series 9.3 0.0</p>	<p>60 Shots</p> <p style="text-align: center;">6 7 7</p>  <p style="text-align: center;">6 7 7</p> <p>1: 9.7 ↗ 2: 10.1 ↖ 3: 10.0 ← 4: 10.2x → 5: 9.8 ↓ 6: 9.2 → 7: 9.6 ↗ 8: 10.8x ↑ 9: 9.5 ↗ 10: 9.9 ↖</p> <p>Series 98.8 98.8</p>
---	--	---

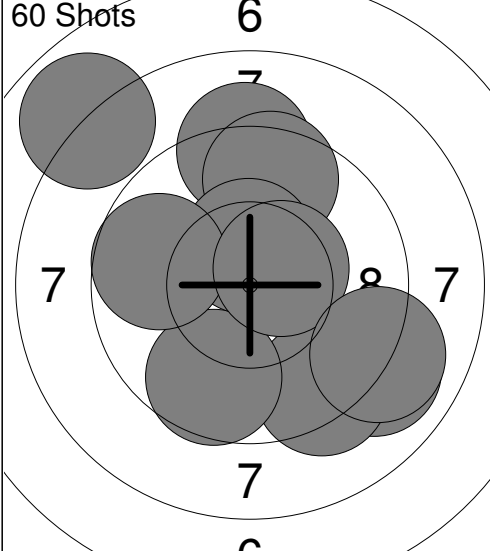
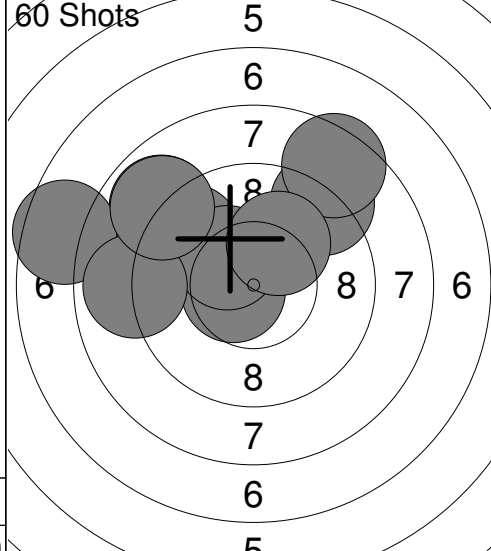
<p>60 Shots</p> <p style="text-align: center;">6 7 7</p>  <p style="text-align: center;">6 7 7</p>	<p>11: 9.0 → 12: 7.9 ↗ 13: 9.3 ↓ 14: 9.2 ↑ 15: 9.6 ↓ 16: 9.5 ↑ 17: 10.4x ↑ 18: 9.7 ← 19: 10.5x → 20: 9.0 →</p> <p>Series 94.1 192.9</p>	<p>60 Shots</p> <p style="text-align: center;">5 6 7 8 7 6</p>  <p style="text-align: center;">5 6 7 8 7 6</p> <p>21: 8.9 ↖ 22: 7.6 ← 23: 9.5 ↖ 24: 9.1 ↗ 25: 10.6x ← 26: 10.3x ↖ 27: 8.5 ↗ 28: 8.9 ← 29: 8.9 ↖ 30: 10.1 ↑</p> <p>Series 92.4 285.3</p>
--	---	---

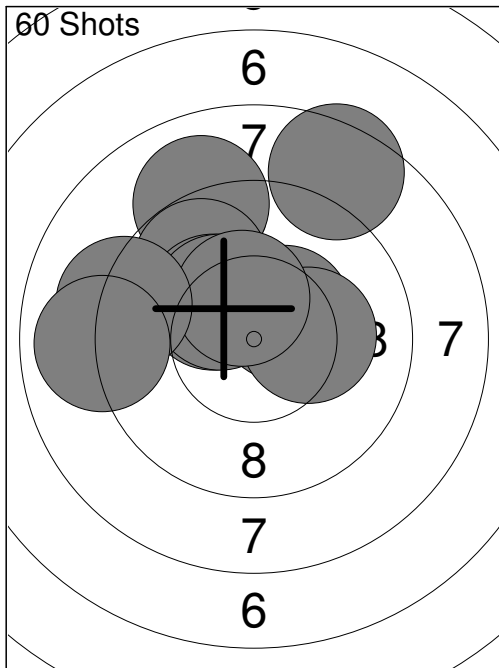

31:	8.5	↗
32:	10.4x	↗
33:	9.0	↗
34:	9.8	↗
35:	10.2x	↖
36:	10.3x	↖
37:	10.2x	→
38:	10.4x	↗
39:	9.2	←
40:	8.9	←
Series	96.9	
	382.2	

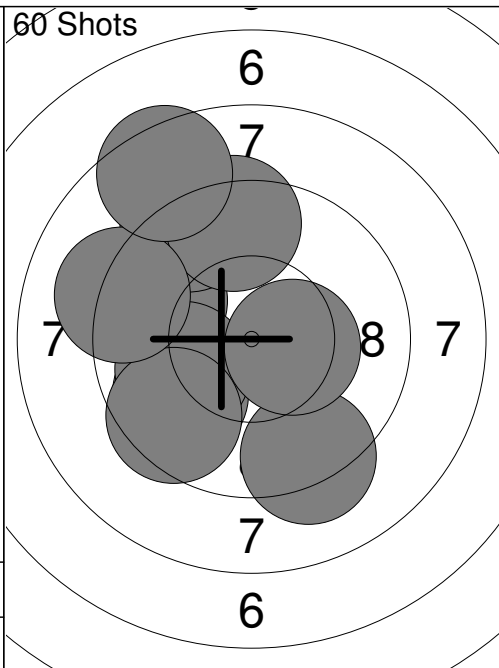

41:	9.6	↖
42:	9.2	↗
43:	9.8	↖
44:	10.0	↖
45:	9.4	↗
46:	9.2	↘
47:	9.5	↖
48:	9.1	←
49:	10.4x	→
50:	8.5	↗
Series	94.7	
	476.9	

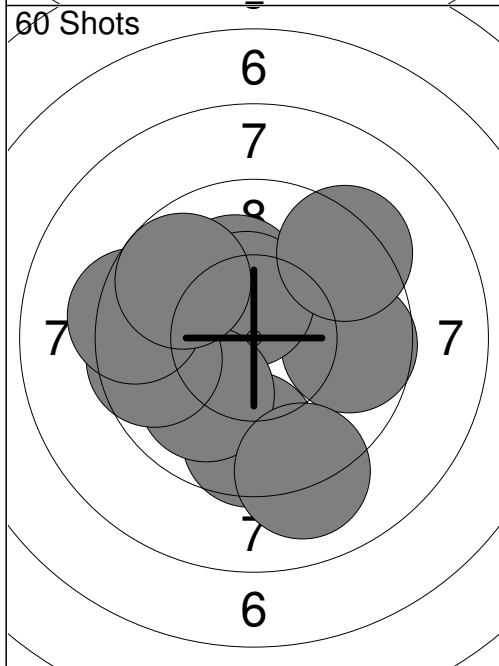

51:	10.2x	↗
52:	9.7	→
53:	9.6	↓
54:	10.4x	↗
55:	10.0	↖
56:	9.6	←
57:	9.3	←
58:	9.1	↓
59:	9.7	↖
60:	9.3	↗
Series	96.9	
	573.8	

--	--

Relay <b>3</b>	Lane <b>8</b>	<b>WANG Borui</b>
-------------------	------------------	-------------------

2023 Western Cdn Air Gur BC	JR	MR
-----------------------------	----	----

14.10.2023	2023 WCAGC Qualifier	Alberta Handgun Association
------------	----------------------	-----------------------------

Comment	Signature
---------	-----------

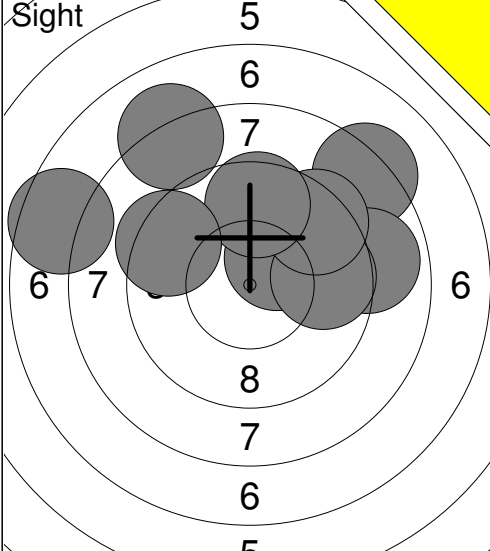
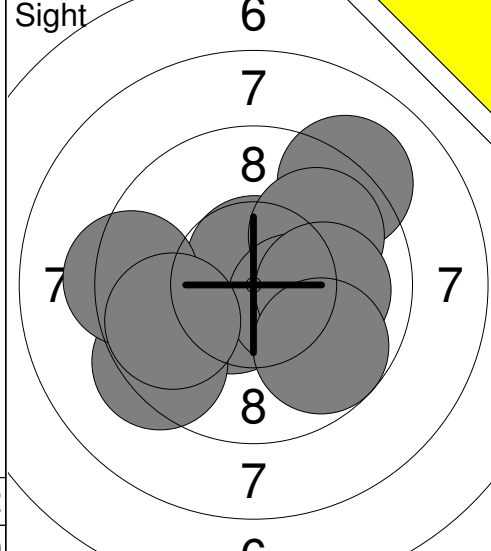
<p>Sight</p>  <p style="text-align: center;">5 6 7 8 7 6 5</p>	<p>1: 8.3 ↗ 2: 10.0 ↗ 3: 8.9 → 4: 8.1 ↖ 5: 10.3x ↗ 6: 9.7 → 7: 9.4 ↗ 8: 9.6 ↑ 9: 9.4 ↖ 10: 7.5 ←</p> <p>Series 91.2 0.0</p>	<p>Sight</p>  <p style="text-align: center;">6 7 8 7 6 5</p>	<p>11: 10.5x ↘ 12: 10.7x ↑ 13: 9.1 ↗ 14: 9.9 ↗ 15: 10.4x → 16: 10.0 → 17: 9.3 ↘ 18: 9.7 ↘ 19: 9.3 ← 20: 9.8 ←</p> <p>Series 98.7 0.0</p>
--	---	--	--

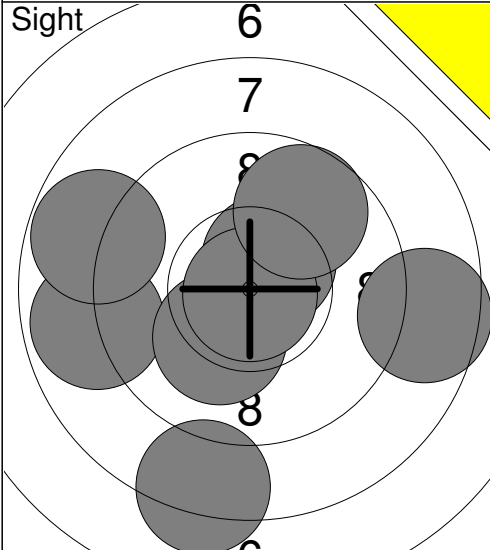
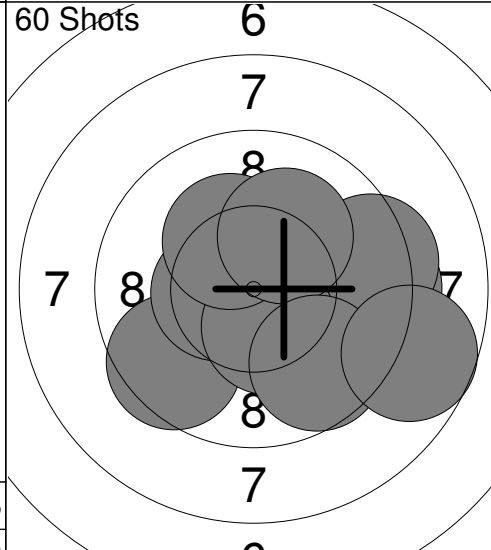
<p>Sight</p>  <p style="text-align: center;">6 7 8 8 7 6</p>	<p>21: 8.6 → 22: 8.2 ↓ 23: 10.5x ↗ 24: 8.9 ← 25: 10.2x ↘ 26: 10.9x ↓ 27: 9.7 ↗ 28: 8.8 ←</p> <p>Series 75.8 0.0</p>	<p>60 Shots</p>  <p style="text-align: center;">6 7 8 7 6</p>	<p>1: 9.4 → 2: 10.4x ↑ 3: 9.4 → 4: 9.5 ↘ 5: 10.5x ← 6: 10.4x ↘ 7: 10.3x ↗ 8: 10.1 ↗ 9: 9.7 ↘ 10: 8.7 →</p> <p>Series 98.4 98.4</p>
---	---	--	--

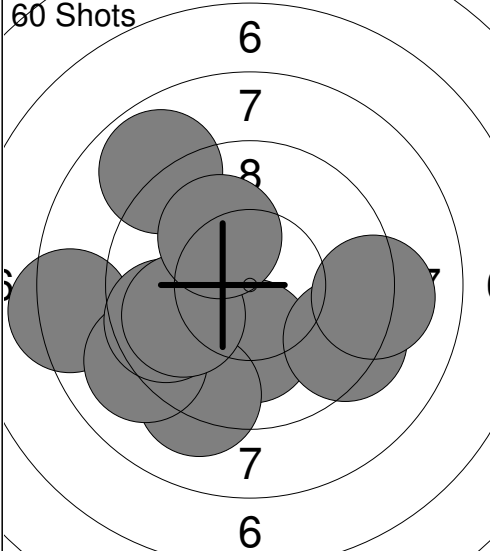
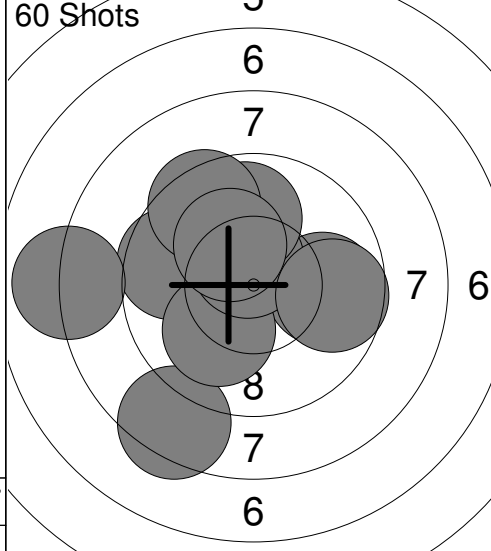
<p>60 Shots</p>  <p style="text-align: center;">6 7 8 7 6</p>	<p>11: 8.9 ↖ 12: 8.3 ← 13: 10.1 ↓ 14: 9.4 → 15: 9.2 ↓ 16: 9.1 ← 17: 9.6 ← 18: 9.1 → 19: 9.9 ← 20: 10.1 ↖</p> <p>Series 93.7 192.1</p>	<p>60 Shots</p>  <p style="text-align: center;">6 7 8 7 6 5</p>	<p>21: 9.6 ← 22: 8.4 ↘ 23: 9.9 → 24: 10.1 ↘ 25: 10.6x ↑ 26: 9.9 ↑ 27: 9.7 → 28: 9.5 ↗ 29: 10.2x ↗ 30: 8.0 ←</p> <p>Series 95.9 288.0</p>
---	---	---	--



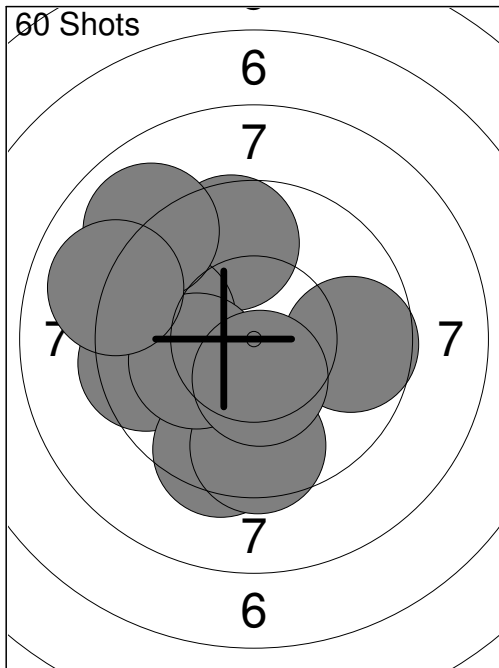

31:	9.6	↑
32:	9.8	←
33:	9.5	←
34:	9.7	→
35:	9.4	↓
36:	9.0	↖
37:	9.5	↓
38:	10.1	←
39:	9.0	←
40:	10.4x	↓
Series	96.0	
	384.0	

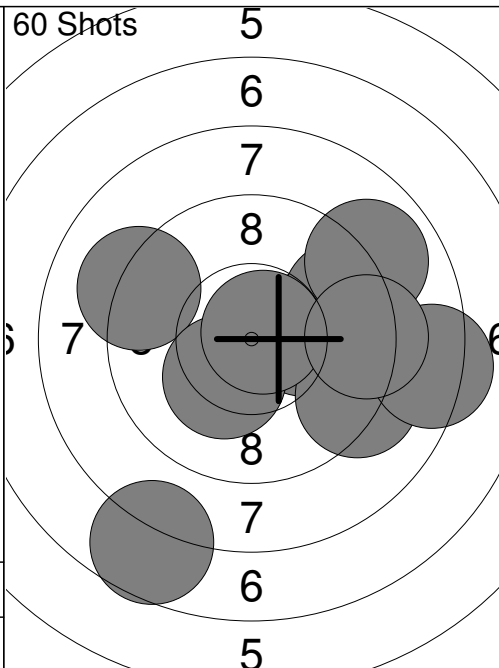

41:	10.2x	→
42:	9.2	↘
43:	8.3	→
44:	9.2	←
45:	9.5	→
46:	10.3x	↙
47:	10.8x	↗
48:	8.9	↗
49:	9.3	→
50:	7.7	↓
Series	93.4	
	477.4	

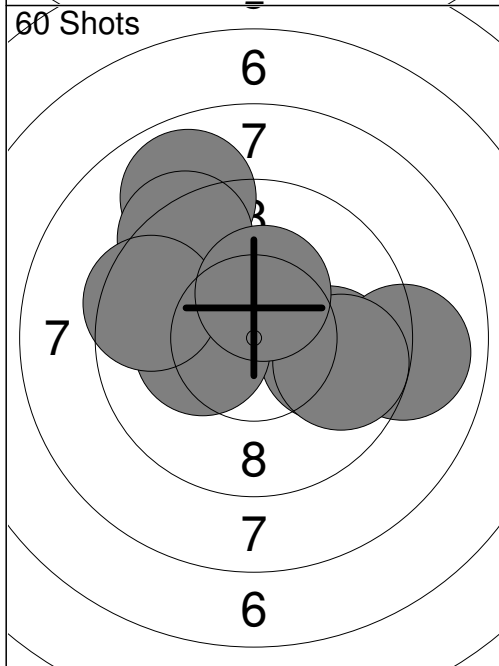

51:	10.3x	↖
52:	10.6x	↗
53:	9.9	→
54:	8.9	↗
55:	9.4	↗
56:	10.3x	←
57:	9.0	→
58:	9.8	→
59:	9.5	←
60:	10.3x	↑
Series	98.0	
	575.4	

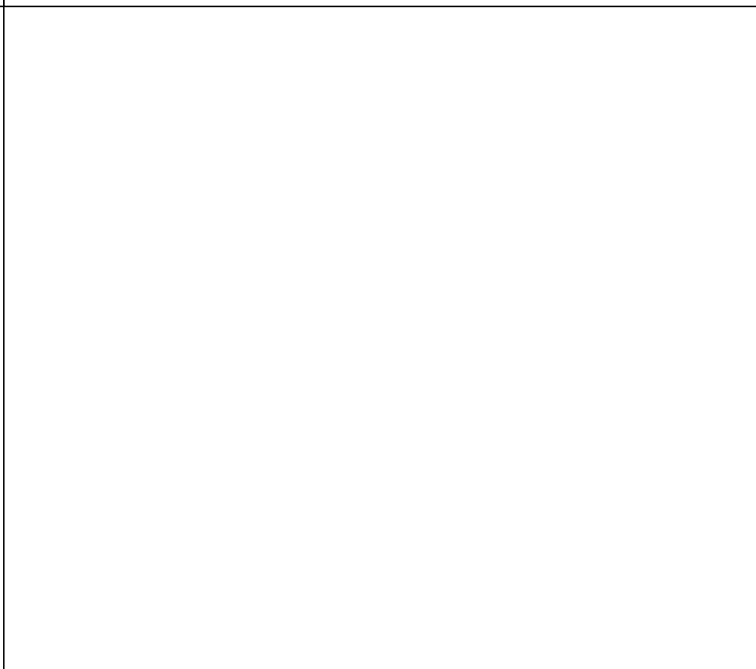
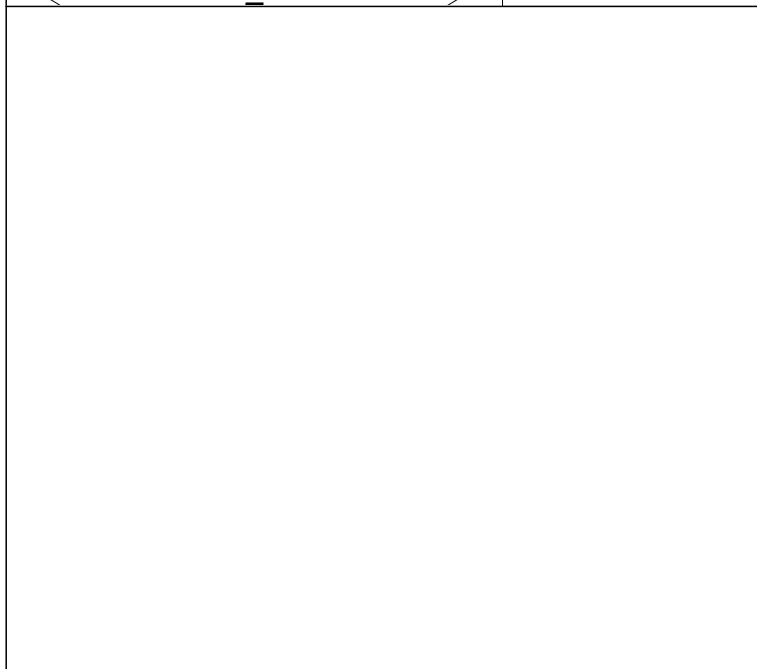

Relay **3** Lane **9** **PAN Mason**

2023 Western Cdn Air Gur BC JR MR

14.10.2023 2023 WCAGC Qualifier Alberta Handgun Association

Comment Signature

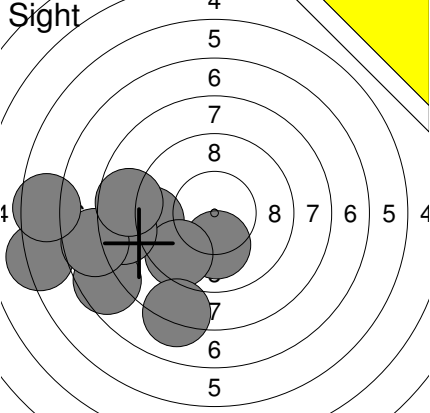
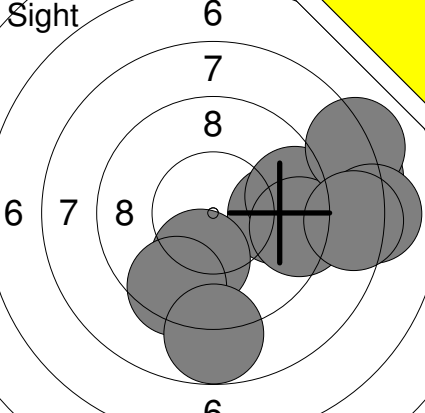
Sight 	1: 6.2 ←	Sight 	11: 9.8 →
	2: 9.2 ←		12: 10.1 ↓
	3: 10.1 ↓		13: 9.5 ↓
	4: 9.5 ↙		14: 8.3 →
	5: 7.6 ↙		15: 8.8 ↓
	6: 8.5 ←		16: 9.5 →
	7: 8.1 ↓		17: 9.4 →
	8: 7.7 ←		18: 8.1 →
	9: 6.5 ←		19: 8.1 →
	10: 8.7 ←		20: 8.4 →
Series	82.1	Series	90.0
	0.0		0.0

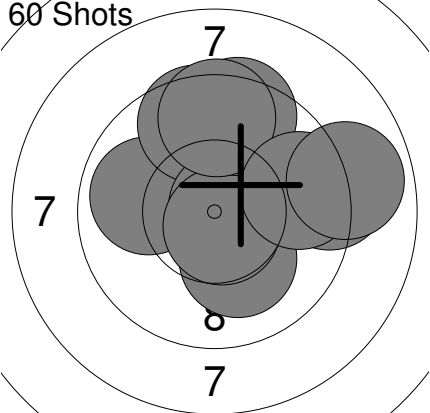
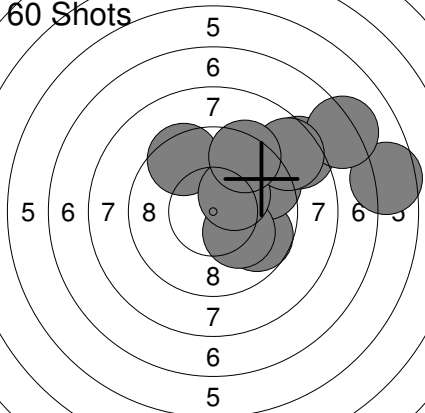
60 Shots 	1: 9.9 ←	60 Shots 	11: 9.7 →
	2: 9.6 ↖		12: 9.5 →
	3: 10.1 ↓		13: 10.1 ↘
	4: 10.7x →		14: 9.5 ↖
	5: 10.7x ↓		15: 6.6 →
	6: 9.2 →		16: 10.3x ↗
	7: 9.4 ↖		17: 8.4 ↗
	8: 9.5 ↖		18: 7.2 ↗
	9: 9.6 →		19: 8.6 ↗
	10: 8.9 →		20: 9.4 ↖
Series	97.6	Series	89.3
	97.6		186.9

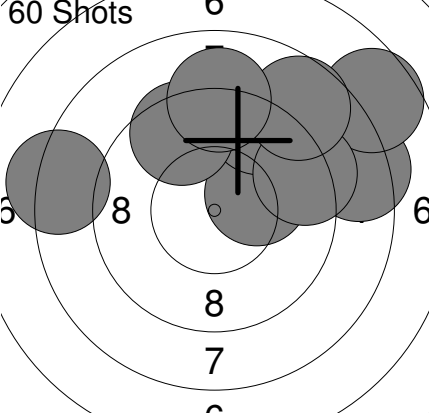
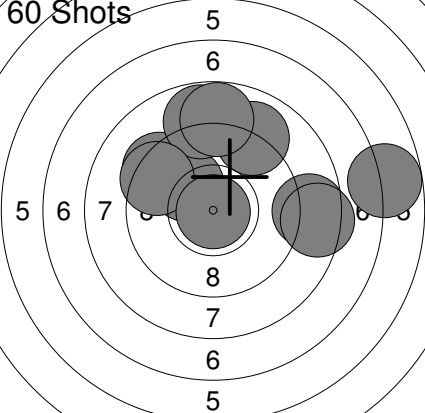
60 Shots 	21: 8.2 ←	60 Shots 	31: 9.0 ↖
	22: 8.4 →		32: 9.3 ↖
	23: 10.2x →		33: 10.1 ↖
	24: 9.2 ↖		34: 8.8 ↖
	25: 9.2 ↖		35: 8.6 →
	26: 7.6 ↗		36: 8.4 →
	27: 9.3 →		37: 9.4 ↖
	28: 9.5 ↖		38: 6.7 →
	29: 8.7 ↗		39: 10.9x ↓
	30: 9.0 ↖		40: 8.8 ↖
Series	89.3	Series	90.0
	276.2		366.2

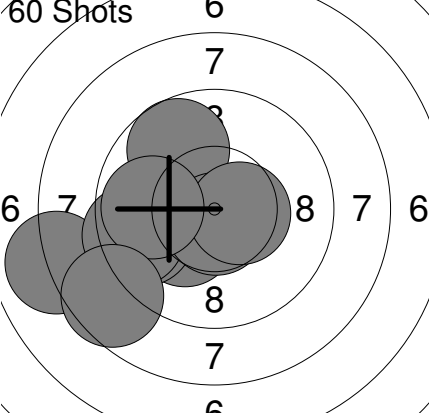
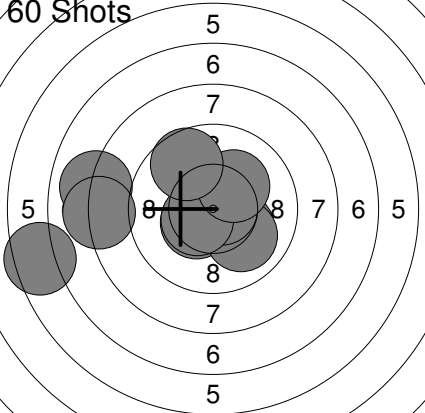
60 Shots 	41: 10.3x ↙	60 Shots 	51: 6.5 ←
	42: 10.4x ←		52: 10.4x ↙
	43: 8.0 ←		53: 10.2x ↘
	44: 9.7 ↖		54: 10.0 ↘
	45: 9.6 ←		55: 10.7x →
	46: 9.4 ←		56: 10.5x ↙
	47: 10.7x ↓		57: 8.0 ←
	48: 10.5x →		58: 10.2x ↗
	49: 9.9 ←		59: 8.1 ←
	50: 8.6 ↙		60: 9.7 ↖
Series	97.1	Series	94.3
	463.3		557.6

Relay **3** Lane **10** **FU Vivian (weimiao)**

2023 Western Cdn Air Gur BC JR WR

14.10.2023 2023 WCAGC Qualifier Alberta Handgun Association

Comment Signature

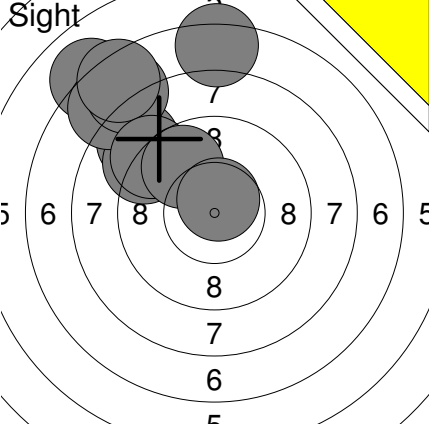
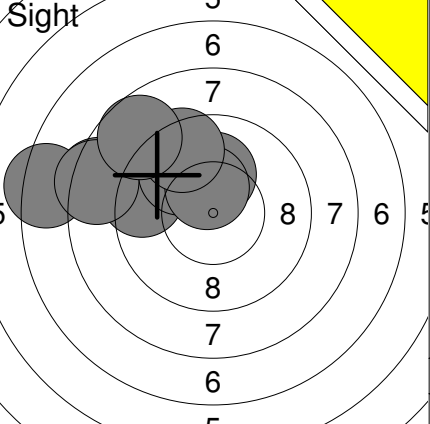
Sight 	1: 8.7 ↗	Sight 	11: 10.1 ↑
	2: 9.1 ↗		12: 8.4 ←
	3: 7.0 ↗		13: 9.4 ←
	4: 7.7 ↗		14: 9.8 ↗
	5: 7.7 ↗		15: 10.4x ↑
	6: 7.4 ↗		16: 9.5 ↗
	7: 9.1 ↗		17: 7.3 ←
	8: 9.7 ↗		18: 8.4 ←
	9: 7.3 ↑		19: 8.7 ↗
	10: 10.6x ↑		
	Series 84.3		Series 82.0
	0.0		0.0

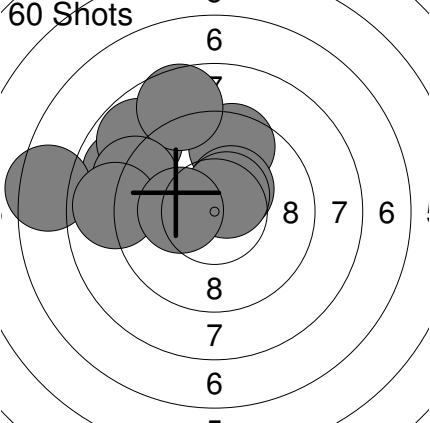
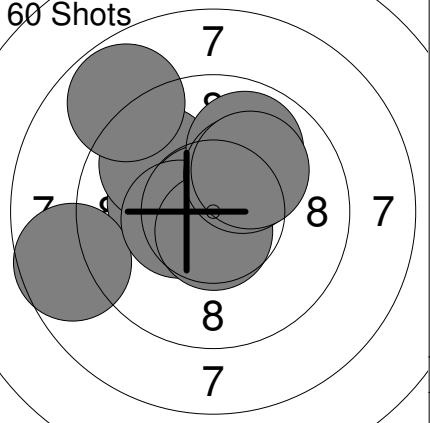
60 Shots 	1: 8.9 ←	60 Shots 	11: 10.2x ←
	2: 8.8 ↗		12: 9.8 ↗
	3: 9.5 ↑		13: 8.7 ←
	4: 10.4x ↗		14: 10.8x ↗
	5: 8.7 ↗		15: 10.4x ←
	6: 10.5x ↗		16: 10.6x ↓
	7: 9.2 ↗		17: 9.9 ↑
	8: 7.4 ←		18: 8.8 ↗
	9: 8.9 ←		19: 10.2x ↗
	10: 10.2x ←		20: 10.1 ↗
	Series 92.5		Series 99.5
	92.5		192.0

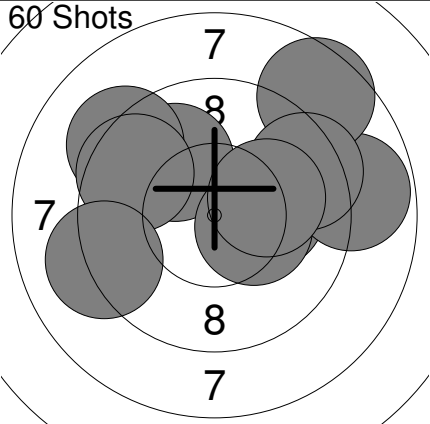
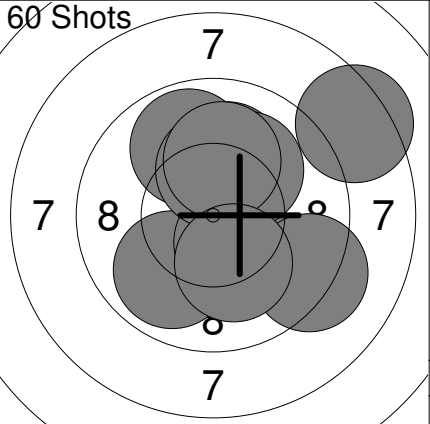
60 Shots 	21: 9.9 ↗	60 Shots 	31: 9.9 ↘
	22: 10.1 →		32: 10.1 ↑
	23: 10.3x →		33: 9.9 ↑
	24: 8.8 →		34: 10.4x ↘
	25: 9.2 ↗		35: 9.2 ↘
	26: 8.6 ↗		36: 8.4 ↗
	27: 9.6 ↗		37: 10.3x ↑
	28: 9.4 →		38: 10.1 ↗
	29: 10.1 →		39: 10.1 ↑
	30: 9.1 ←		40: 10.2x ↓
	Series 95.1		Series 98.6
	287.1		385.7

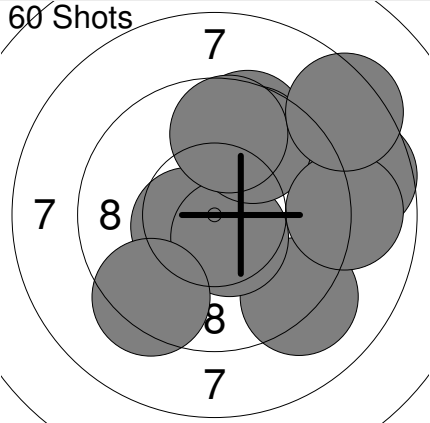
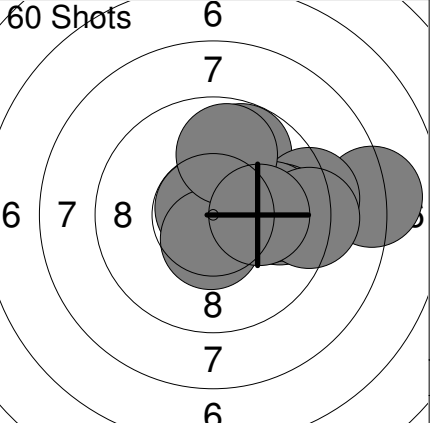
60 Shots 	41: 9.2 ↘	60 Shots 	51: 9.8 ↑
	42: 10.5x ←		52: 8.1 →
	43: 9.5 ↑		53: 9.2 →
	44: 8.7 →		54: 10.8x ↗
	45: 10.5x ↘		55: 9.8 →
	46: 9.4 ↘		56: 9.9 →
	47: 9.7 ↗		57: 9.2 →
	48: 9.0 →		58: 10.5x ↓
	49: 9.7 ↑		59: 9.8 ↑
	50: 8.4 ↗		60: 10.1 →
	Series 94.6		Series 97.2
	480.3		577.5

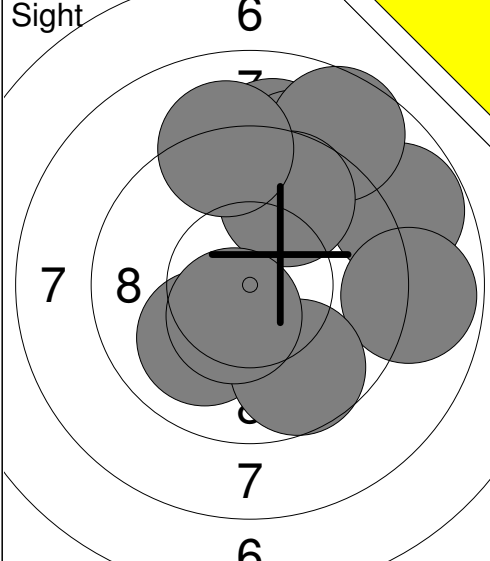
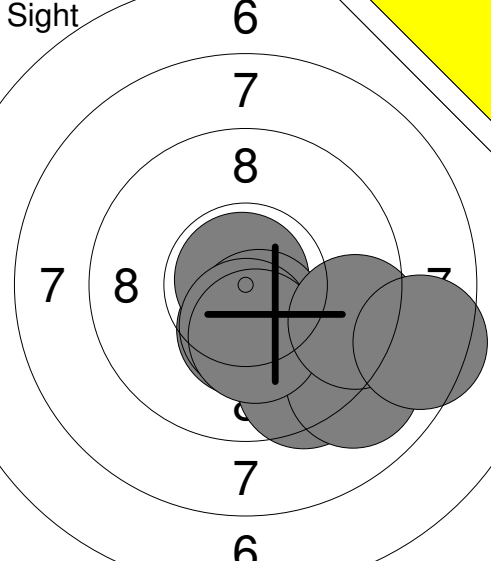
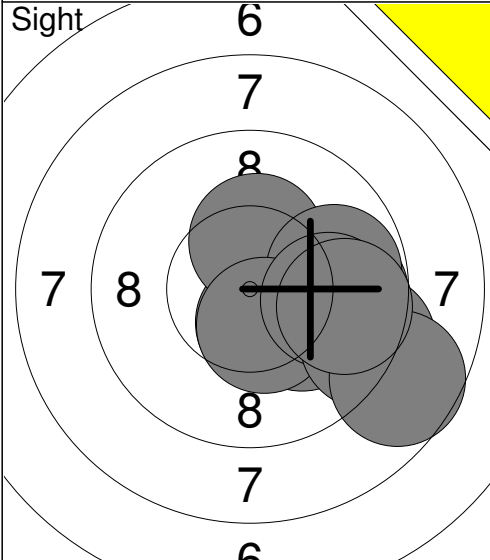
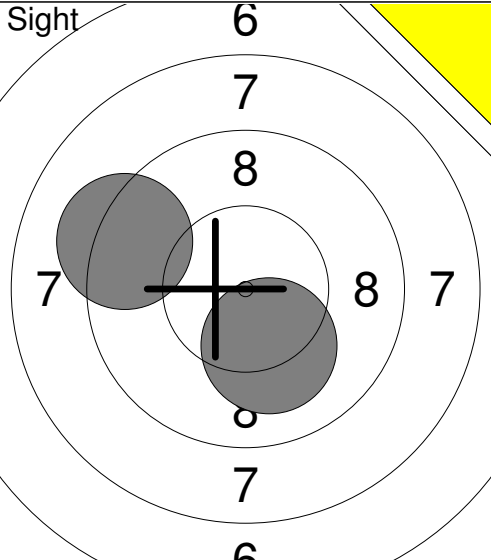
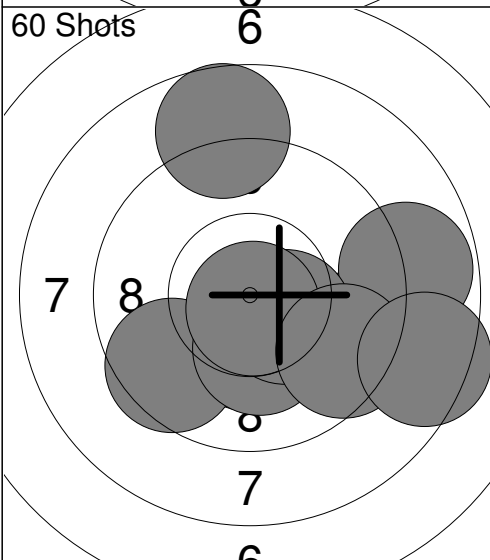
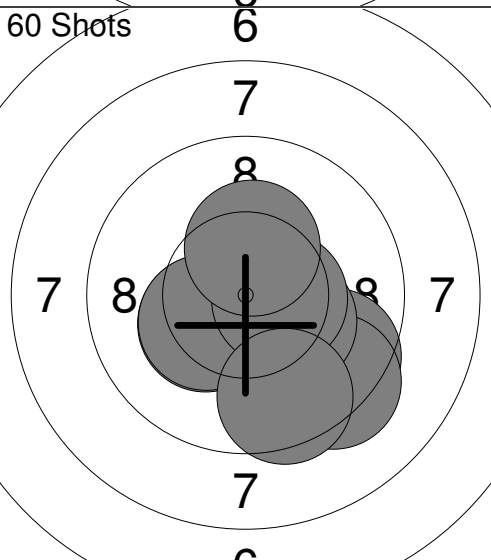
Sight	6	Sight	6
	1: 8.8 → 2: 9.1 ↑ 3: 9.2 ↑ 4: 8.6 ↗ 5: 9.7 ↑ 6: 10.0 ↘ 7: 8.8 → 8: 9.7 ↘ 9: 9.1 ↑ 10: 10.5x ↘ Series 93.5 0.0		11: 9.5 ↘ 12: 10.4x ↘ 13: 10.9x ↗ 14: 10.5x ↘ 15: 9.4 ↘ 16: 10.4x ↘ 17: 9.0 ↘ 18: 10.3x ↘ 19: 9.4 → 20: 8.5 → Series 98.3 0.0
Sight	6	Sight	6
	21: 10.1 ↘ 22: 9.7 → 23: 10.5x ↘ 24: 10.3x ↑ 25: 9.8 → 26: 10.4x ↘ 27: 9.9 → 28: 9.2 ↘ 29: 8.7 ↘ 30: 9.7 → Series 98.3 0.0		31: 9.2 ↖ 32: 10.1 ↘ Series 19.3 0.0
60 Shots	6	60 Shots	6
	1: 9.5 → 2: 10.3x ↘ 3: 9.5 ↘ 4: 8.8 → 5: 10.2x ↘ 6: 10.4x ↘ 7: 8.7 ↑ 8: 10.8x ↘ 9: 9.5 ↘ 10: 8.4 → Series 96.1 96.1		11: 10.3x ↖ 12: 10.8x ↗ 13: 9.5 ↘ 14: 9.3 ↘ 15: 10.5x ↘ 16: 10.3x ↘ 17: 10.3x ↖ 18: 10.5x → 19: 9.5 ↘ 20: 10.3x ↑ Series 101.3 197.4

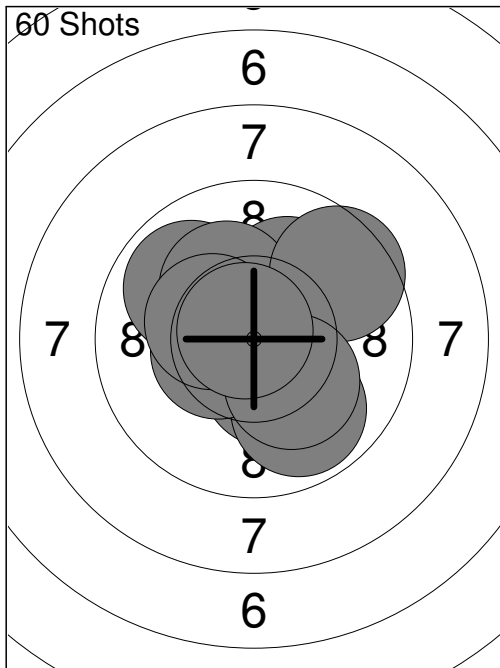

21:	9.9	↗
22:	10.4x	↘
23:	9.9	↘
24:	10.4x	↙
25:	10.1	↗
26:	10.2x	↗
27:	9.6	↗
28:	10.4x	↙
29:	10.2x	↘
30:	10.8x	↗
Series	101.9	
	299.3	

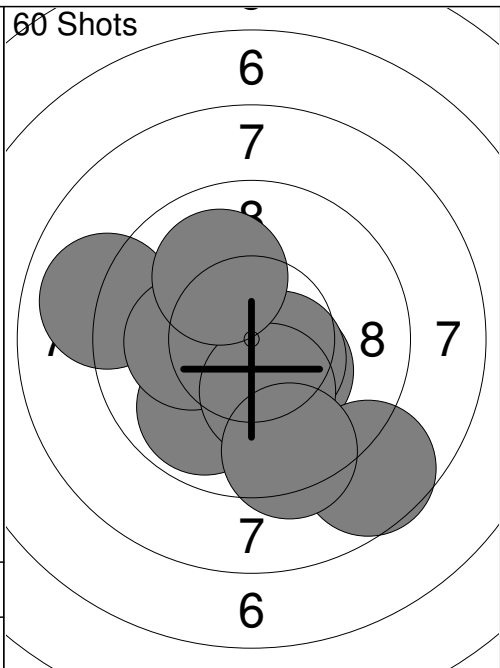

31:	10.6x	↙
32:	10.3x	↘
33:	9.0	↙
34:	9.9	↘
35:	10.5x	↘
36:	8.6	↘
37:	10.2x	↙
38:	10.2x	↘
39:	9.4	↘
40:	10.0	↗
Series	98.7	
	398.0	

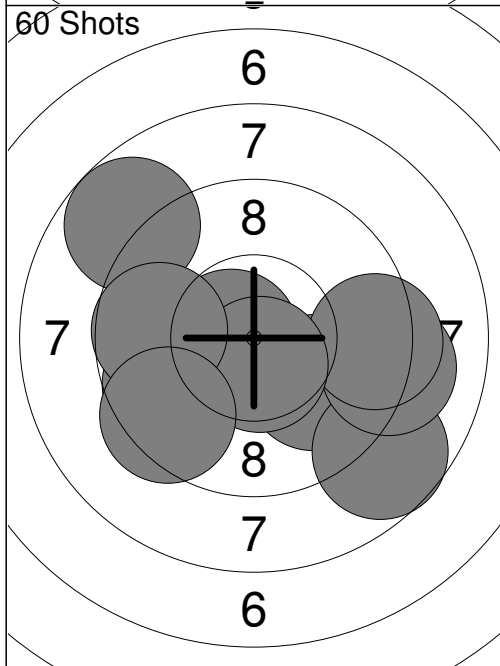

41:	10.0	↘
42:	9.7	↙
43:	10.7x	↙
44:	8.7	↘
45:	9.1	→
46:	9.3	→
47:	10.6x	↘
48:	8.8	↗
49:	9.7	↙
50:	9.4	↘
Series	96.0	
	494.0	

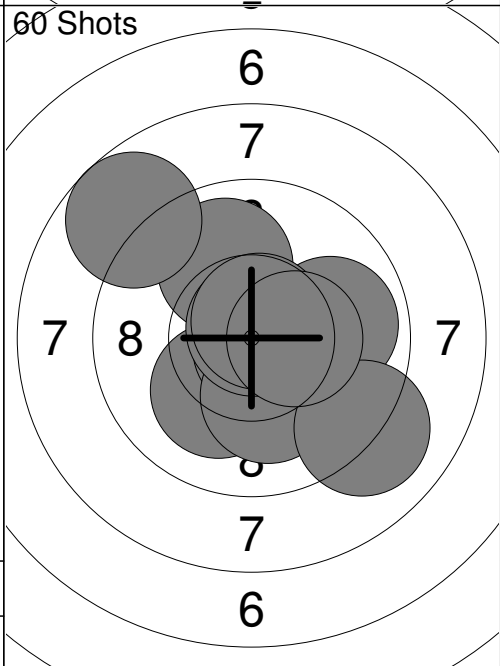

51:	9.9	→
52:	10.1	↘
53:	10.8x	↘
54:	9.9	↗
55:	10.2x	↘
56:	10.8x	↗
57:	9.1	↘
58:	10.7x	↗
59:	10.4x	→
60:	8.7	↘
Series	100.6	
	594.6	

Relay <b>3</b>	Lane <b>12</b>	<b>FAN Wenlan</b>
-------------------	-------------------	-------------------

2023 Western Cdn Air Gur BC	JR	WR
-----------------------------	----	----

14.10.2023	2023 WCAGC Qualifier	Alberta Handgun Association
------------	----------------------	-----------------------------

Comment	Signature
---------	-----------

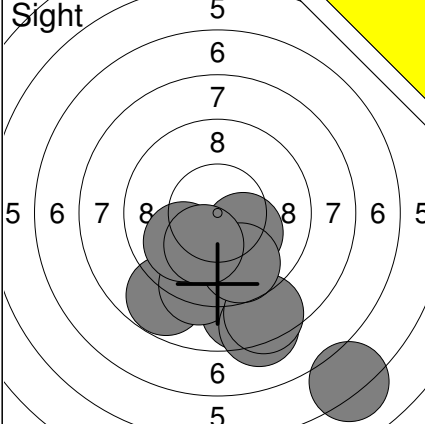
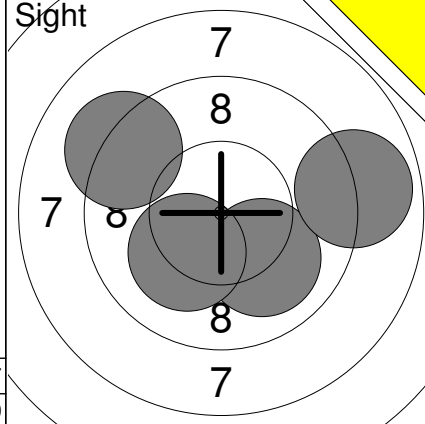
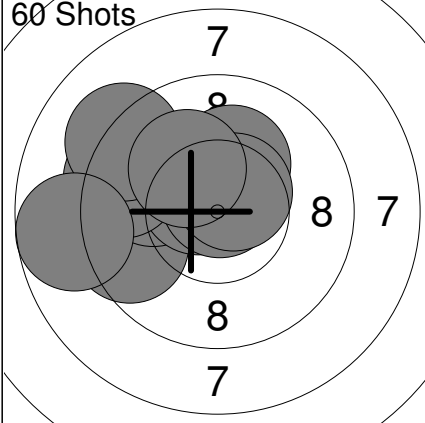
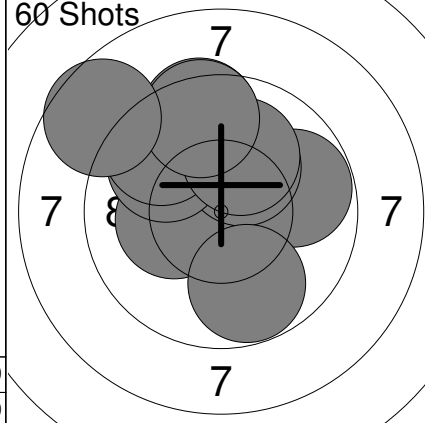
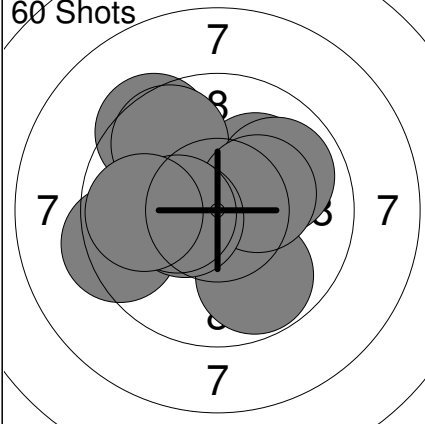
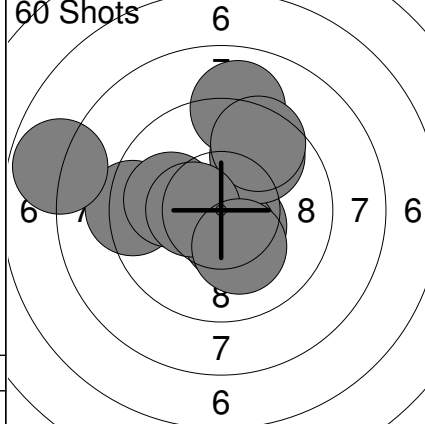
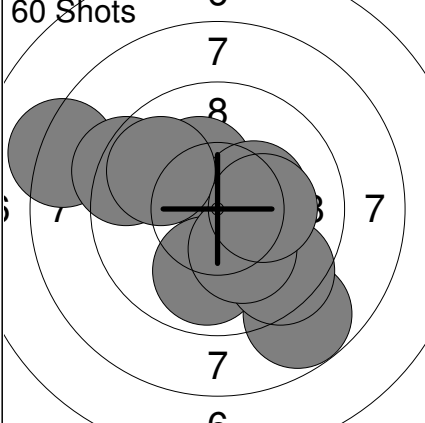
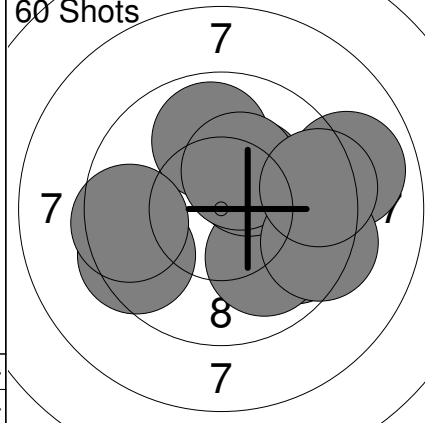
<p>Sight</p> 	<p>1: 6.1 ↓</p> <p>2: 8.8 ↓</p> <p>3: 8.7 ↓</p> <p>4: 9.3 ↓</p> <p>5: 8.2 ↓</p> <p>6: 8.5 ↓</p> <p>7: 10.2x ↓</p> <p>8: 10.0 ←</p> <p>9: 9.7 ↓</p> <p>10: 10.2x ↓</p> <hr/> <p>Series 89.7</p> <p>0.0</p>	<p>Sight</p> 	<p>11: 10.0 ↓</p> <p>12: 10.1 ↓</p> <p>13: 9.2 ↗</p> <p>14: 8.9 →</p> <hr/> <p>Series 38.2</p> <p>0.0</p>
<p>60 Shots</p> 	<p>1: 9.5 ←</p> <p>2: 9.9 ←</p> <p>3: 10.6x ↗</p> <p>4: 10.7x ↗</p> <p>5: 9.4 ←</p> <p>6: 10.2x ↗</p> <p>7: 9.2 ↗</p> <p>8: 8.7 ←</p> <p>9: 10.6x ↗</p> <p>10: 10.1 ↗</p> <hr/> <p>Series 98.9</p> <p>98.9</p>	<p>60 Shots</p> 	<p>11: 10.2x ←</p> <p>12: 9.8 →</p> <p>13: 10.2x ↗</p> <p>14: 9.8 ↗</p> <p>15: 9.5 ↗</p> <p>16: 9.8 ↓</p> <p>17: 9.6 ↗</p> <p>18: 10.1 ↗</p> <p>19: 9.5 ↗</p> <p>20: 8.6 ↘</p> <hr/> <p>Series 97.1</p> <p>196.0</p>
<p>60 Shots</p> 	<p>21: 9.4 ↗</p> <p>22: 10.1 ↗</p> <p>23: 9.8 ↓</p> <p>24: 9.7 ↗</p> <p>25: 9.9 →</p> <p>26: 9.4 ←</p> <p>27: 10.3x →</p> <p>28: 10.4x ←</p> <p>29: 10.3x ←</p> <p>30: 9.8 ←</p> <hr/> <p>Series 99.1</p> <p>295.1</p>	<p>60 Shots</p> 	<p>31: 9.0 ↑</p> <p>32: 10.5x ↓</p> <p>33: 10.5x ↓</p> <p>34: 9.3 ←</p> <p>35: 10.0 ←</p> <p>36: 9.7 ↗</p> <p>37: 9.5 ↗</p> <p>38: 7.8 ←</p> <p>39: 10.4x ←</p> <p>40: 10.2x ↓</p> <hr/> <p>Series 96.9</p> <p>392.0</p>
<p>60 Shots</p> 	<p>41: 10.2x ↗</p> <p>42: 8.2 ↗</p> <p>43: 8.8 ↓</p> <p>44: 9.9 ↓</p> <p>45: 9.5 ↓</p> <p>46: 9.3 ↗</p> <p>47: 10.3x →</p> <p>48: 10.2x ↓</p> <p>49: 9.8 ↗</p> <p>50: 10.2x →</p> <hr/> <p>Series 96.4</p> <p>488.4</p>	<p>60 Shots</p> 	<p>51: 9.9 ↑</p> <p>52: 9.5 ←</p> <p>53: 9.7 →</p> <p>54: 9.5 ←</p> <p>55: 8.9 →</p> <p>56: 10.0 ↓</p> <p>57: 10.3x ↗</p> <p>58: 10.3x ↗</p> <p>59: 9.4 →</p> <p>60: 9.4 →</p> <hr/> <p>Series 96.9</p> <p>585.3</p>