

Relay 1	Lane 8	<h1 style="margin:0;">KNAUS Gordon</h1>
-------------------	------------------	-----------------------------------------

AHA Provincials	AB	SR	MP
-----------------	----	----	----

06.06.2026	2026 AB ISSF RF S1	Alberta Handgun Association
------------	--------------------	-----------------------------

Comment	Signature
---------	-----------

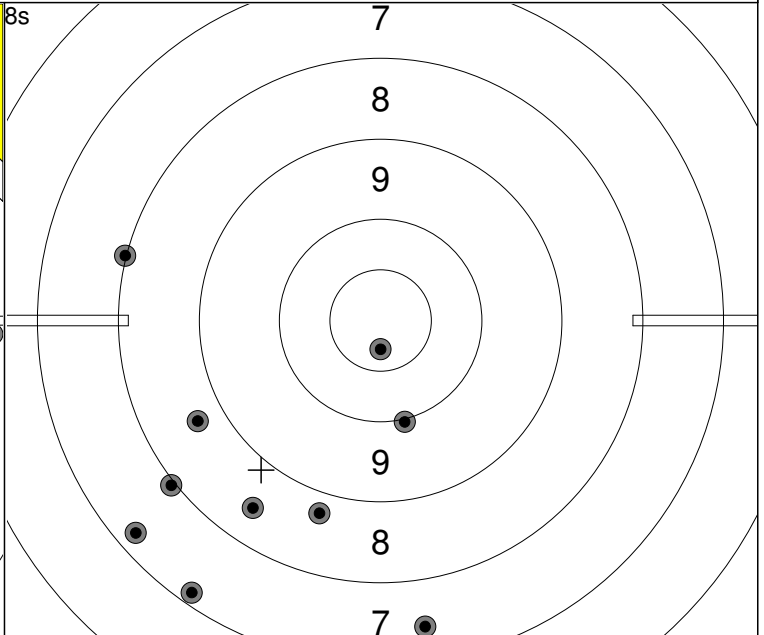
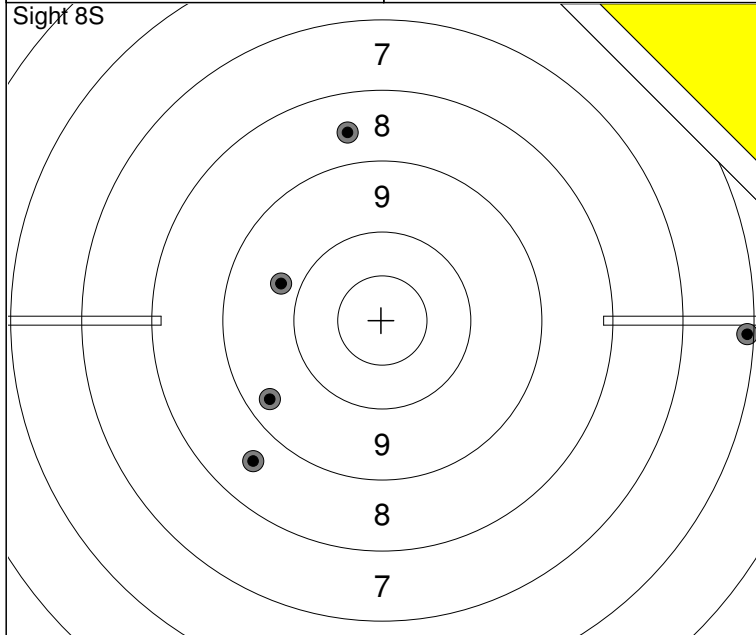

5: 2.14s 9.7 ↖
4: 3.23s 8.6 ↑
3: 4.24s 8.6 ↘
2: 5.18s 6.1 →
1: 6.29s 9.3 ↙

Series 40 (0x)
0 (0x)

5: 1.71s 7.4 ↓
4: 2.72s 8.8 ↓
3: 3.67s 7.2 ↘
2: 4.86s 8.5 ↘
1: 5.93s 8.0 ↙

5: 2.02s 10.7x ↓
4: 3.07s 8.7 ↙
3: 4.12s 8.0 ↙
2: 5.29s 7.3 ↙
1: 6.37s 10.0 ↓

Series 81 (1x)
81 (1x)

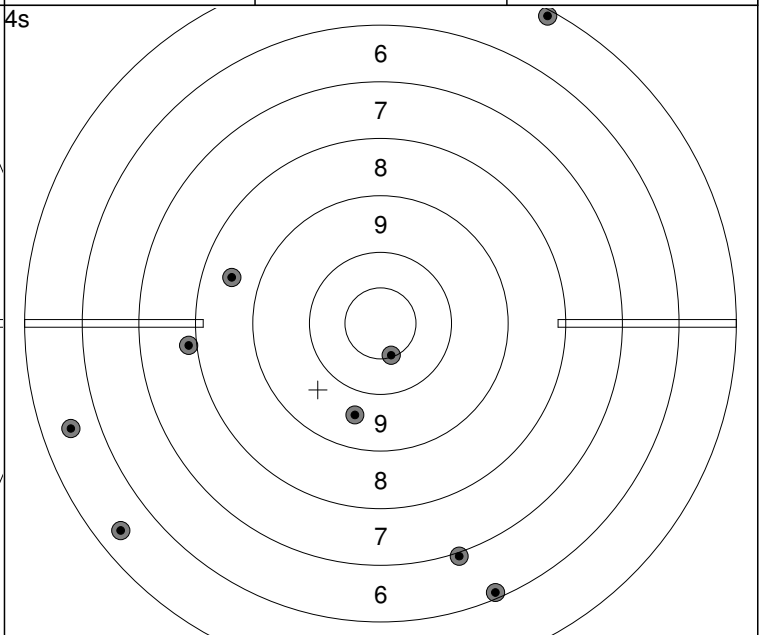
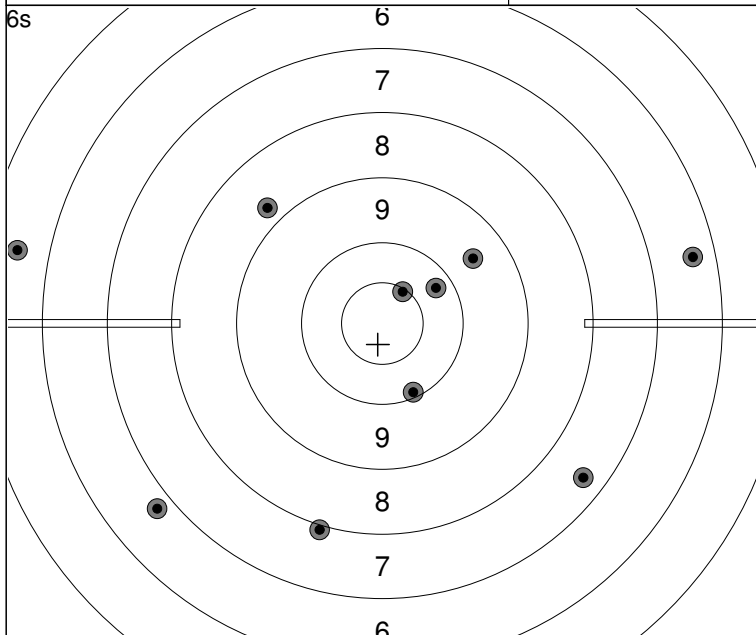

5: 1.87s 7.4 ↘
4: 2.68s 10.5x ↗
3: 3.41s 6.4 →
2: 4.32s 7.9 ↓
1: 5.25s 6.8 ↙

5: 2.07s 5.5 ↙
4: 2.98s 8.8 ↙
3: 3.81s 10.2 ↗
2: 4.82s 9.5 ↗
1: 5.55s 10.1 ↓

Series 78 (1x)
159 (2x)

5: 1.61s 5.1 ↗
3: 2.60s 5.5 ↙
2: 3.04s 7.0 ↓
1: 3.56s 5.4 ↙
4: --

5: 1.48s 6.1 ↓
4: 2.15s 8.5 ↙
3: 2.75s 9.6 ↓
2: 3.37s 10.5x ↓
1: 3.91s 7.9 ↙

Series 62 (1x)
221 (3x)

Relay 1	Lane 13	DJAJA Yeremia
-------------------	-------------------	----------------------

AHA Provincials	AB	SR	MP
-----------------	----	----	----

06.06.2026	2026 AB ISSF RF S1	Alberta Handgun Association
------------	--------------------	-----------------------------

Comment	Signature
---------	-----------

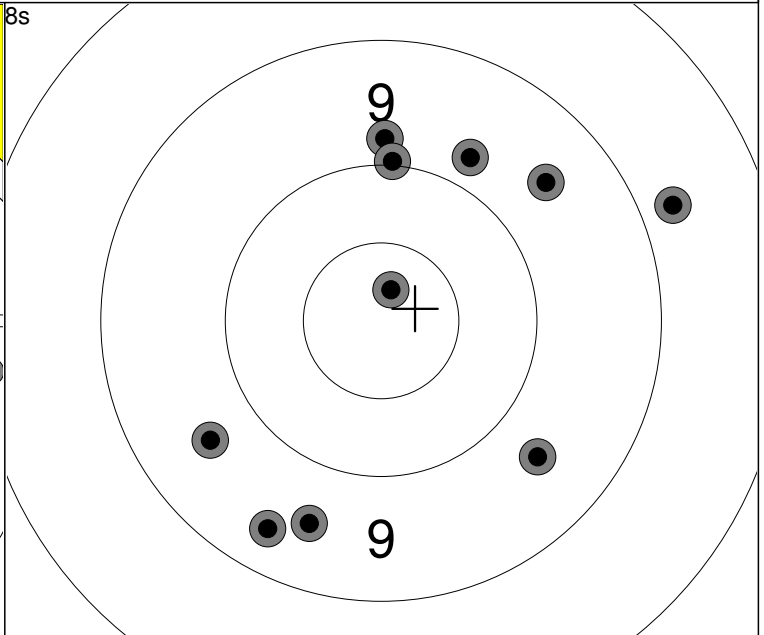
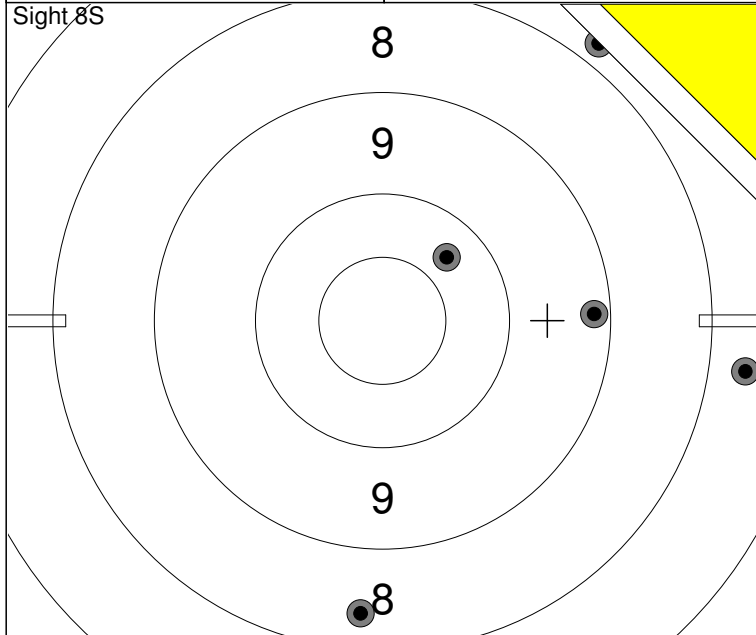

5: 1.67s 10.3 ↗
4: 3.57s 7.7 →
3: 4.66s 9.2 →
2: 6.16s 8.4 ↓
1: 7.12s 7.8 ↗

Series	41 (0x)
	0 (0x)

5: 1.87s 9.5 ↗
4: 2.87s 9.4 ↓
3: 3.92s 9.8 ↗
2: 4.97s 10.8x ↑
1: 5.97s 9.6 ↘

5: 1.74s 9.8 ↑
4: 2.96s 9.5 ↓
3: 3.98s 8.8 →
2: 5.34s 9.6 ↙
1: 7.01s 10.0 ↑

Series	91 (1x)
	91 (1x)

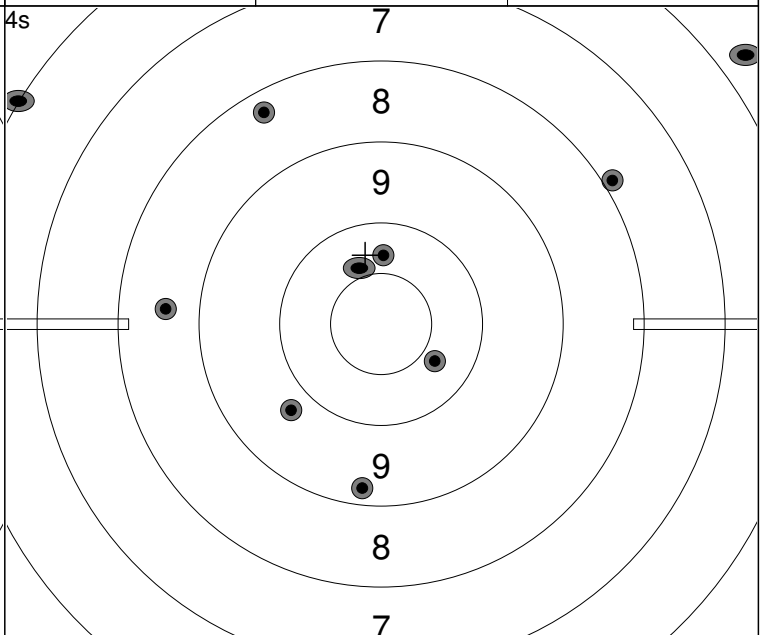
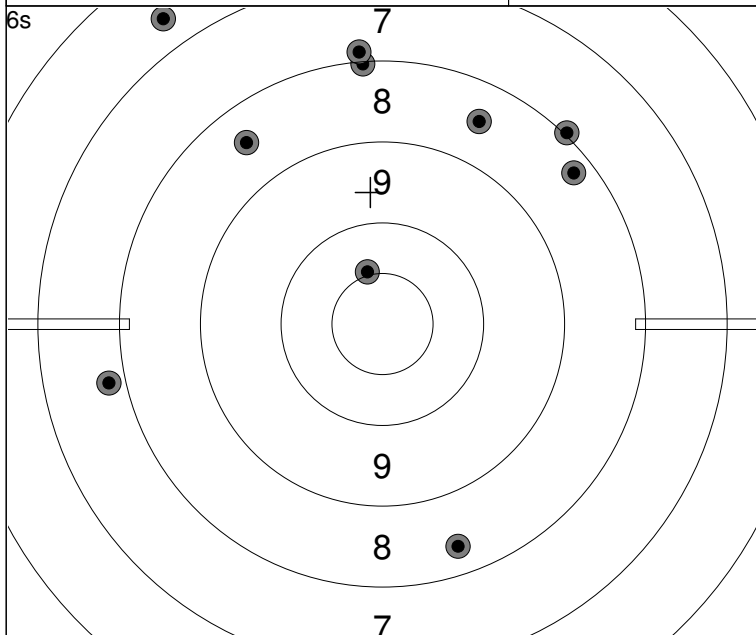

5: 1.71s 8.4 ↓
4: 2.69s 6.6 ↗
3: 3.68s 8.5 ↗
2: 4.52s 8.1 ↑
1: 5.66s 8.5 ↗

5: 2.11s 7.9 ↑
4: 2.89s 7.8 ←
3: 3.77s 8.0 ↗
2: 4.60s 10.4x ↑
1: 5.46s 8.3 ↗

Series	78 (1x)
	169 (2x)

5: 1.87s 9.2 ↓
4: 2.76s 8.6 ←
3: 3.47s 10.3 ↘
2: 0.04s ↕
1: 0.92s ↕

5: 1.51s 7.9 ↗
4: 2.37s 9.7 ↙
3: 3.22s 8.3 ↗
2: 3.97s 10.3 ↑
1: 0.42s ↕

Series	61 (0x)
	230 (2x)

Relay 1	Lane 18	MARKEWICZ Alan
-------------------	-------------------	-----------------------

AHA Provincials	AB	SR	MP
-----------------	----	----	----

06.06.2026	2026 AB ISSF RF S1	Alberta Handgun Association
------------	--------------------	-----------------------------

Comment	Signature
---------	-----------

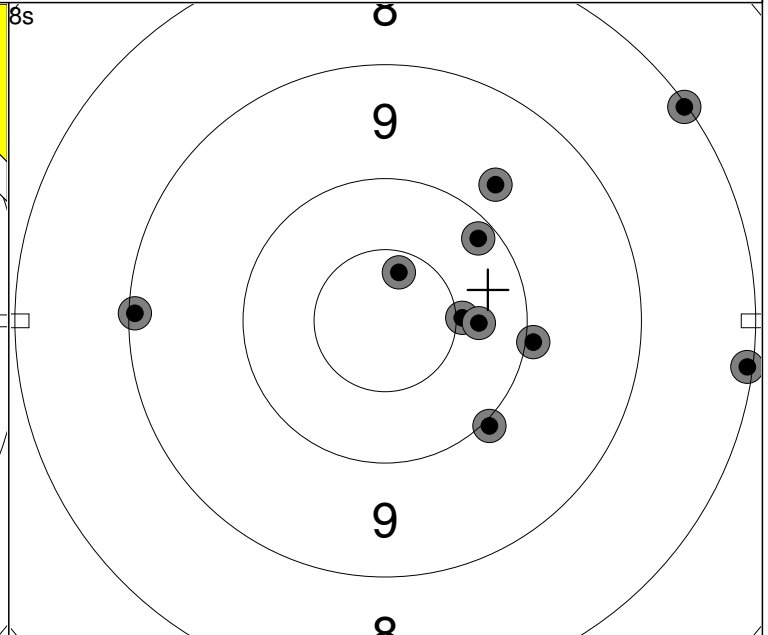
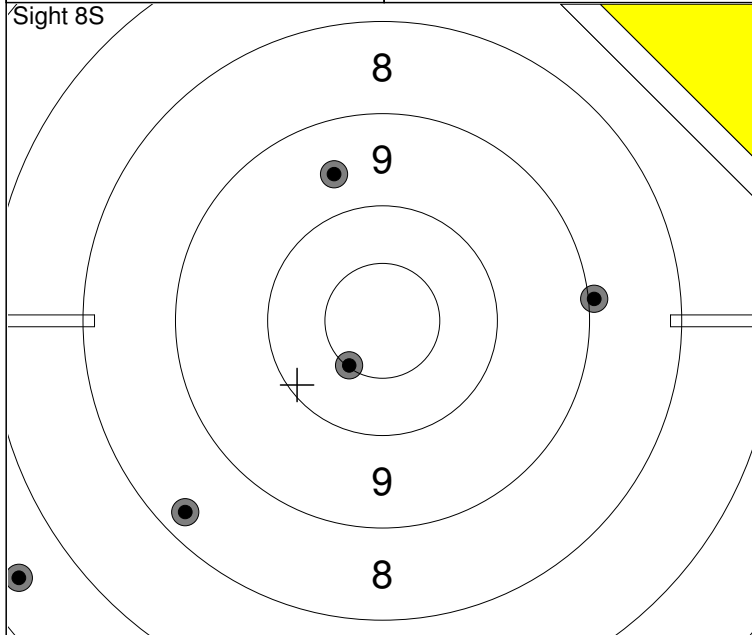

5: 2.69s 9.6 ↗
4: 3.77s 6.4 ↙
3: 4.76s 9.0 →
2: 5.82s 10.5x ↘
1: 6.83s 8.3 ↙

Series	42 (1x)
	0 (0x)

5: 2.36s 8.1 →
4: 3.31s 9.7 ↗
3: 4.33s 10.1 ↗
2: 5.36s 8.0 ↗
1: 6.43s 10.0 ↘

5: 2.39s 10.0 →
4: 3.38s 9.1 ←
3: 4.33s 10.4x →
2: 5.37s 10.6x ↗
1: 6.33s 10.3 →

Series	94 (2x)
	94 (2x)

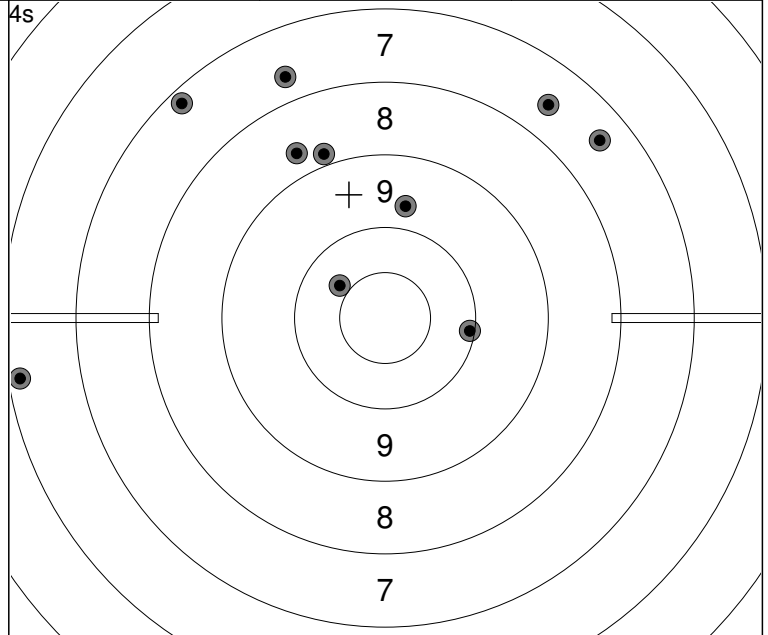
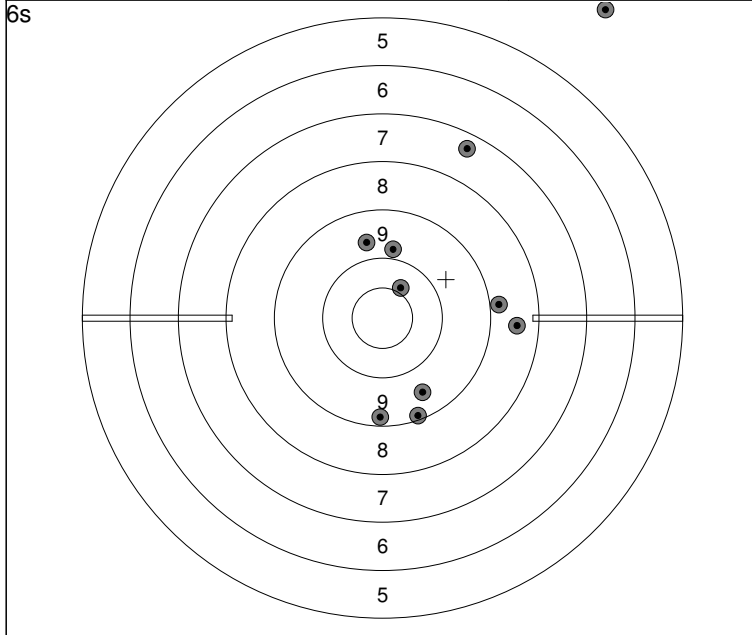

5: 2.20s 0.0 ↗
4: 3.17s 9.2 ↓
3: 4.06s 9.7 ↗
2: 4.95s 8.8 →
1: 5.78s 9.5 ↘

5: 2.07s 7.3 ↗
4: 2.88s 9.8 ↗
3: 3.67s 10.4 ↗
2: 4.50s 9.1 ↘
1: 5.40s 8.5 →

Series	78 (0x)
	172 (2x)

5: 1.63s 9.7 ↗
4: 2.28s 7.7 ↗
3: 2.89s 8.9 ↗
2: 3.50s 10.4 ↘
1: 4.08s 8.7 ↗

5: 1.82s 7.6 ↗
4: 2.46s 6.2 ←
3: 2.99s 7.4 ↗
2: 3.58s 7.2 ↗
1: 4.10s 10.1 →

Series	79 (0x)
	251 (2x)

Relay 2	Lane 8	WICK Werner
-------------------	------------------	--------------------

AHA Provincials	AB	SR	MP
-----------------	----	----	----

06.06.2026	2026 AB ISSF RF S1	Alberta Handgun Association
------------	--------------------	-----------------------------

Comment	Signature
---------	-----------

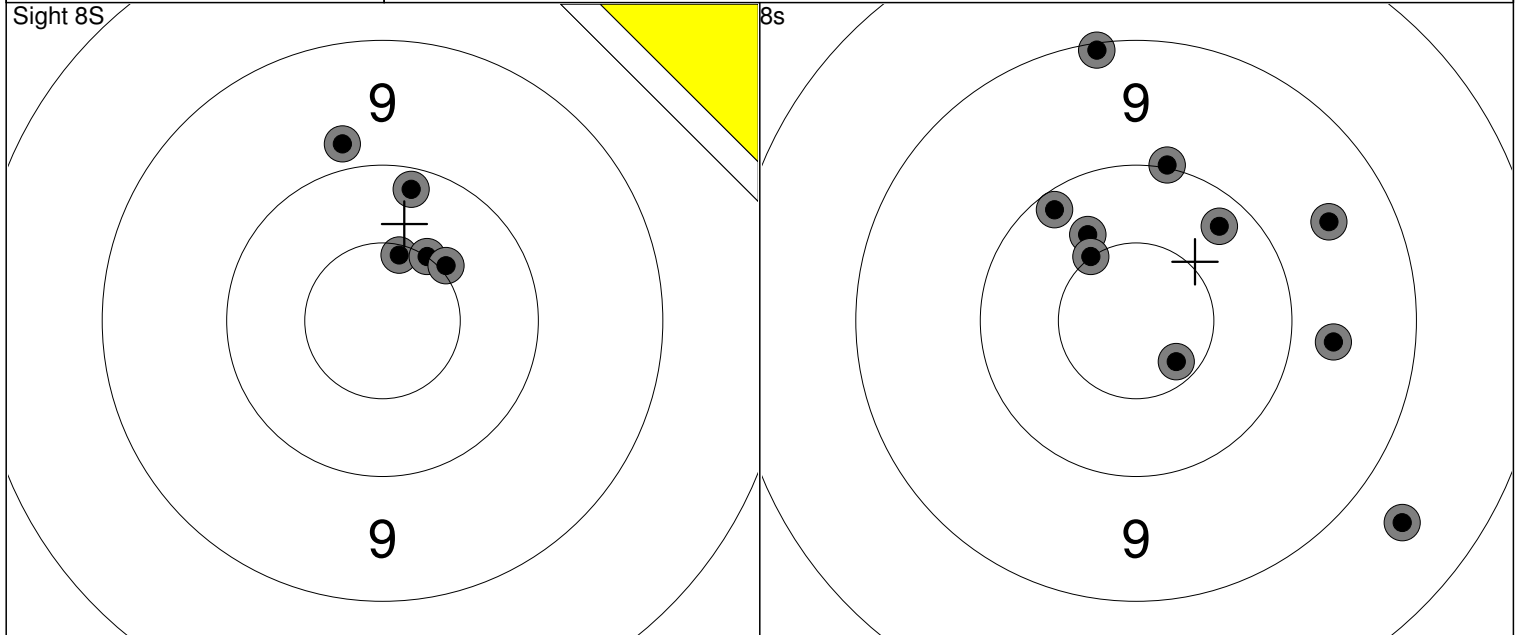

5: 2.25s 9.8 ↑ 4: 3.46s 10.5x ↑ 3: 4.68s 10.5x ↗ 2: 5.67s 10.4x ↗ 1: 6.82s 10.1 ↑	Series 49 (3x) 0 (0x)	5: 2.30s 10.6x ↘ 4: 3.55s 10.2 ↗ 3: 4.64s 9.1 ↑ 2: 5.67s 10.0 ↑ 1: 6.78s 10.3 ↖	Series 95 (2x) 95 (2x)
-----------------------------------------------------------------------------------------------	------------------------------	---------------------------------------------------------------------------------------------	-------------------------------

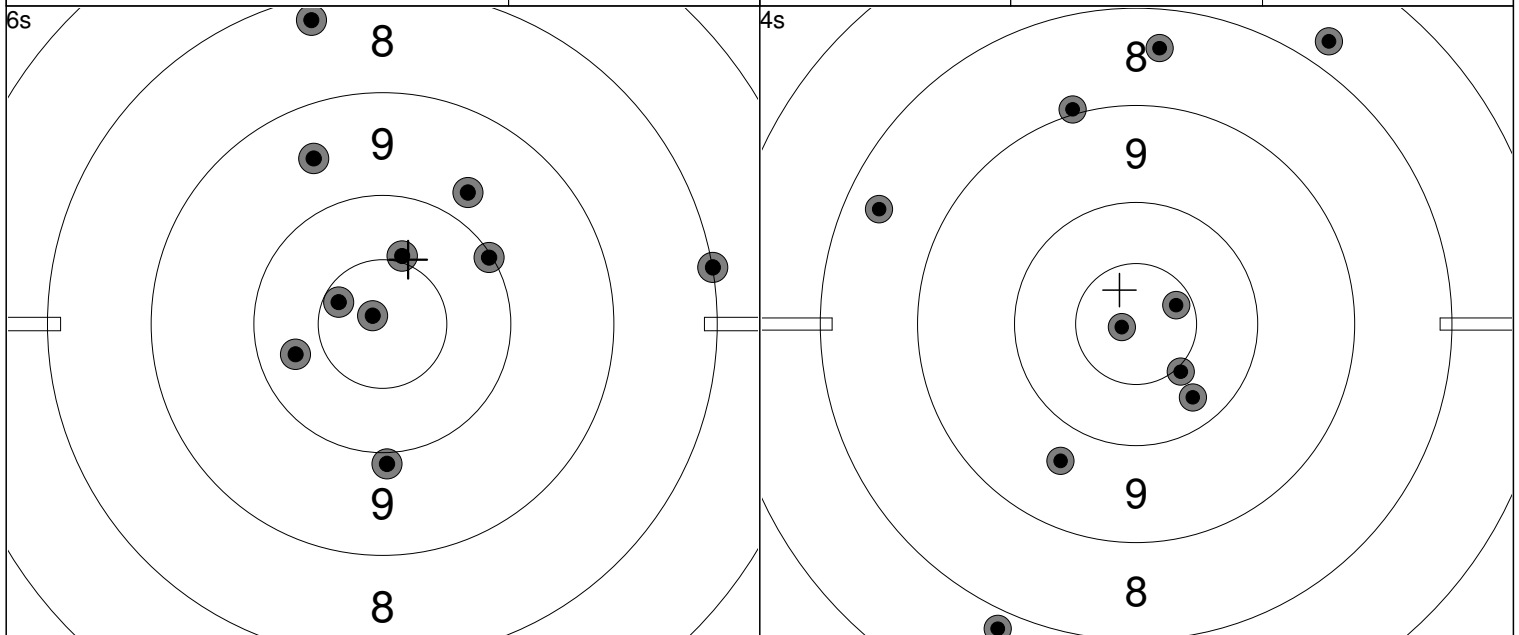

5: 1.98s 8.0 → 4: 2.99s 8.2 ↑ 3: 3.80s 10.0 ↗ 2: 4.60s 9.7 ↗ 1: 5.45s 9.5 ↖	5: 2.10s 10.3 ← 4: 3.03s 10.9x ↖ 3: 3.81s 10.6x ↖ 2: 4.70s 9.9 ↓ 1: 5.49s 10.4x ↑	Series 93 (3x) 188 (5x)	5: 1.81s 10.6x ↗ 4: 2.30s 9.0 ↑ 3: 2.79s 8.4 ↑ 2: 3.26s 8.4 ↖ 1: 3.88s 7.8 ↘	Series 88 (3x) 276 (8x)
-----------------------------------------------------------------------------------------	-----------------------------------------------------------------------------------------------	--------------------------------	------------------------------------------------------------------------------------------	--------------------------------

Relay 2	Lane 13	OLSEN Jesse
-------------------	-------------------	--------------------

AHA Provincials	SK	SR	MP
-----------------	----	----	----

06.06.2026	2026 AB ISSF RF S1	Alberta Handgun Association
------------	--------------------	-----------------------------

Comment	Signature
---------	-----------

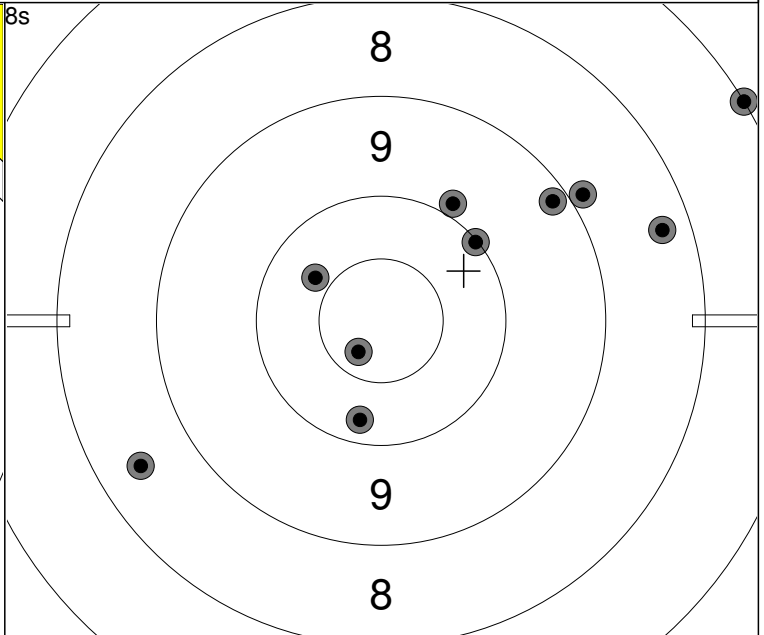
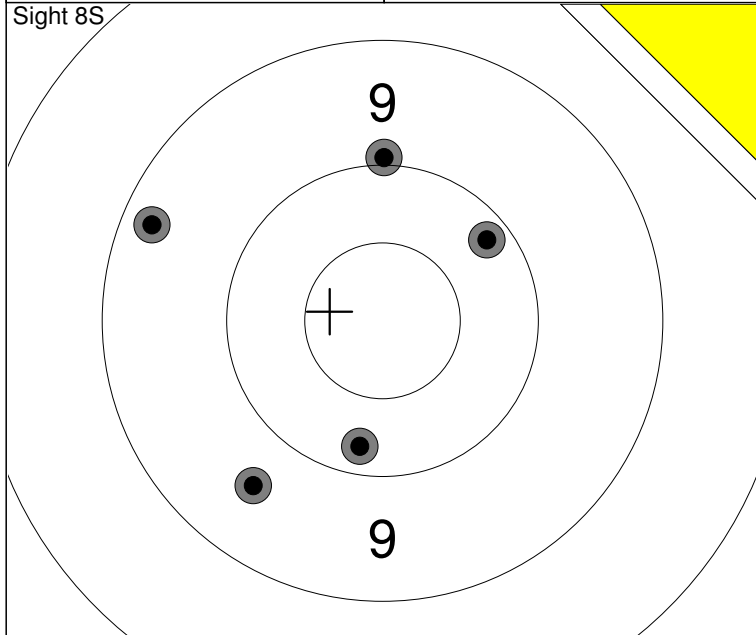

5: 0.02s 9.6 ↘
4: 3.67s 10.2 ↓
3: 5.10s 10.1 ↗
2: 6.23s 10.0 ↑
1: 7.62s 9.3 ↙

Series	48 (0x)
Series	0 (0x)

5: 2.49s 10.2 ↓
4: 3.68s 7.0 ↗
3: 4.69s 9.2 ↗
2: 5.63s 10.0 ↗
1: 6.71s 8.9 ↗

5: 3.18s 8.3 →
4: 4.25s 10.4 ↖
3: 5.35s 9.9 ↗
2: 6.30s 10.7x ↓
1: 7.42s 8.5 ↙

Series	89 (1x)
Series	89 (1x)

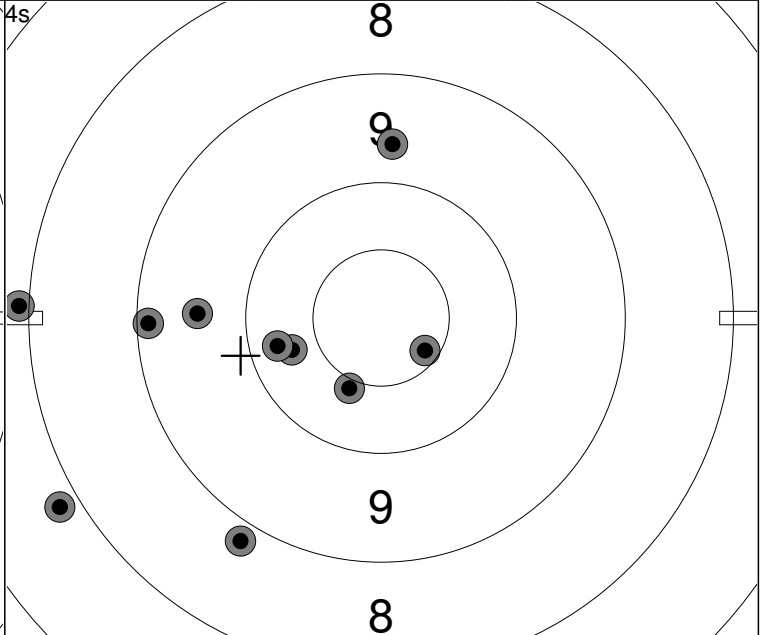
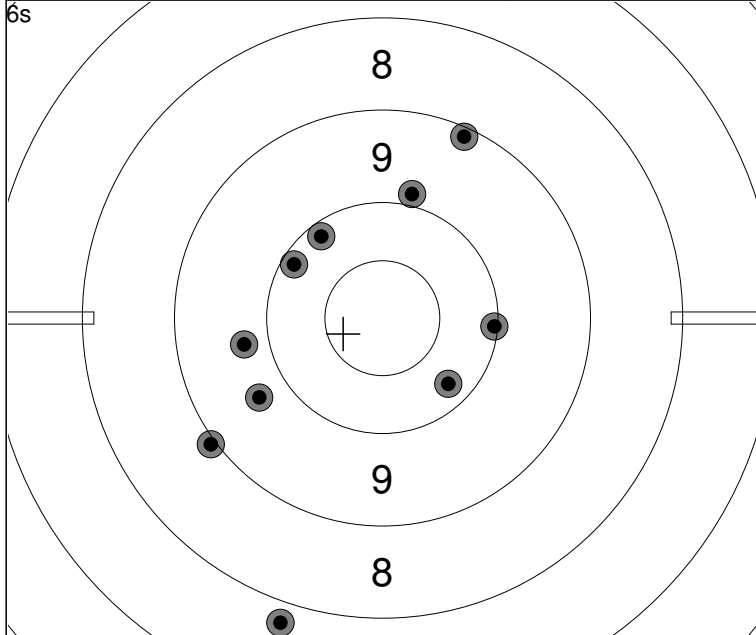

5: 2.42s 10.2 ↘
4: 3.25s 9.7 ↖
3: 4.12s 9.1 ↗
2: 4.84s 9.7 ↙
1: 5.73s 10.1 ↙

5: 2.31s 10.0 →
4: 3.06s 7.8 ↓
3: 3.98s 9.0 ↙
2: 4.82s 9.9 ↗
1: 5.69s 10.1 ↙

Series	92 (0x)
Series	181 (1x)

5: 0.06s 10.3 ↙
4: 2.18s 10.6x ↘
3: 2.78s 9.7 ↑
2: 3.35s 7.9 ↙
1: 3.93s 9.6 ↙

5: 1.77s 7.8 ↙
4: 2.28s 10.2 ↙
3: 2.79s 10.4 ↓
2: 3.39s 8.8 ↓
1: 3.96s 9.1 ↙

Series	89 (1x)
Series	270 (2x)

Relay 2	Lane 18	ZHANG Zhuang
-------------------	-------------------	---------------------

AHA Provincials	BC	SR	MP
-----------------	----	----	----

06.06.2026	2026 AB ISSF RF S1	Alberta Handgun Association
------------	--------------------	-----------------------------

Comment	Signature
---------	-----------

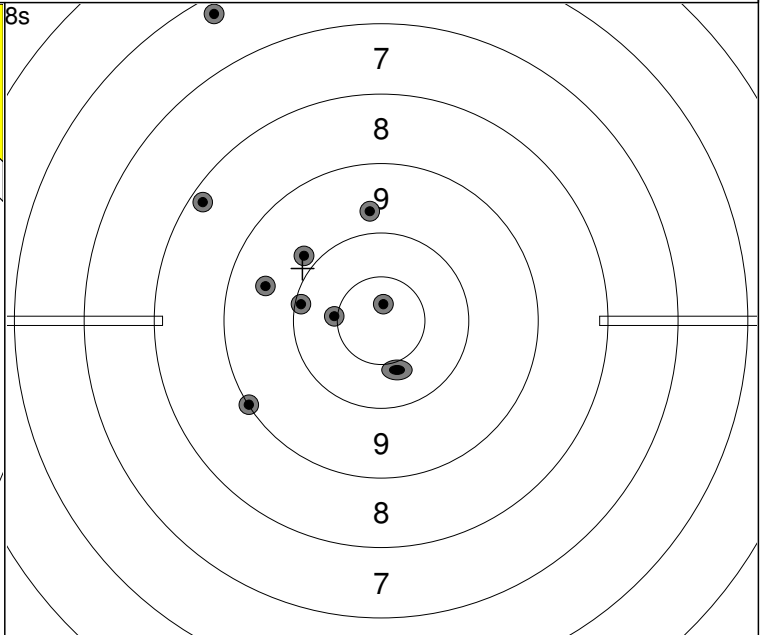
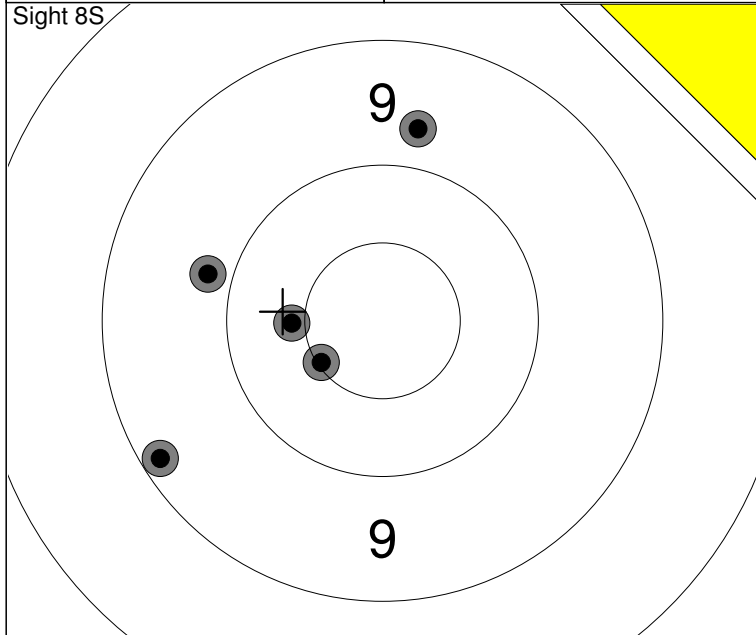

1: 2.36s 9.7 ↑
2: 3.56s 10.4 ←
3: 4.60s 10.5x ↙
4: 5.91s 9.2 ↙
5: 7.04s 9.8 ←

Series	47 (1x)
Series	0 (0x)

1: 1.98s 9.7 ↑
2: 3.04s 10.8x ↑
3: 4.22s 10.1 ←
4: 5.24s 9.8 ↗
5: 6.29s 6.3 ↗

1: 2.22s 9.5 ←
2: 3.85s 10.4x ←
3: 5.13s 9.0 ↙
4: 7.48s 8.2 ↙
5: 0.24s ↘

Series	80 (2x)
Series	80 (2x)

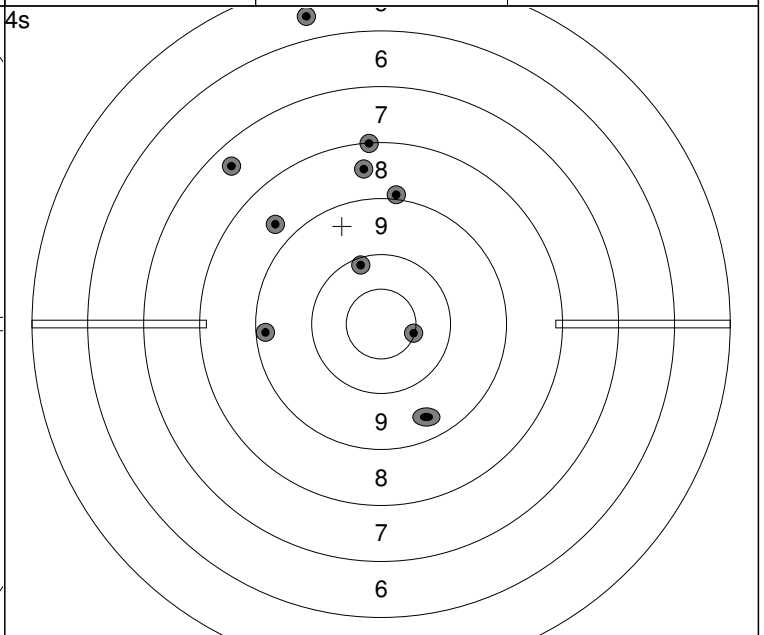
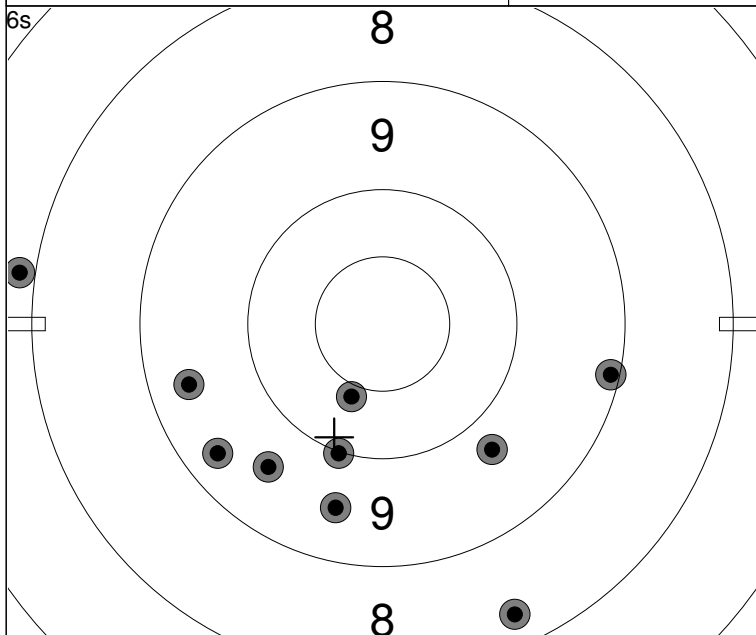

1: 2.08s 9.3 ↙
2: 2.97s 10.0 ↓
3: 3.84s 9.7 ↘
4: 4.69s 8.3 ↓
5: 5.59s 9.5 ↓

1: 1.78s 10.4 ↓
2: 2.59s 7.9 ←
3: 3.42s 9.4 ←
4: 4.30s 9.6 ↙
5: 5.17s 9.1 →

Series	89 (0x)
Series	169 (2x)

1: 1.89s 5.6 ↑
2: 2.55s 8.9 ↑
3: 3.31s 10.1 ↑
4: 3.83s 10.5x →
5: 0.02s ↘

1: 1.54s 9.2 ←
2: 2.24s 8.0 ↑
3: 2.86s 7.4 ↗
4: 3.40s 8.7 ↗
5: 3.95s 8.5 ↑

Series	73 (1x)
Series	242 (3x)

Relay 3	Lane 8	<h1>MALIK Anshul</h1>
-------------------	------------------	-----------------------

AHA Provincials	SK	SR	MP
-----------------	----	----	----

06.06.2026	2026 AB ISSF RF S1	Alberta Handgun Association
------------	--------------------	-----------------------------

Comment	Signature
---------	-----------

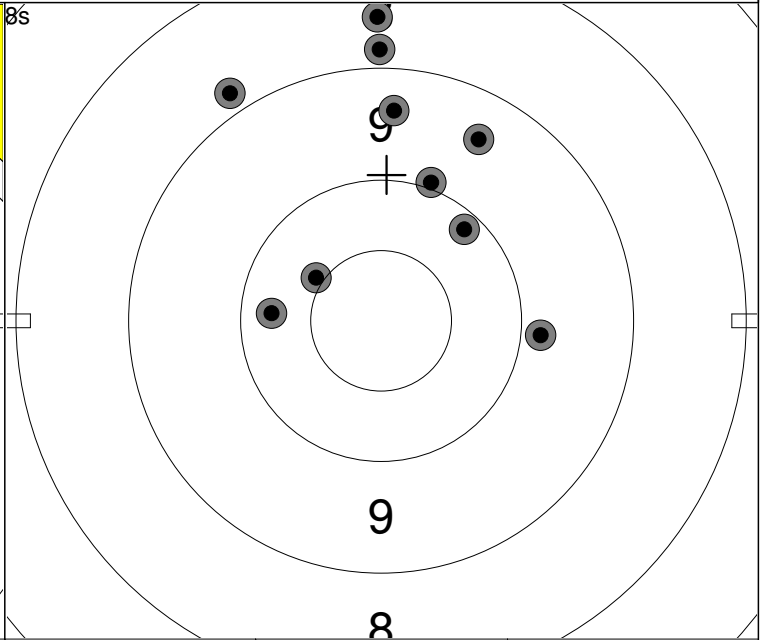
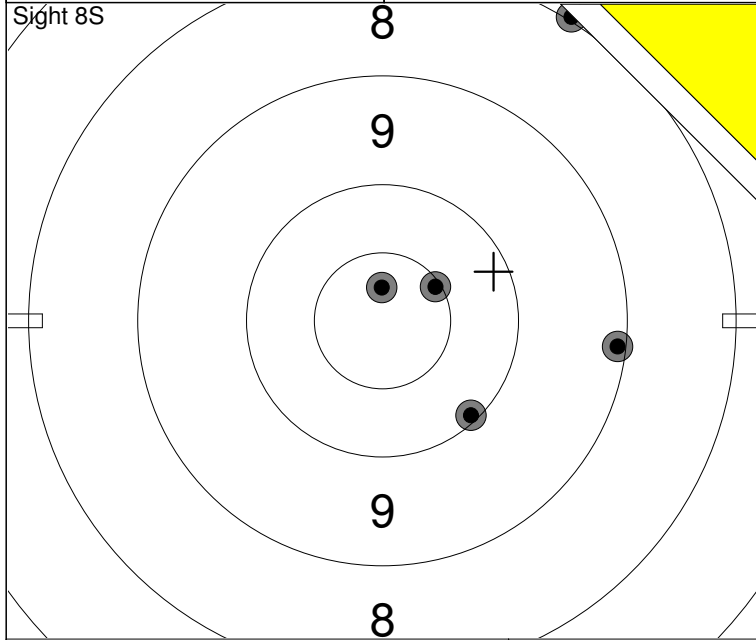

5: 3.19s 10.0 ↘
4: 4.60s 8.0 ↗
3: 5.89s 10.7x ↑
2: 6.97s 10.5x ↗
1: 8.24s 9.1 →

Series	47 (2x)
	0 (0x)

5: 3.14s 9.8 →
4: 4.43s 8.6 ↑
3: 5.49s 10.2 ←
2: 6.37s 10.4x ↖
1: 7.27s 10.0 ↑

5: 4.00s 10.1 ↗
4: 5.15s 8.9 ↑
3: 6.30s 9.4 ↑
2: 7.21s 9.4 ↗
1: 8.16s 8.8 ↖

Series	91 (1x)
	91 (1x)

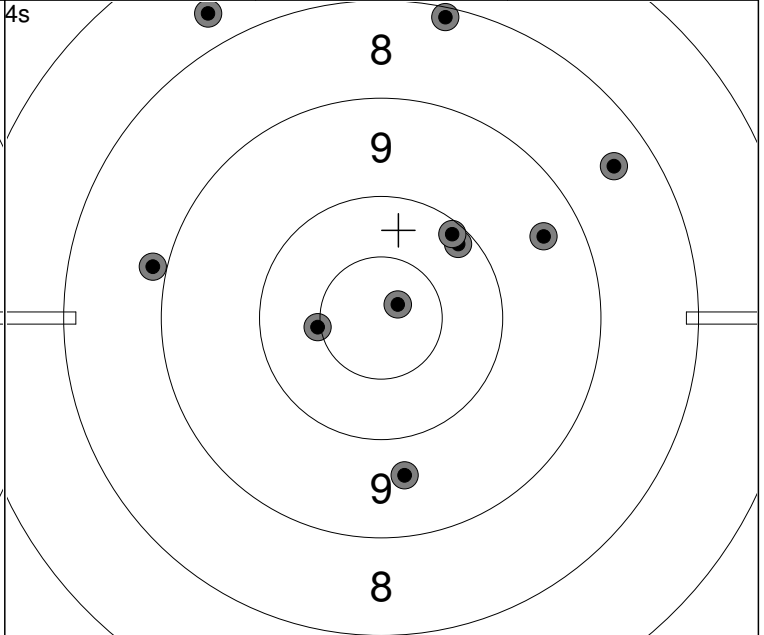
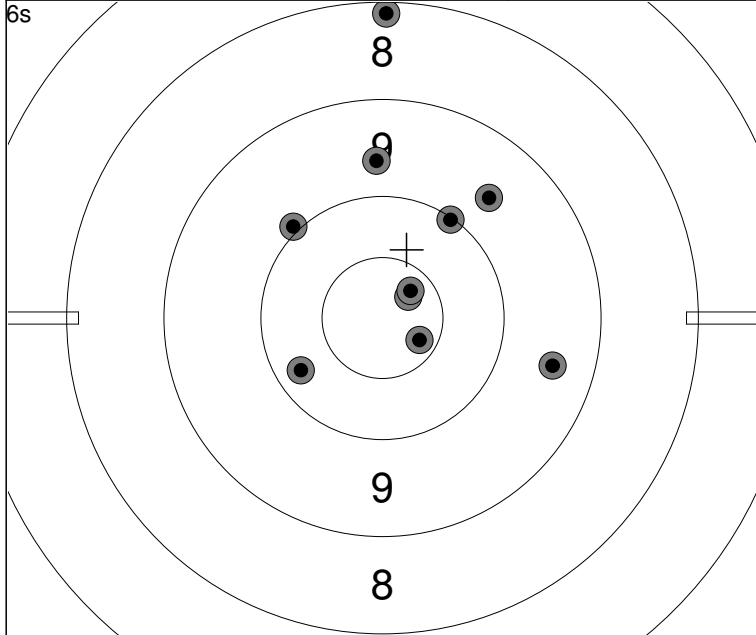

5: 2.35s 9.5 →
4: 3.31s 10.2 ↖
3: 4.19s 10.6x ↘
2: 4.91s 9.7 ↑
1: 5.59s 10.0 ↗

5: 2.54s 10.7x ↗
4: 3.46s 9.6 ↗
3: 4.36s 9.9 ↖
2: 5.04s 8.1 ↑
1: 5.72s 10.6x ↗

Series	94 (3x)
	185 (4x)

5: 1.75s 10.1 ↗
4: 2.34s 9.4 ↗
3: 2.91s 8.4 ↗
2: 3.43s 10.5x ←
1: 3.93s 10.8x ↗

5: 1.81s 9.6 ↓
4: 2.38s 8.1 ↑
3: 2.85s 8.9 ←
2: 3.32s 10.1 ↗
1: 3.79s 7.7 ↖

Series	89 (2x)
	274 (6x)

Relay 3	Lane 13	ZHANG Ruopeng
-------------------	-------------------	----------------------

AHA Provincials	BC	SR	MP
-----------------	----	----	----

06.06.2026	2026 AB ISSF RF S1	Alberta Handgun Association
------------	--------------------	-----------------------------

Comment	Signature
---------	-----------

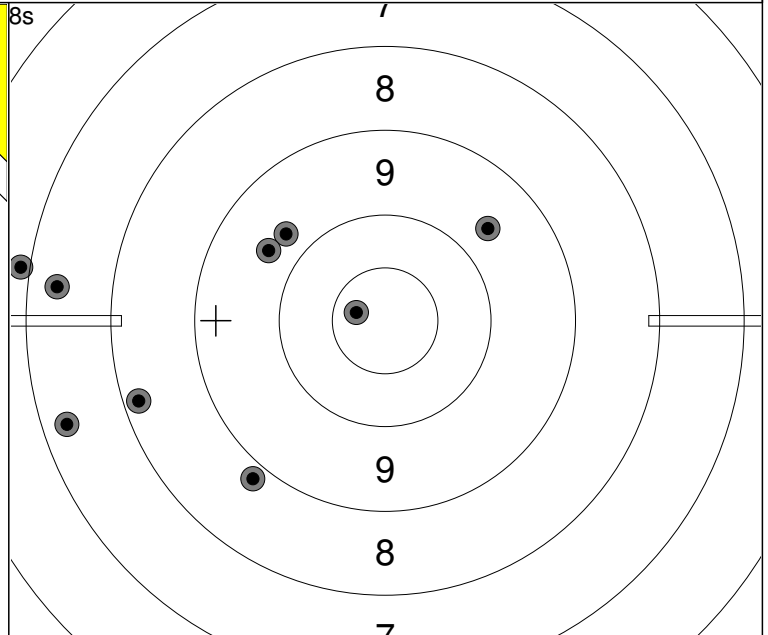
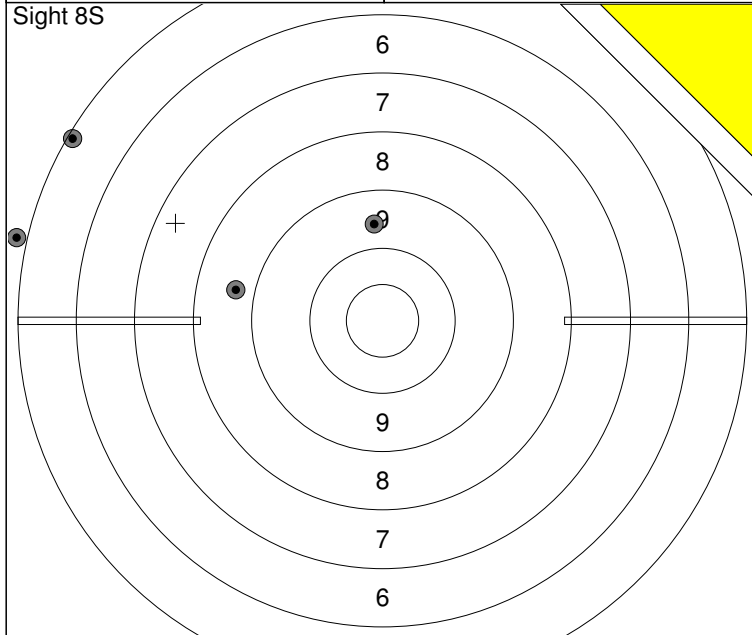

5: 0.04s <input checked="" type="checkbox"/>					
4: 3.18s 0.0 ←				Series	22 (0x)
3: 4.04s 9.6 ↑					
2: 4.88s 5.1 ↖					0 (0x)
1: 5.80s 8.7 ←					

5: 2.20s 10.7x ←	5: 0.53s 9.7 ↖				
4: 3.33s 8.8 ↘	4: 3.29s 7.4 ←			Series	73 (1x)
3: 4.46s 6.9 ←	3: 4.37s 8.2 ←				
2: 5.58s 9.7 ↖	2: 5.56s 9.6 ↗				73 (1x)
1: 6.60s 7.3 ←	1: 6.73s <input checked="" type="checkbox"/>				

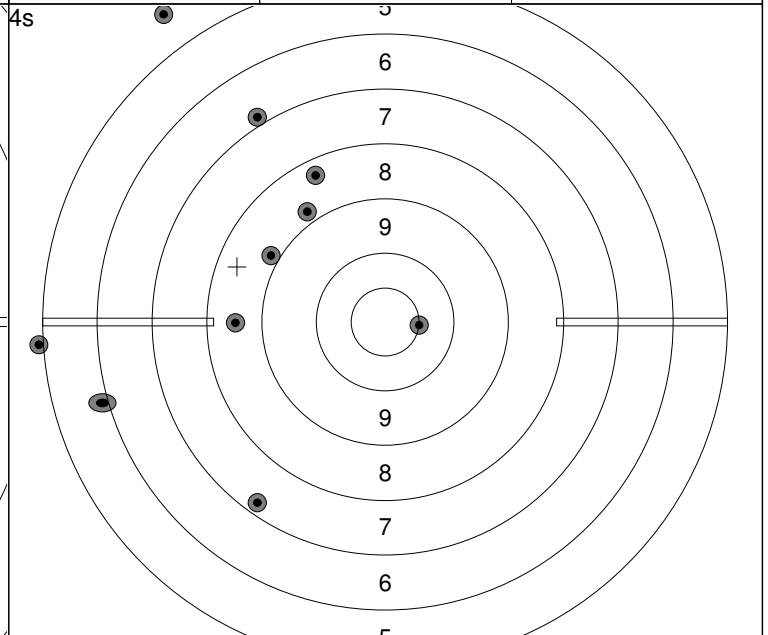
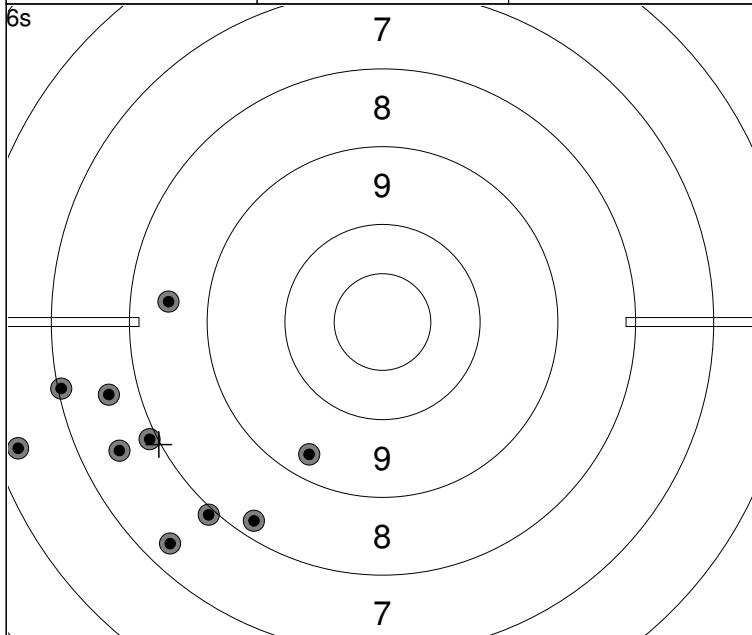

5: 0.52s 8.2 ↘	5: 0.46s 6.3 ←				
4: 2.88s 7.1 ←	4: 2.66s 8.5 ←			Series	73 (0x)
3: 3.88s 7.5 ←	3: 3.58s 7.9 ↘				
2: 4.81s 7.9 ←	2: 4.43s 7.6 ←				146 (1x)
1: 5.70s 9.3 ↘	1: 5.20s 7.3 ↘				

5: 0.32s 0.0 ↗	5: 1.53s 8.9 ↖				
4: 2.43s 8.5 ←	4: 2.22s 7.2 ↘			Series	55 (1x)
3: 3.11s 6.9 ↗	3: 2.88s 8.8 ↗				
2: 3.88s 10.5x →	2: 3.50s 0.0 ←				201 (2x)
1: 0.17s <input checked="" type="checkbox"/>	1: 4.06s 8.3 ↗				

Relay 3	Lane 18	ZHAO Yingli
-------------------	-------------------	--------------------

AHA Provincials	BC	SR	MP
-----------------	----	----	----

06.06.2026	2026 AB ISSF RF S1	Alberta Handgun Association
------------	--------------------	-----------------------------

Comment	Signature
---------	-----------

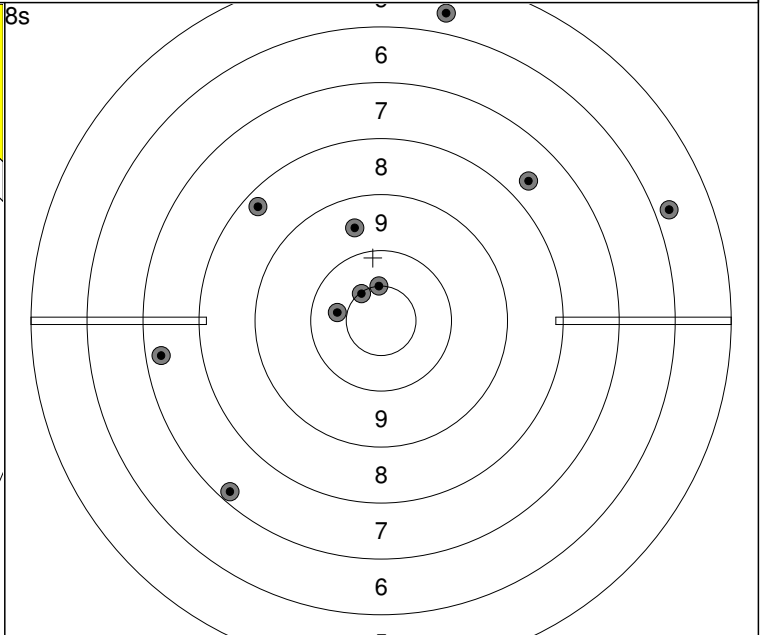
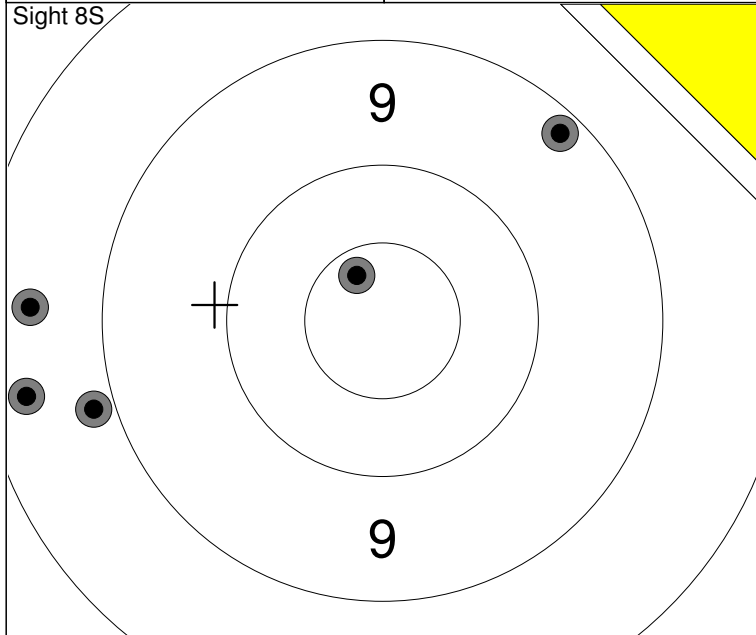

5: 2.12s	8.8	←
4: 2.93s	8.4	←
3: 3.89s	8.3	←
2: 4.91s	10.6x	↗
1: 5.81s	9.2	↗

Series	43 (1x)
Series	0 (0x)

5: 1.91s	10.3	←
4: 3.10s	9.5	↑
3: 4.30s	10.5x	↖
2: 5.32s	5.7	↑
1: 6.50s	10.5x	↑

5: 2.13s	5.8	↗
4: 3.04s	7.6	↗
3: 4.49s	7.2	↘
2: 5.61s	7.3	←
1: 6.62s	8.3	↖

Series	78 (2x)
Series	78 (2x)

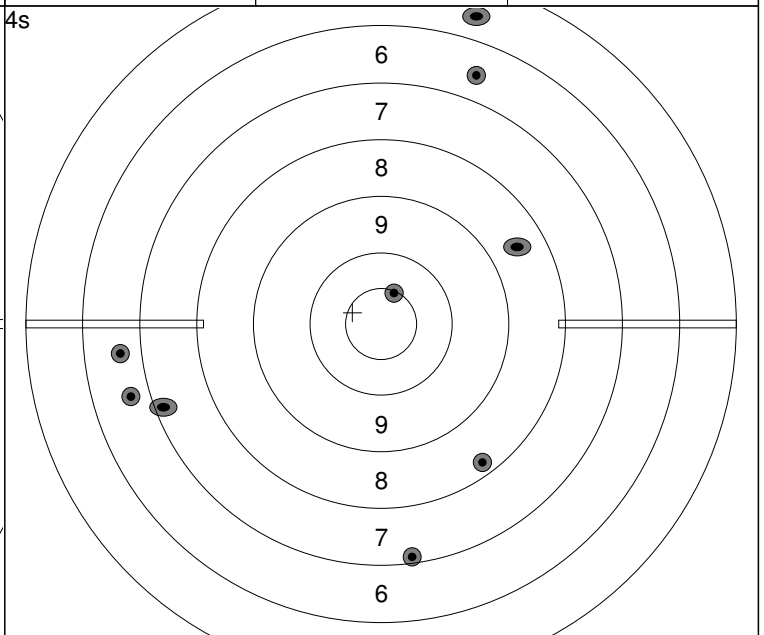
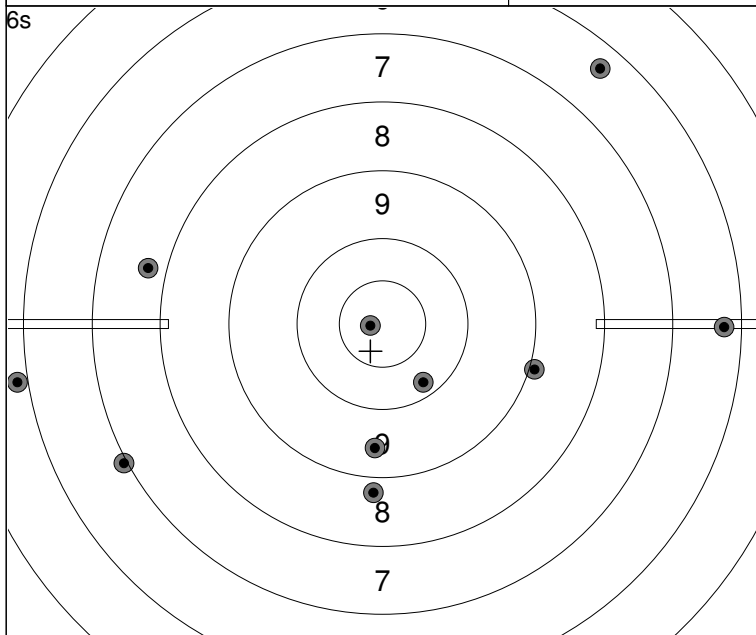

5: 1.84s	6.4	↗
4: 2.66s	10.2	↘
3: 3.69s	10.8x	←
2: 4.54s	6.3	→
1: 5.40s	7.0	←

5: 1.66s	8.9	→
4: 3.13s	8.8	↓
3: 3.96s	7.7	←
2: 4.77s	9.5	↓
1: 5.86s	5.9	←

Series	76 (1x)
Series	154 (3x)

5: 1.87s	8.3	↘
4: 2.87s	6.7	←
3: 3.70s	10.5x	↗
2: 0.01s	7.2	↖
1: 0.45s	7.2	↖

5: 1.64s	6.6	←
3: 2.98s	7.1	↓
2: 3.75s	6.6	↗
1: 0.01s	7.2	↖
4:	--	

Series	43 (1x)
Series	197 (4x)

Relay 1	Lane 8	<h1>MARKEWICZ Alan</h1>
-------------------	------------------	-------------------------

AHA Provincials	AB	SR	MP
-----------------	----	----	----

06.06.2026	2026 AB ISSF RF S2	Alberta Handgun Association
------------	--------------------	-----------------------------

Comment	Signature
---------	-----------

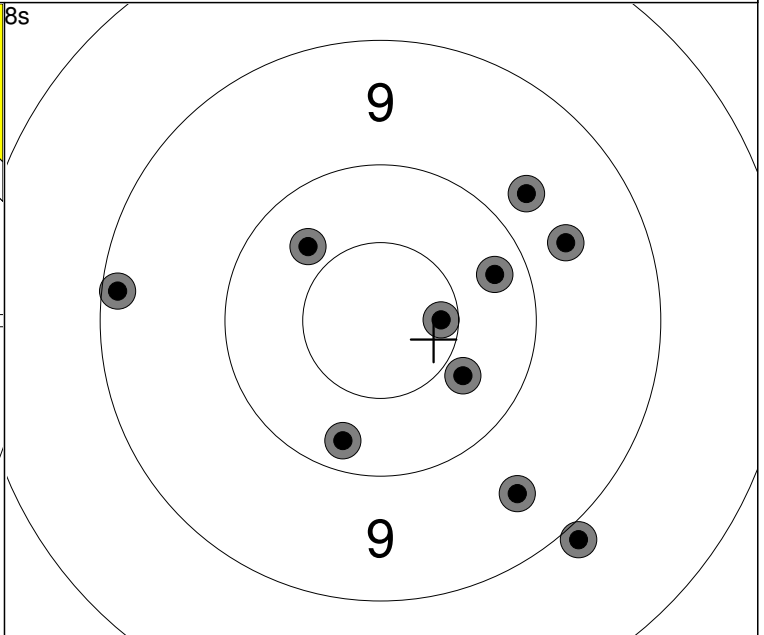
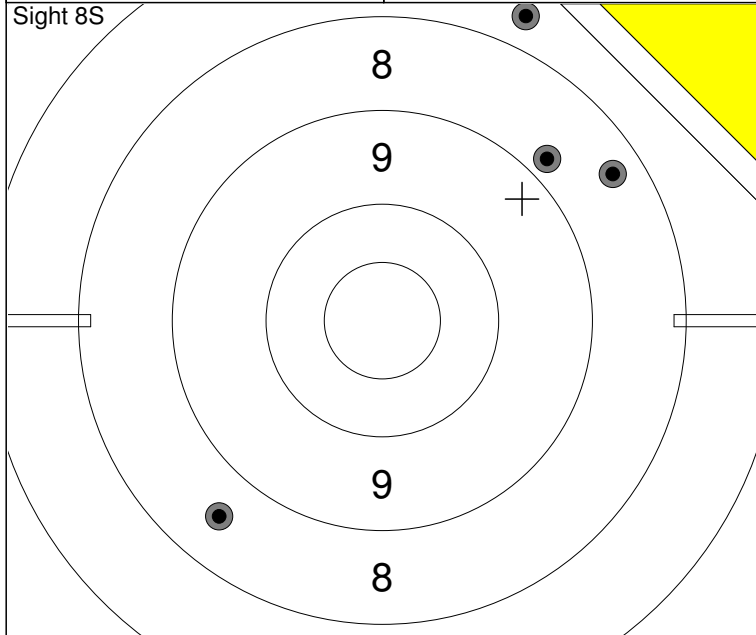

5: 2.39s 8.8 ↗
4: 3.29s 7.1 ↗
3: 4.19s 8.3 ↗
2: 5.21s 8.5 ↘
1: 6.95s 7.7 ↗

Series	38 (0x)
	0 (0x)

5: 2.15s 9.1 ←
4: 3.20s 10.2 →
3: 4.18s 10.6x →
2: 5.17s 10.3 ↘
1: 7.14s 9.5 ↘

5: 2.37s 9.7 ↗
4: 3.42s 10.2 ↘
3: 4.45s 8.9 ↘
2: 5.90s 10.3 ↗
1: 6.81s 9.7 →

Series	94 (1x)
	94 (1x)

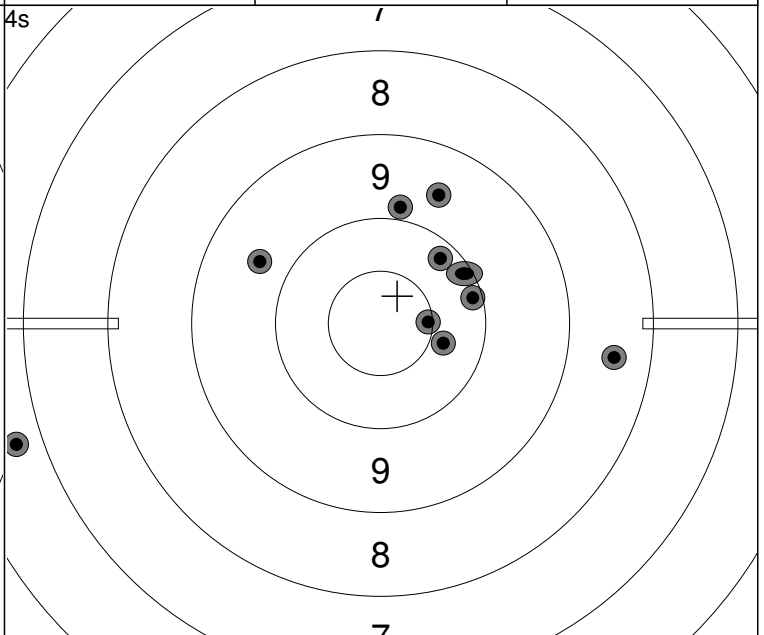
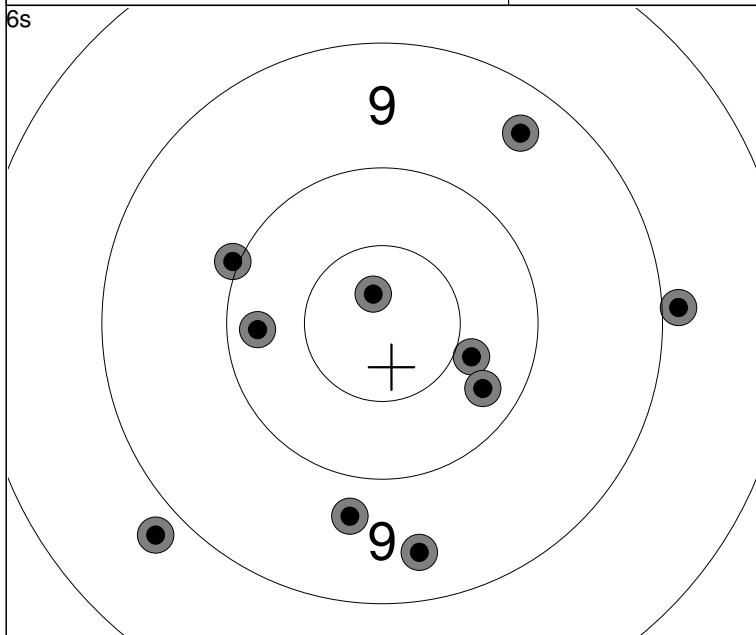

5: 2.11s 9.7 ↓
4: 2.89s 10.0 ↖
3: 3.72s 10.4 →
2: 4.67s 9.4 ↓
1: 5.62s 8.9 →

5: 1.98s 10.2 →
4: 2.75s 8.8 ↘
3: 3.51s 10.2 ←
2: 4.38s 9.4 ↗
1: 5.53s 10.8x ↗

Series	93 (1x)
	187 (2x)

5: 1.83s 9.9 ↑
4: 2.41s 9.7 ↖
3: 3.01s 10.2 ↗
2: 3.52s 10.5x →
1: 4.03s 10.1 →

5: 1.78s 9.6 ↗
4: 2.40s 8.5 →
3: 3.02s 6.7 ←
2: 3.69s 10.4 →
1: 0.01s ↘

Series	81 (1x)
	268 (3x)

Relay 1	Lane 13	KNAUS Gordon
-------------------	-------------------	---------------------

AHA Provincials	AB	SR	MP
-----------------	----	----	----

06.06.2026	2026 AB ISSF RF S2	Alberta Handgun Association
------------	--------------------	-----------------------------

Comment	Signature
---------	-----------

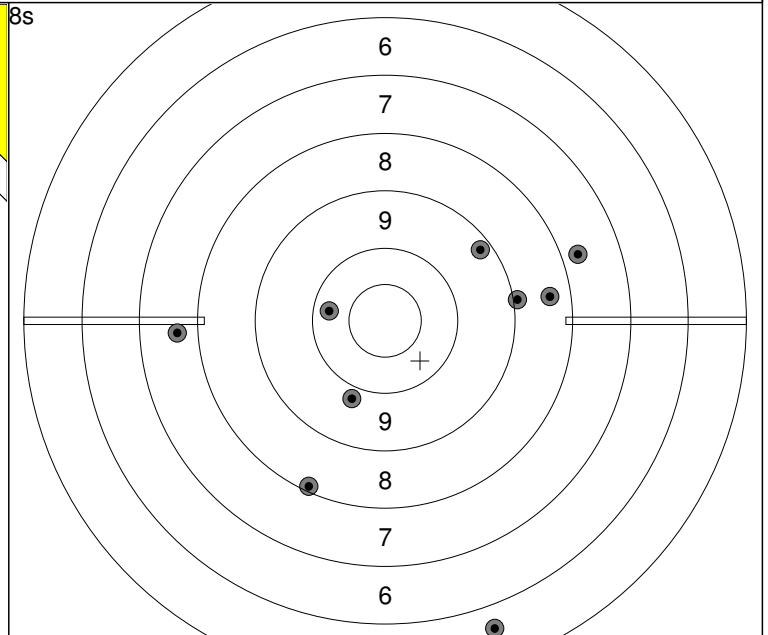
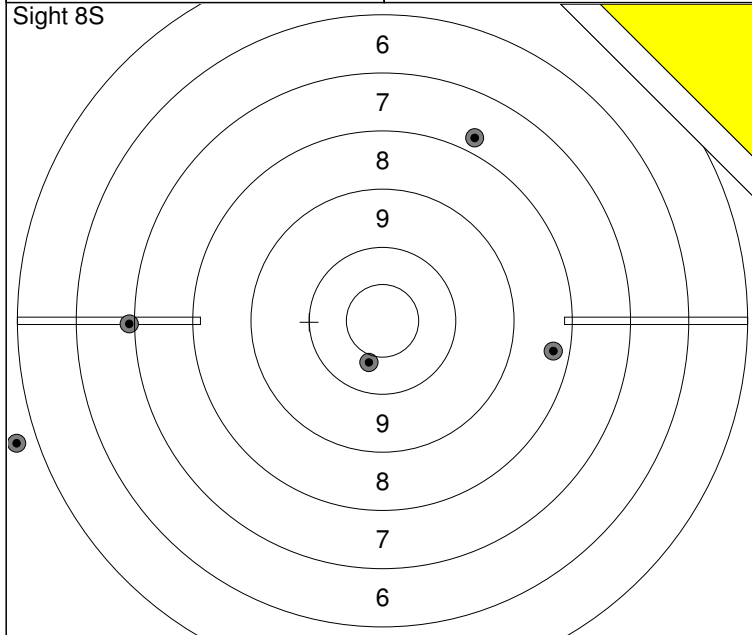

5: 2.28s 6.9 ←
4: 3.19s 0.0 ←
3: 4.37s 8.3 →
2: 5.47s 10.4 ↓
1: 6.34s 7.8 ↗

Series	31 (0x)
	0 (0x)

5: 1.87s ☒
4: 2.89s 7.7 ←
3: 4.10s 9.8 ↓
2: 5.07s 7.7 →
1: 6.55s 8.1 ↓

5: 2.04s 10.2 ←
4: 3.21s 5.6 ↓
3: 4.12s 8.4 →
2: 5.11s 8.9 →
1: 6.03s 9.2 ↗

Series	71 (0x)
	71 (0x)

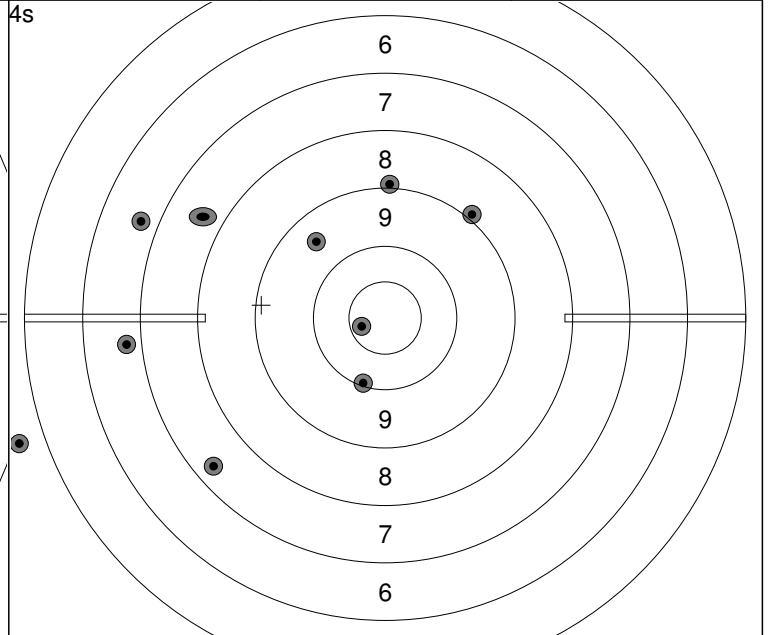
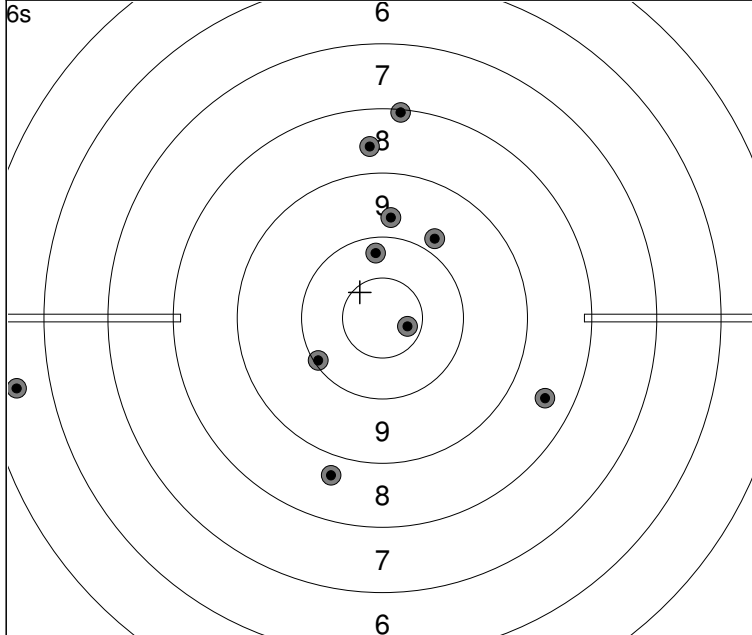

5: 2.00s 9.7 ↑
4: 2.75s 5.5 ←
3: 3.53s 10.2 ↑
2: 4.24s 8.5 ↘
1: 5.07s 9.8 ↗

5: 1.93s 8.1 ↑
4: 2.92s 8.7 ↓
3: 4.31s 10.6x →
2: 4.98s 8.6 ↑
1: 5.77s 10.1 ←

Series	85 (1x)
	156 (1x)

5: 1.86s 9.0 ↑
4: 2.35s 6.7 ←
3: 2.83s 6.8 ←
2: 3.40s 0.0 ←
1: 3.98s 10.1 ↓

5: 1.71s 7.3 ↘
4: 2.55s 8.9 ↗
3: 3.40s 10.6x ←
2: 4.04s 9.5 ↗
1: 0.29s ↘

Series	65 (1x)
	221 (2x)

Relay 1	Lane 18	DJAJA Yeremia
-------------------	-------------------	----------------------

AHA Provincials	AB	SR	MP
-----------------	----	----	----

06.06.2026	2026 AB ISSF RF S2	Alberta Handgun Association
------------	--------------------	-----------------------------

Comment	Signature
---------	-----------

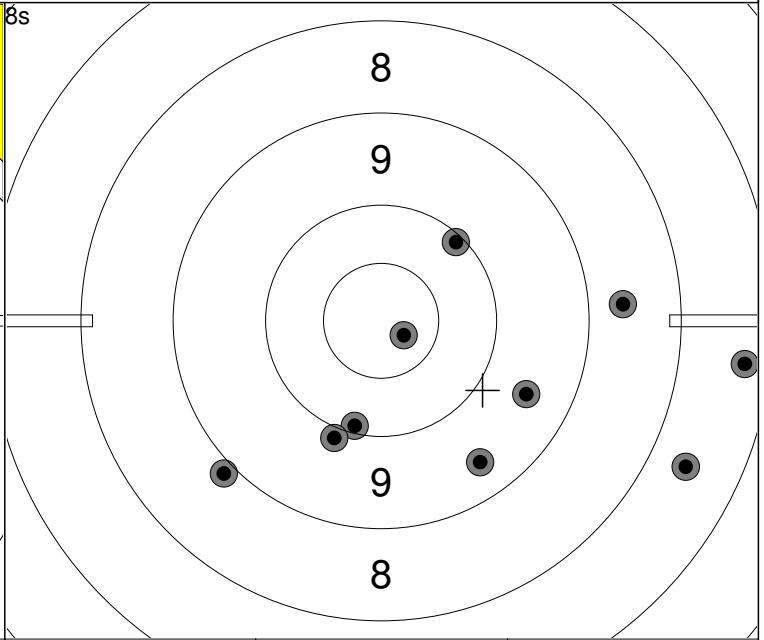
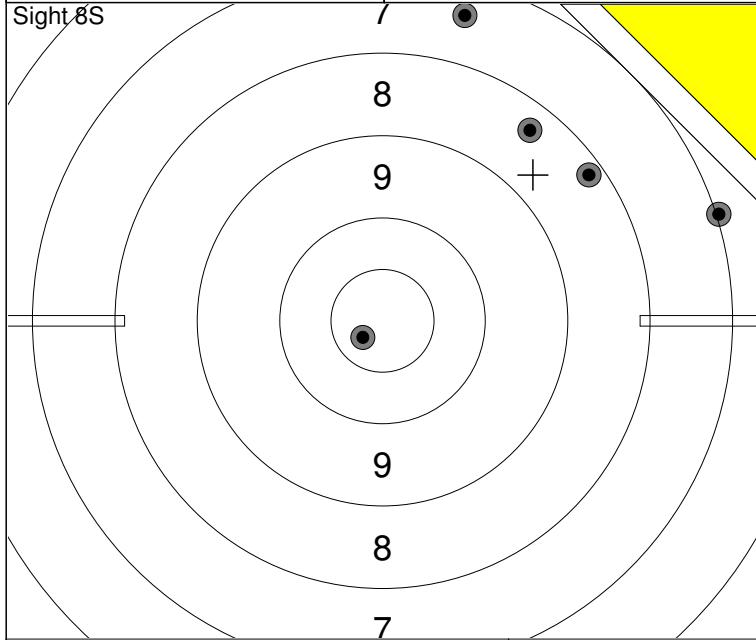

5: 3.48s 8.2 ↗
4: 4.40s 7.4 ↑
3: 5.31s 10.7x ↙
2: 6.34s 8.3 ↗
1: 7.11s 7.0 →

Series	40 (1x)
	0 (0x)

5: 2.12s 10.7x ↘
4: 3.29s 9.4 ↘
3: 4.30s 9.5 ↘
2: 5.36s 7.3 →
1: 6.29s 7.6 ↘

5: 2.19s 10.1 ↓
4: 3.20s 10.1 ↗
3: 4.15s 8.6 →
2: 5.27s 9.9 ↓
1: 6.29s 8.9 ↙

Series	87 (1x)
	87 (1x)

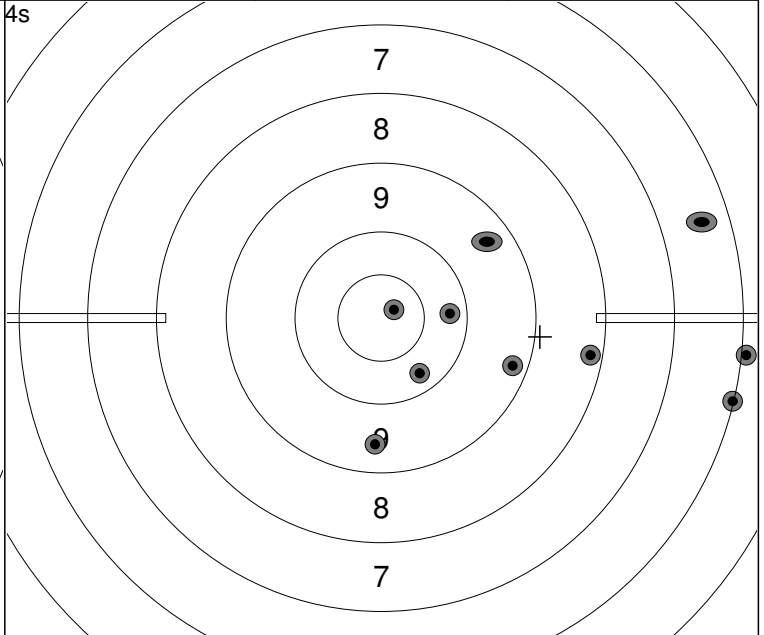
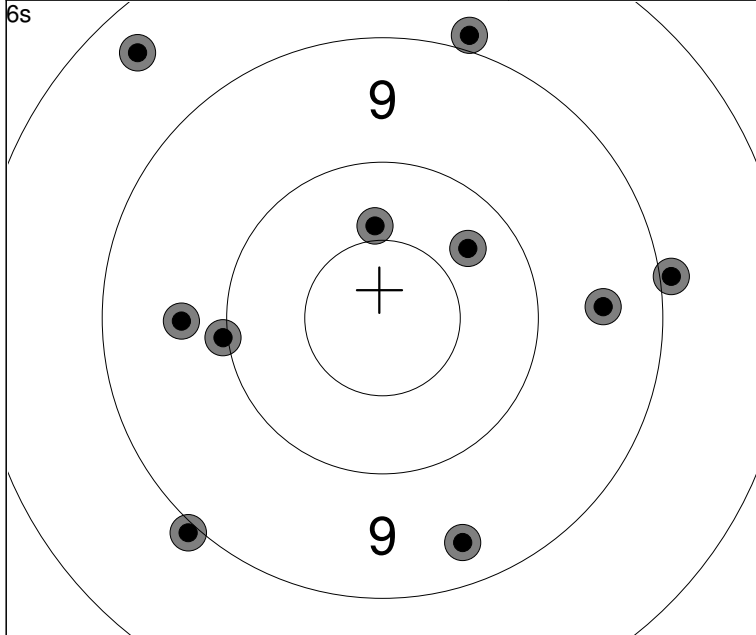

5: 1.87s 8.9 ↙
4: 2.77s 10.4 ↑
3: 3.68s 8.9 →
2: 4.65s 8.4 ↗
1: 5.49s 9.7 ←

5: 2.14s 10.3 ↗
4: 3.20s 9.4 ↓
3: 4.02s 8.9 ↑
2: 4.86s 9.5 →
1: 5.82s 10.0 ←

Series	89 (0x)
	176 (1x)

5: 1.58s 10.8x ↗
4: 2.55s 8.2 →
3: 3.29s 10.2 →
2: 4.05s 9.4 ↓
1: 0.55s ↘

5: 1.88s 6.0 →
4: 2.59s 6.0 →
3: 3.38s 10.2 ↘
2: 4.10s 9.2 ↘
1: 0.39s ↘

Series	68 (1x)
	244 (2x)

Relay 2	Lane 8	ZHANG Zhuang
-------------------	------------------	---------------------

AHA Provincials	BC	SR	MP
-----------------	----	----	----

06.06.2026	2026 AB ISSF RF S2	Alberta Handgun Association
------------	--------------------	-----------------------------

Comment	Signature
---------	-----------

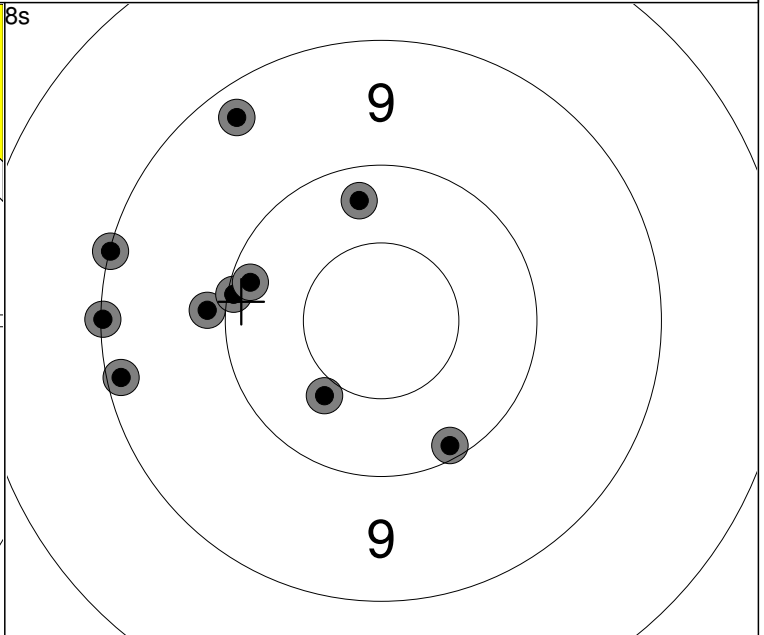
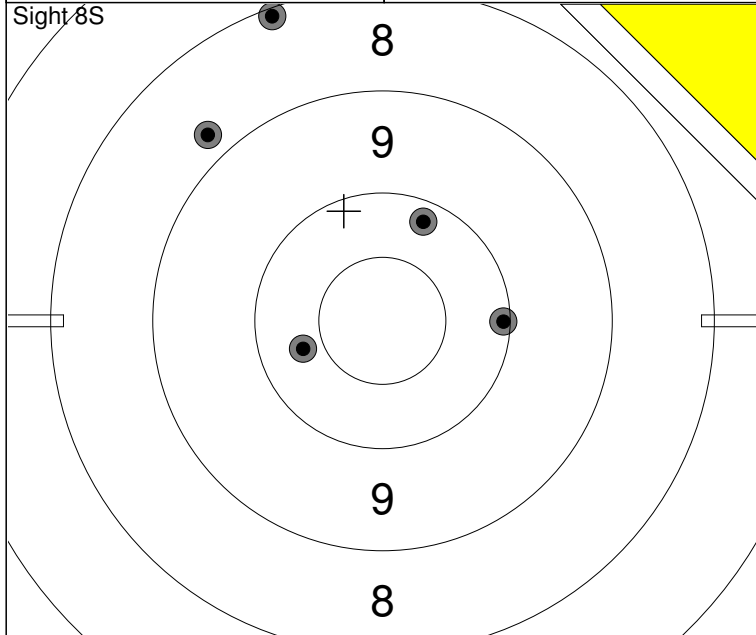

1: 2.34s	8.8	↖
2: 3.44s	10.2	↗
3: 4.52s	8.1	↗
4: 5.56s	10.1	→
5: 6.65s	10.3	←

Series	46 (0x)
	0 (0x)

1: 2.25s	9.0	←
2: 3.65s	9.0	←
3: 4.82s	9.9	←
4: 5.82s	9.1	←
5: 6.89s	10.0	←

1: 2.23s	9.3	↗
2: 3.59s	10.4	↘
3: 4.73s	10.2	↗
4: 5.83s	10.1	↘
5: 7.46s	10.1	←

Series	95 (0x)
	95 (0x)

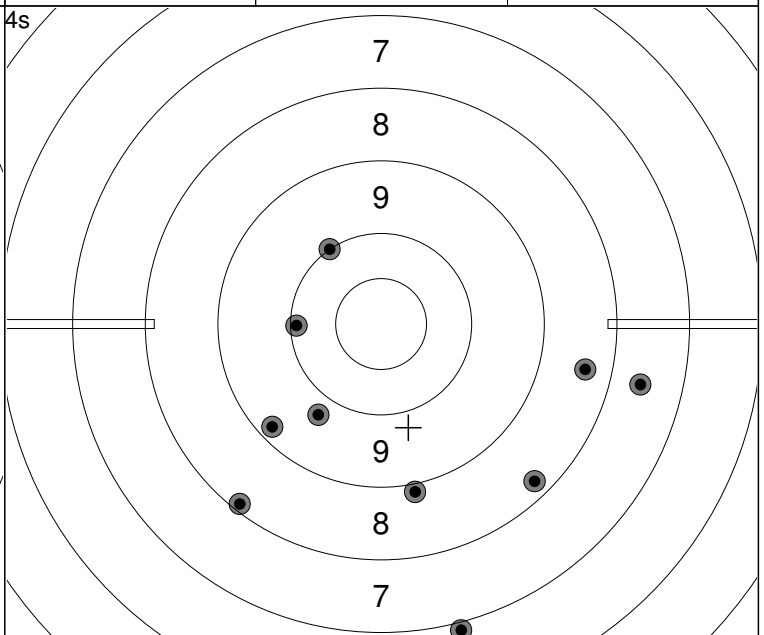
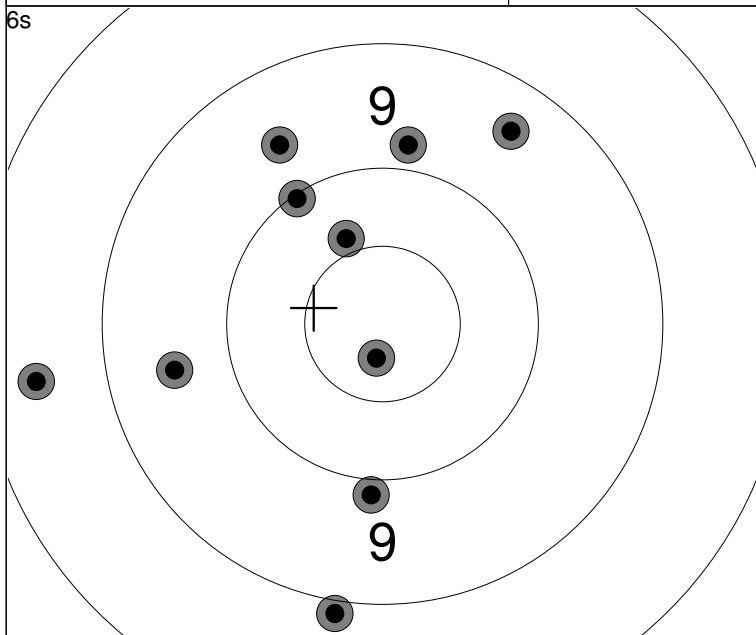

1: 1.78s	10.0	↗
2: 2.74s	10.4	↗
3: 3.58s	9.4	↗
4: 4.48s	10.7x	↘
5: 5.34s	9.6	←

1: 1.93s	9.9	↓
2: 2.83s	8.5	←
3: 3.73s	8.9	↓
4: 4.49s	9.8	↗
5: 5.44s	9.6	↗

Series	91 (1x)
	186 (1x)

1: 1.53s	7.6	→
2: 2.17s	9.7	↘
3: 2.78s	10.0	↗
4: 3.39s	8.9	↘
5: 3.92s	10.1	←

1: 1.56s	8.2	↘
2: 2.34s	8.4	→
3: 2.91s	9.2	↘
4: 3.43s	8.1	↘
5: 3.95s	6.9	↓

Series	83 (0x)
	269 (1x)

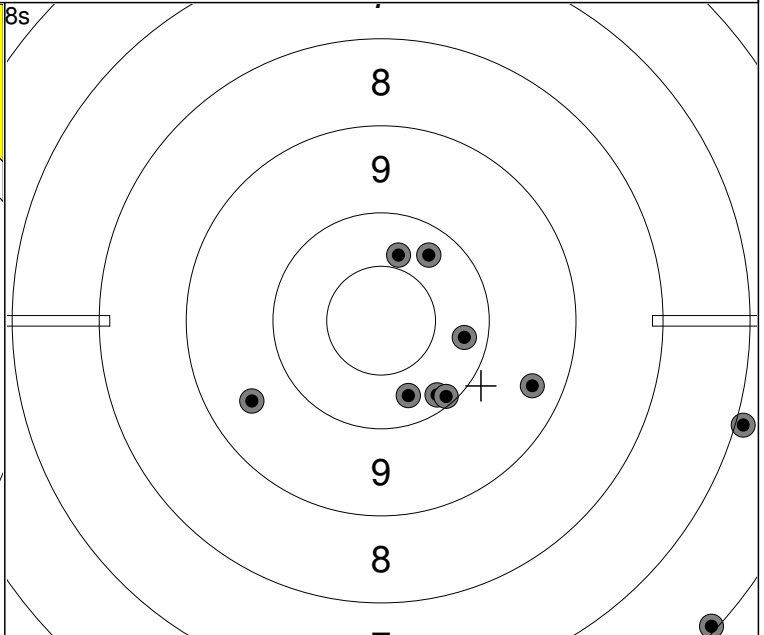
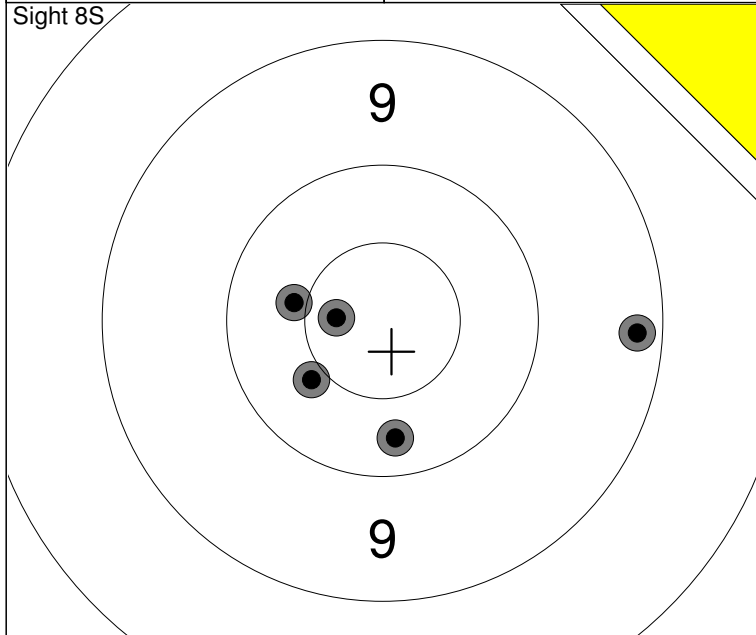

5: 2.42s 10.4 ←
4: 3.53s 10.7x ←
3: 4.58s 10.2 ↓
2: 5.68s 10.4 ↙
1: 6.73s 9.2 →

Series	49 (1x)
Series	0 (0x)

5: 2.39s 10.2 ↗
4: 3.62s 10.2 →
3: 4.71s 6.1 ↘
2: 5.99s 10.1 ↘
1: 7.28s 10.4 ↗

5: 2.25s 10.1 ↘
4: 3.27s 9.5 ↙
3: 4.37s 6.9 →
2: 5.70s 10.3 ↘
1: 6.66s 9.4 ↘

Series	90 (0x)
Series	90 (0x)

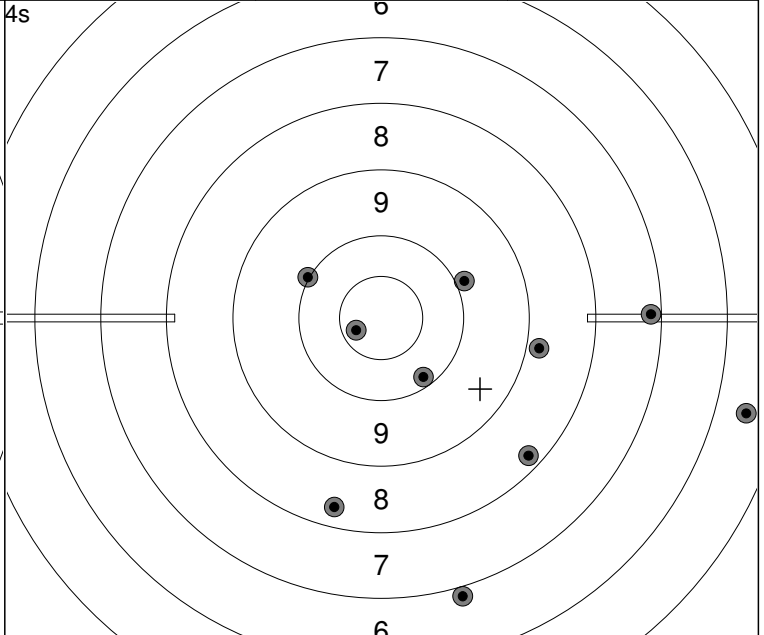
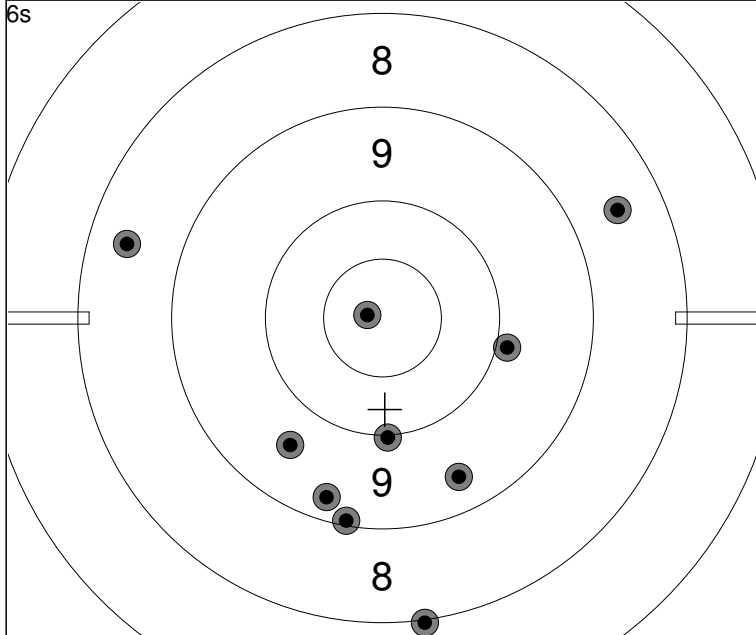

5: 2.08s 8.5 ↗
4: 2.90s 9.3 ↓
3: 3.65s 10.0 ↓
2: 4.35s 9.9 →
1: 5.10s 8.0 ↓

5: 2.03s 9.6 ↘
4: 2.90s 9.4 ↘
3: 3.81s 8.4 ←
2: 4.57s 10.8x ←
1: 5.32s 9.1 ↓

Series	89 (1x)
Series	179 (1x)

5: 1.84s 8.3 ↓
4: 2.37s 8.8 →
3: 2.91s 7.2 →
2: 3.32s 5.5 →
1: 3.87s 10.0 ↗

5: 1.76s 10.6x ←
4: 2.25s 6.9 ↓
3: 2.75s 9.9 →
2: 3.24s 10.1 ↘
1: 3.74s 8.2 ↓

Series	81 (1x)
Series	260 (2x)

Relay 2	Lane 18	OLSEN Jesse
-------------------	-------------------	--------------------

AHA Provincials	SK	SR	MP
-----------------	----	----	----

06.06.2026	2026 AB ISSF RF S2	Alberta Handgun Association
------------	--------------------	-----------------------------

Comment	Signature
---------	-----------

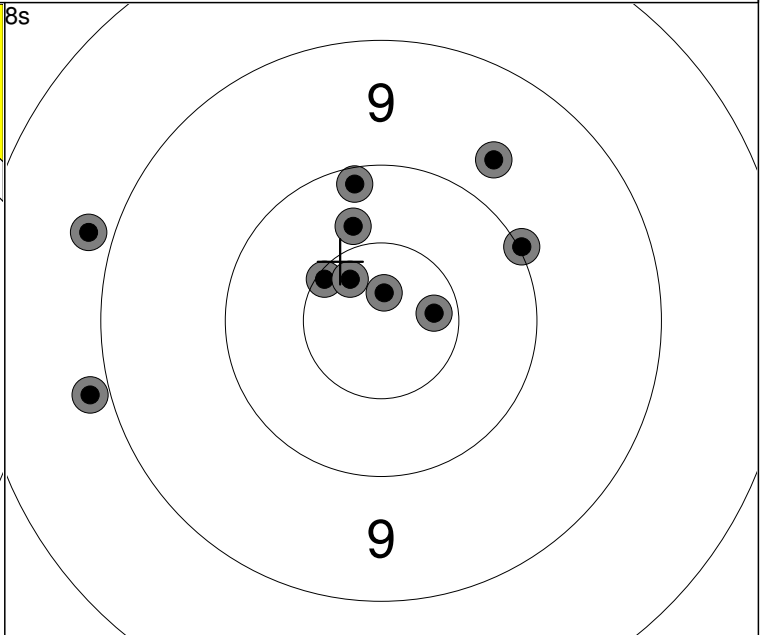
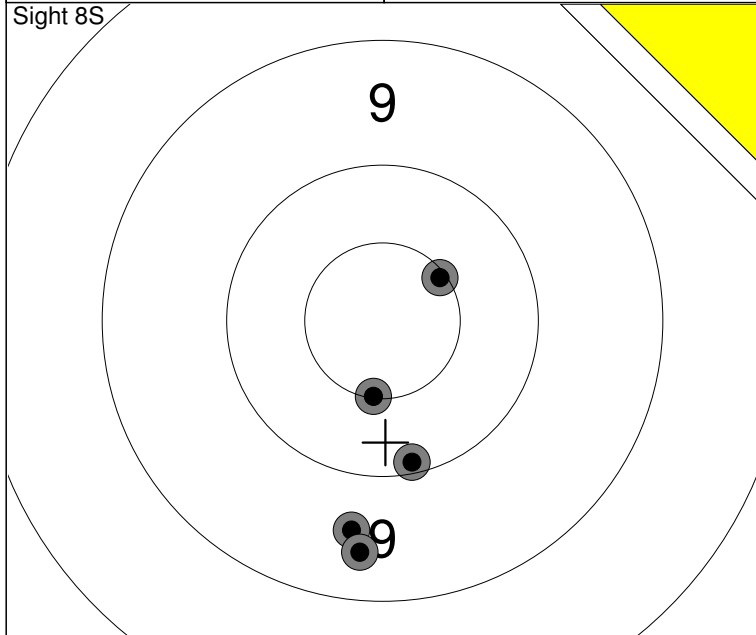

5: 2.43s 9.6 ↓
4: 3.71s 9.4 ↓
3: 4.76s 10.5x ↗
2: 5.79s 10.1 ↓
1: 6.80s 10.5x ↓

Series	48 (2x)
	0 (0x)

5: 2.37s 10.8x ↑
4: 3.47s 8.9 ←
3: 4.81s 10.3 ↑
2: 6.00s 8.8 ←
1: 7.31s 10.1 ↑

5: 2.24s 10.5x ↖
4: 3.48s 10.0 →
3: 4.56s 9.7 ↗
2: 5.58s 10.6x ↗
1: 7.02s 10.6x →

Series	95 (4x)
	95 (4x)

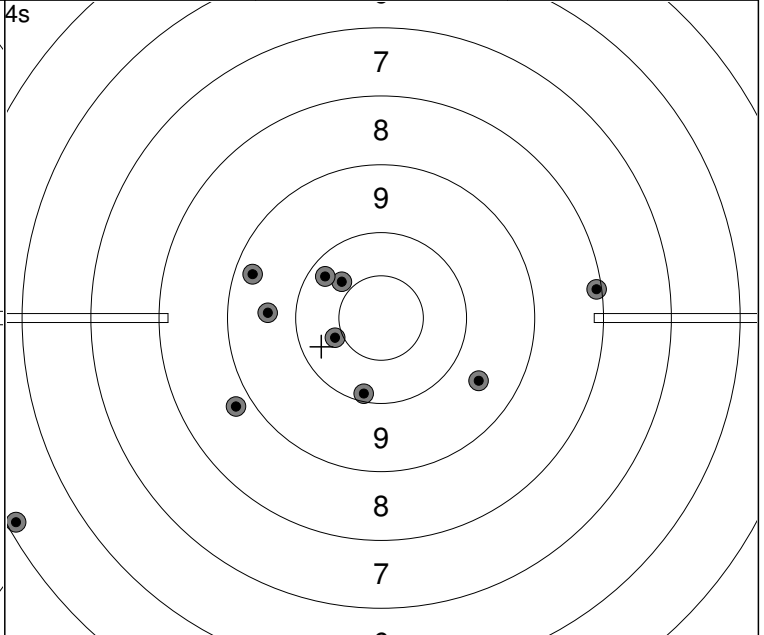
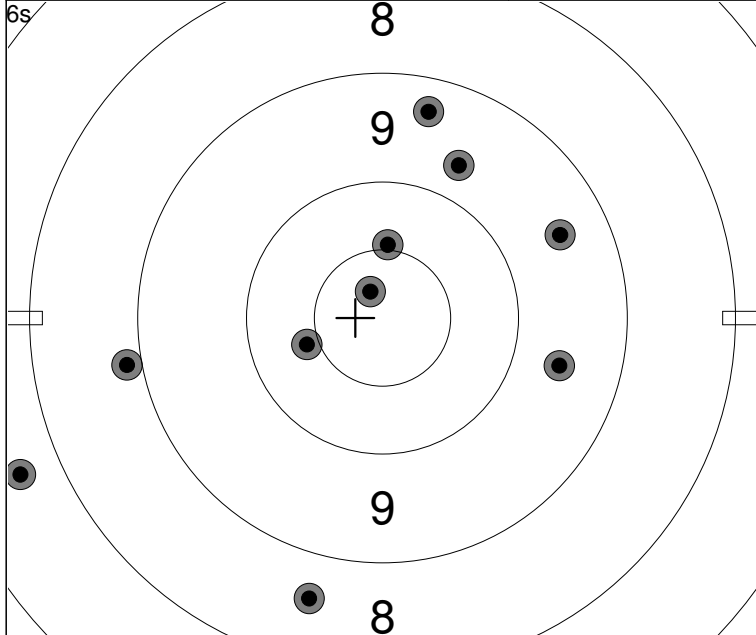

5: 1.90s 10.4 ←
4: 2.68s 7.6 ←
3: 3.52s 10.4x ↑
2: 4.32s 9.7 ↗
1: 5.14s 9.3 ↑

5: 2.27s 9.5 →
4: 3.03s 8.6 ↓
3: 3.80s 9.6 →
2: 4.66s 10.7x ↗
1: 5.50s 8.9 ←

Series	89 (2x)
	184 (6x)

5: 1.59s 10.4 ↖
4: 2.14s 8.8 ←
3: 2.69s 9.6 ←
2: 3.31s 10.2 ↖
1: 3.93s 10.4 ←

5: 1.69s 9.3 ←
4: 2.24s 9.6 ↘
3: 2.77s 8.1 →
2: 3.38s 5.1 ←
1: 3.95s 10.1 ↓

Series	88 (0x)
	272 (6x)

Relay 3	Lane 8	ZHAO Yingli
-------------------	------------------	--------------------

AHA Provincials	BC	SR	MP
-----------------	----	----	----

06.06.2026	2026 AB ISSF RF S2	Alberta Handgun Association
------------	--------------------	-----------------------------

Comment	Signature
---------	-----------

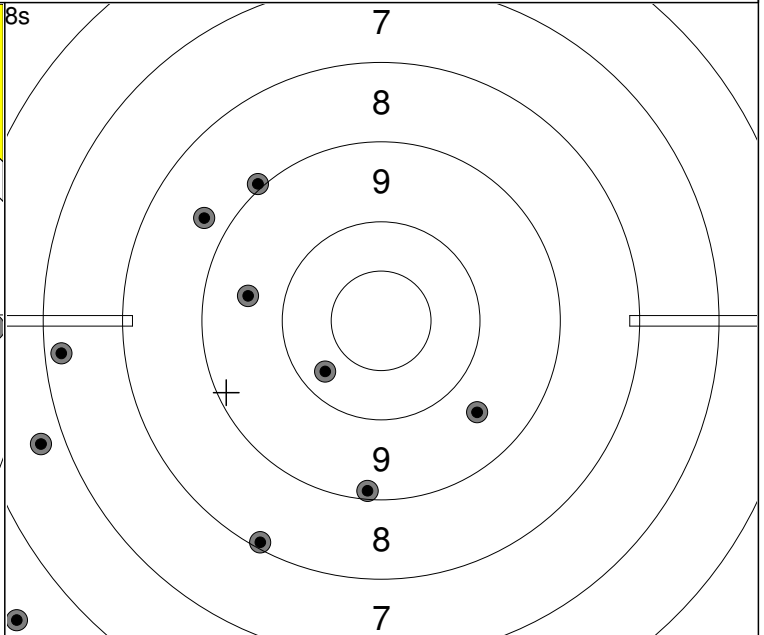
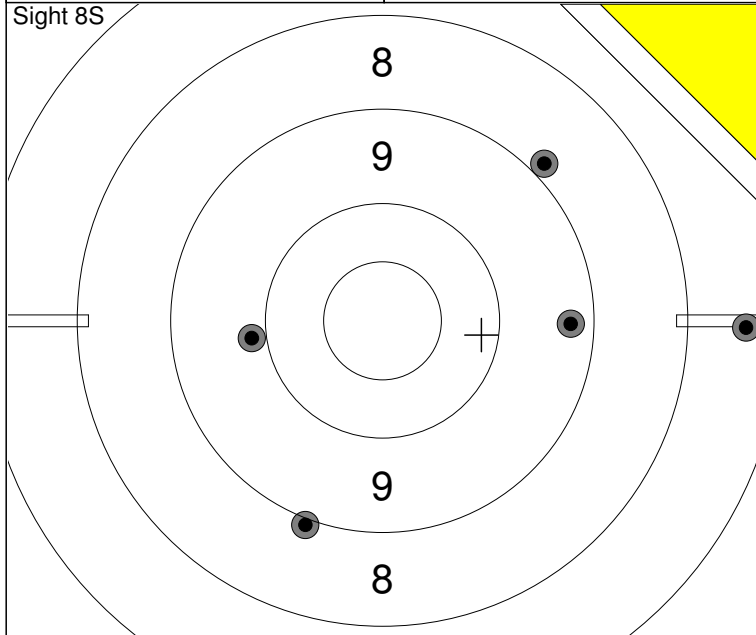

5: 2.32s 7.4 →
4: 3.64s 9.9 ←
3: 4.67s 8.9 ↓
2: 5.94s 9.3 →
1: 7.11s 8.9 ↗

Series	41 (0x)
	0 (0x)

5: 2.49s 9.6 ↘
4: 3.59s 9.0 ↗
3: 4.93s 5.3 ↙
2: 6.13s 6.7 ←
1: 7.78s 8.7 ↖

5: 2.36s 8.1 ↘
4: 3.47s 7.2 ←
3: 4.45s 10.2 ↙
2: 5.48s 9.1 ↓
1: 6.57s 9.6 ←

Series	80 (0x)
	80 (0x)

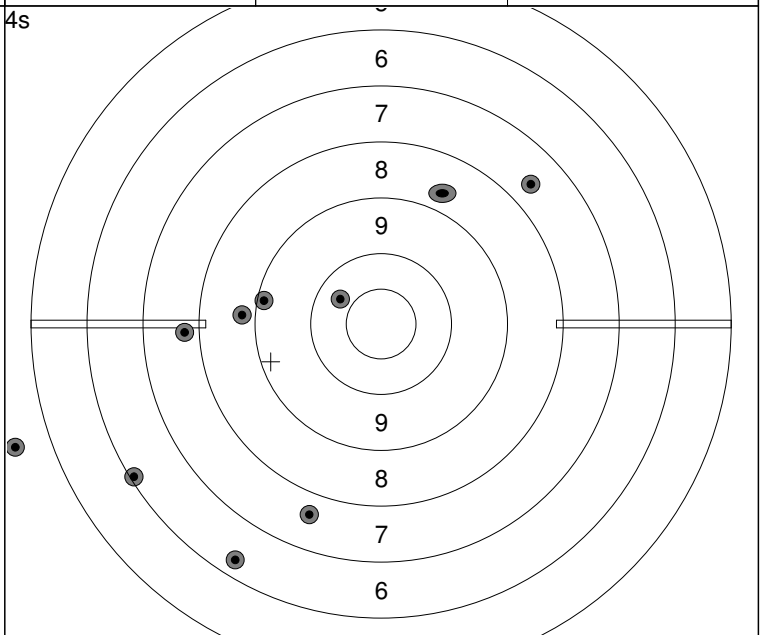
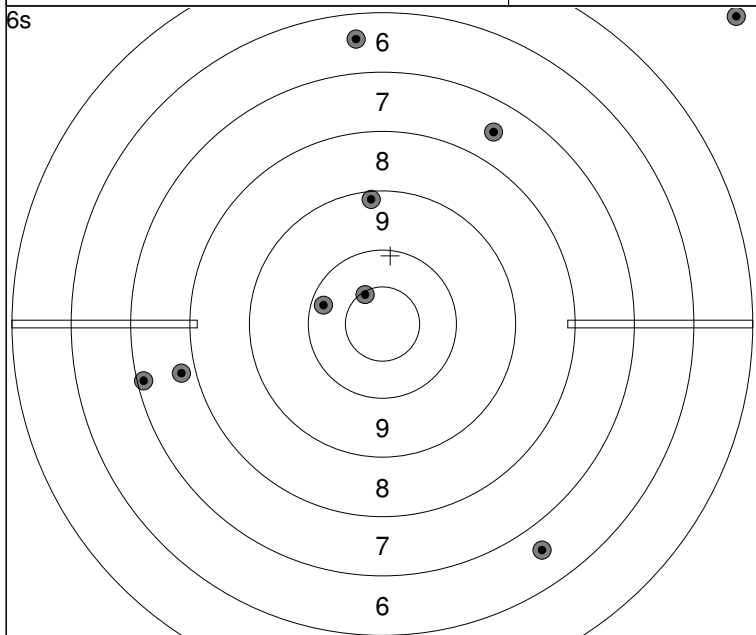

4: 2.45s 6.6 ↘
3: 3.66s 10.2 ←
2: 4.61s 7.1 ←
1: 5.23s 0.0 ↗
5: 1.96s 6.4 ↑

4: 3.03s 7.8 ←
3: 3.89s 10.5x ↗
2: 4.68s 9.2 ↑
1: 5.63s 7.5 ↗

Series	62 (1x)
	142 (1x)

5: 1.73s 7.8 ←
4: 2.35s 9.1 ←
3: 3.04s 6.3 ↘
2: 3.74s 6.1 ↙
1: 0.09s 7.4 ↘

5: 1.55s 0.0 ←
4: 2.29s 10.3 ↖
3: 2.92s 7.6 ↘
2: 3.52s 8.8 ←
1: 3.96s 7.6 ↗

Series	60 (0x)
	202 (1x)

Sight 8S 	50.00s 9.4 ↑ 44.28s 7.6 ↖ 35.46s 10.3 ↗ 26.55s 9.1 ↗ 17.53s 9.8 ↖ <hr/> Series 44 (0x) 0 (0x)	8s 	50.00s 9.8 → 44.51s 9.2 ↖ 35.50s 10.3 ← 26.55s 9.8 ↖ 17.58s 9.8 → 44.43s 7.8 ↗ 35.65s 9.0 ← 26.64s 9.9 ↑ 17.57s 8.3 ↓ 50.02s 9.5 ↗ <hr/> Series 88 (0x) 88 (0x)
6s 	50.02s 10.1 ↑ 43.73s 8.3 ↓ 34.59s 9.7 ↗ 25.44s 9.2 ↓ 16.29s 10.0 ↖ 10.00s 10.6 43.49s 9.3 ↓ 34.38s 9.6 ↓ 25.12s 10.2 ← 15.82s 10.2 ↖ <hr/> Series 94 (0x) 182 (0x)	Sh.off 6S 	50.35s 8.6 ↓ 42.94s 10.5x ↖ 34.00s 9.8 ↓ 24.94s 9.3 ↖ 15.97s 8.5 ↓ <hr/> Series 44 (1x) 182 (0x)
4s 	10.00s 9.4 42.39s 7.8 ↓ 32.94s 8.8 ↓ 23.43s 8.4 ↓ 13.89s 10.2 ↗ 50.00s 10.4 ↗ 42.25s 9.6 ↓ 32.81s 9.7 ↓ 23.31s 10.6x ↖ 13.75s 9.6 ← <hr/> Series 89 (1x) 271 (1x)		

Relay 3	Lane 18	ZHANG Ruopeng
-------------------	-------------------	----------------------

AHA Provincials	BC	SR	MP
-----------------	----	----	----

06.06.2026	2026 AB ISSF RF S2	Alberta Handgun Association
------------	--------------------	-----------------------------

Comment	Signature
---------	-----------

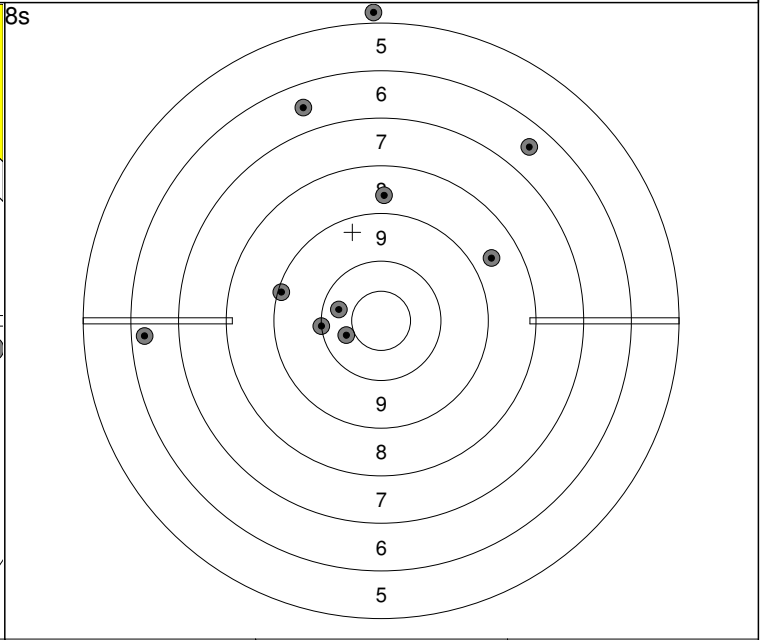
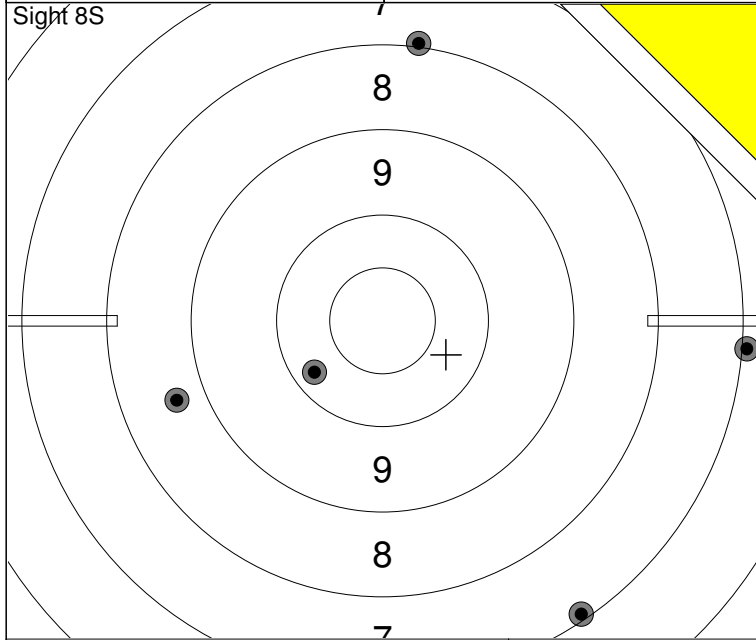

5: 2.00s	10.2	↙
4: 2.93s	8.7	↙
3: 3.97s	8.0	↑
2: 4.89s	7.0	→
1: 5.79s	7.1	↘

Series	40 (0x)
Series	0 (0x)

5: 1.92s	8.6	↗
4: 2.96s	10.3	↖
3: 4.00s	6.5	↗
2: 4.99s	6.5	↖
1: 5.92s	0.0	↑

5: 2.23s	10.3	↖
4: 3.33s	9.1	↖
3: 4.33s	6.3	↖
2: 5.35s	10.0	↖
1: 6.37s	8.6	↑

Series	73 (0x)
Series	73 (0x)

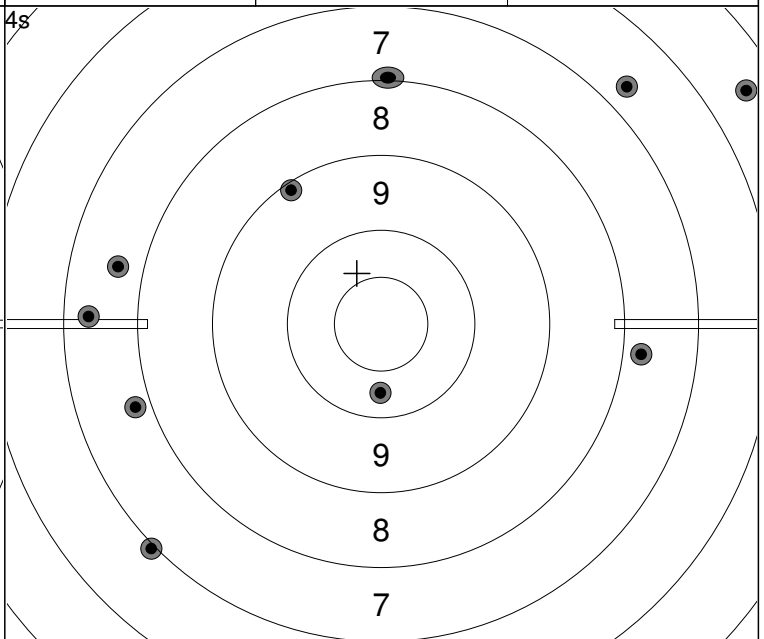
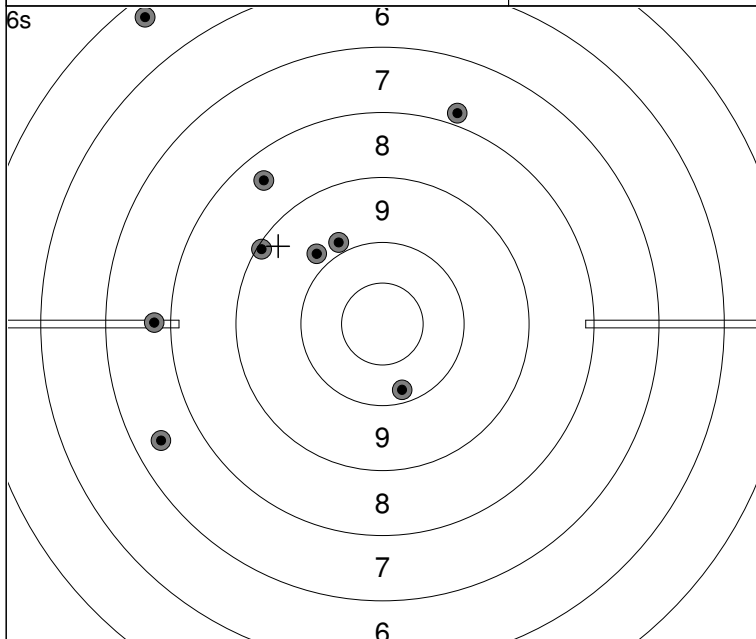

5: 1.61s	7.4	↖
4: 2.49s	10.2	↘
3: 3.39s	9.8	↗
2: 4.46s	7.8	↗
1: 5.32s	9.8	↖

5: 2.06s	7.8	↖
4: 3.14s	9.1	↖
1: 0.00s	0.0	
2: 4.95s	8.4	↗
1: 5.76s	5.3	↗

Series	71 (0x)
Series	144 (0x)

5: 1.73s	10.3	↓
4: 2.61s	7.8	↖
3: 3.36s	7.0	↘
2: 4.01s	6.7	↗
1: 0.33s	↘	

5: 1.64s	7.8	→
4: 2.33s	7.7	↖
3: 2.96s	7.4	↖
2: 3.53s	5.5	↗
1: 4.10s	9.1	↖

Series	65 (0x)
Series	209 (0x)