

Relay **1** Lane **3** **KIEJKO Lynda**

AHA Maple Leaf Open AB SR WP

03.05.2026 2026 AHA MLO MTP Alberta Handgun Association

Comment Signature

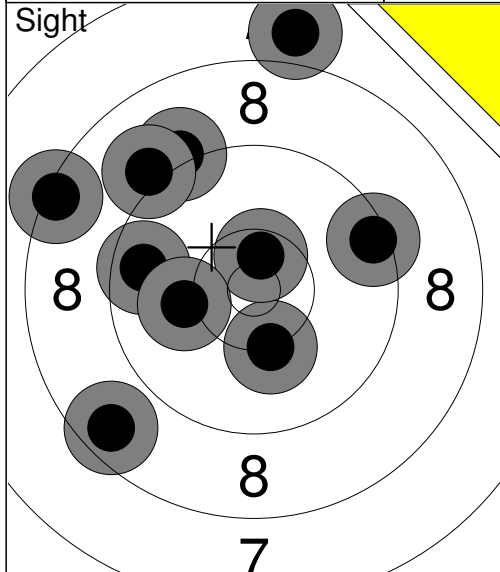

1:	10.2	↓
2:	9.1	↗
3:	8.6	↙
4:	8.4	↖
5:	9.1	↗
6:	9.4	→
7:	7.9	↑
8:	10.5x	↑
9:	9.6	←
10:	10.1	←
Series	89 (1x)	
	0 (0x)	

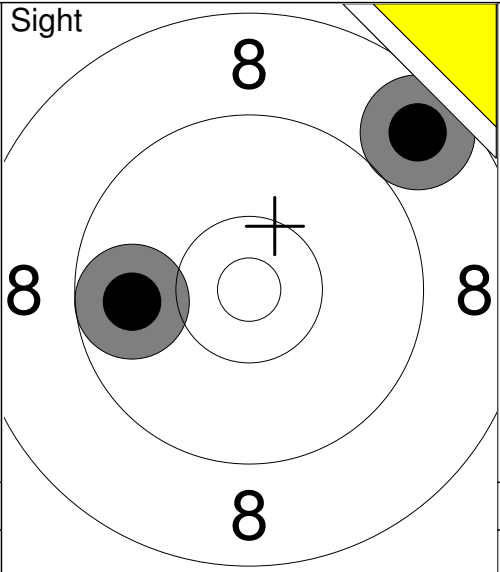

11:	8.7	↗
12:	9.8	←
Series	17 (0x)	
	0 (0x)	

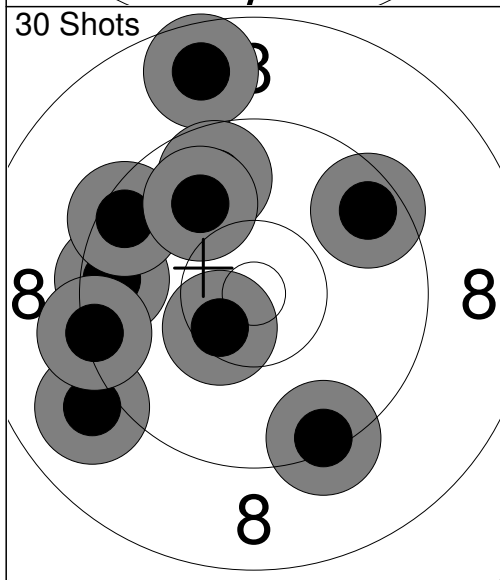

1:	9.5	←
2:	9.0	↙
3:	9.6	↗
4:	9.5	↖
5:	8.7	↑
6:	9.7	↗
7:	9.9	↗
8:	9.3	←
9:	10.5x	↙
10:	9.4	↓
Series	90 (1x)	
	90 (1x)	

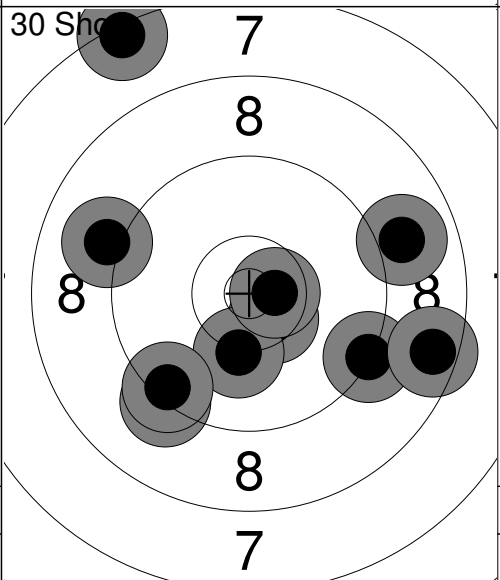

11:	8.9	→
12:	7.4	↗
13:	9.1	←
14:	9.2	↙
15:	10.5x	↘
16:	9.3	↘
17:	10.2	↓
18:	9.4	↙
19:	8.5	→
20:	10.6x	→
Series	89 (2x)	
	179 (3x)	

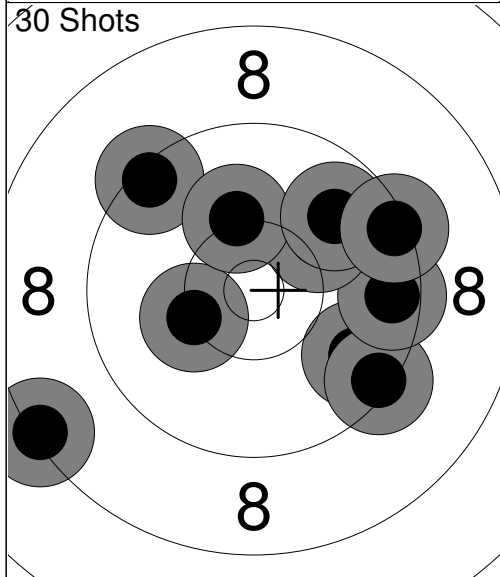

21:	10.3	←
22:	9.7	↘
23:	9.4	↘
24:	9.4	↗
25:	9.5	→
26:	10.1	↗
27:	10.2	↑
28:	9.8	↗
29:	8.3	↙
30:	9.4	→
Series	92 (0x)	
	271 (3x)	

Relay 1	Lane 4	ZHANG Da tian
-------------------	------------------	----------------------

AHA Maple Leaf Open	BC	SR	MP
---------------------	----	----	----

03.05.2026	2026 AHA MLO MTP	Alberta Handgun Association
------------	------------------	-----------------------------

Comment	Signature
---------	-----------

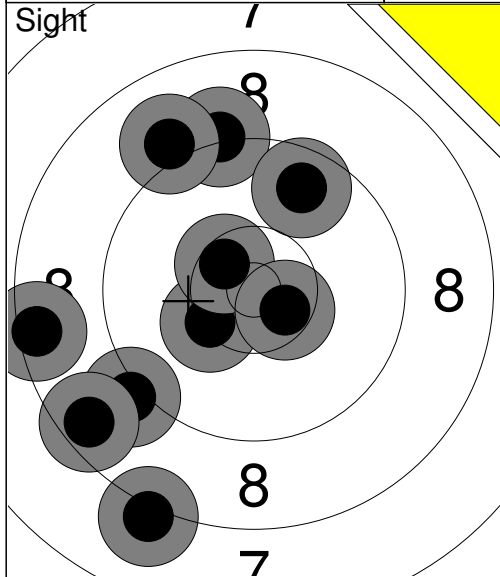

1:	9.2	↑
2:	9.7	↑
3:	10.3	↙
4:	8.4	←
5:	9.1	↙
6:	9.0	↑
7:	10.5x	↗
8:	10.5x	↘
9:	8.1	↘
10:	8.6	↙
Series	90 (2x)	
	0 (0x)	

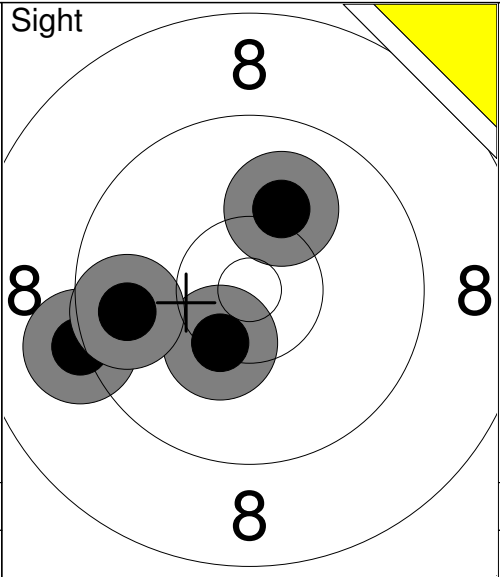

11:	10.1	↑
12:	9.2	←
13:	10.4	↘
14:	9.7	←
Series	38 (0x)	
	0 (0x)	

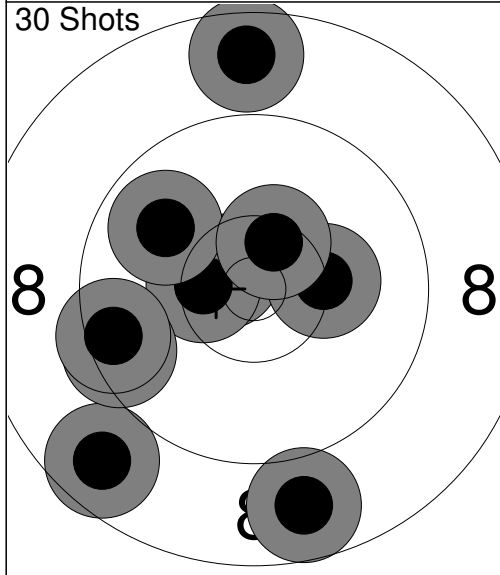

1:	10.6x	↖
2:	8.7	↘
3:	10.5x	←
4:	10.3	→
5:	9.9	↖
6:	9.5	←
7:	10.5x	↑
8:	9.5	←
9:	8.8	↘
10:	8.6	↑
Series	91 (3x)	
	91 (3x)	

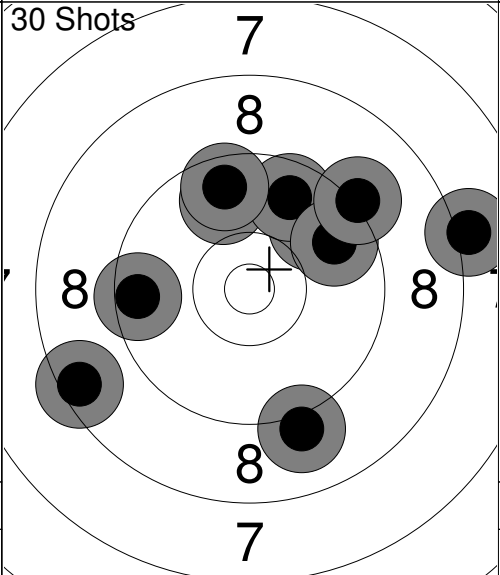

11:	9.1	↘
12:	9.5	←
13:	9.8	↗
14:	8.1	→
15:	8.5	←
16:	9.8	↑
17:	9.7	↑
18:	9.7	↗
19:	9.2	↗
20:	9.6	↑
Series	88 (0x)	
	179 (3x)	

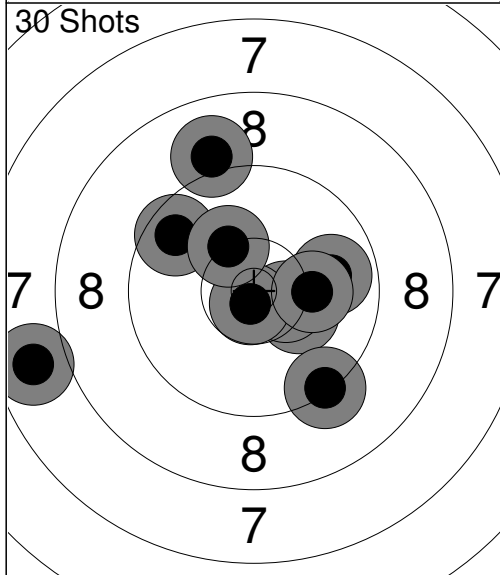

21:	10.3	↘
22:	7.8	←
23:	9.3	↘
24:	9.9	→
25:	10.5x	↘
26:	10.8x	↘
27:	9.6	↖
28:	9.0	↑
29:	10.2	↑
30:	10.2	→
Series	93 (2x)	
	272 (5x)	

Relay 1	Lane 5	CHEN Jia jia
-------------------	------------------	---------------------

AHA Maple Leaf Open	BC	JR	WP
---------------------	----	----	----

03.05.2026	2026 AHA MLO MTP	Alberta Handgun Association
------------	------------------	-----------------------------

Comment	Signature
---------	-----------

<p>Sight</p>	<p>1: 10.0 ↑ 2: 9.5 ↖ 3: 10.4x → 4: 9.1 ↑ 5: 8.6 ↓ 6: 8.0 ↗ 7: 9.8 ↖ 8: 10.8x ↑ 9: 9.0 ↓ 10: 7.9 →</p> <p>Series 89 (2x) 0 (0x)</p>	<p>Sight</p> <p>11: 8.0 ↓ 12: 8.5 ↑</p> <p>Series 16 (0x) 0 (0x)</p>
--------------	---	--

<p>30 Shots</p>	<p>1: 10.5x ↖ 2: 8.3 ↗ 3: 10.4x ↑ 4: 8.3 ↓ 5: 8.0 → 6: 10.2 → 7: 7.9 ↓ 8: 9.0 ↑ 9: 10.5x → 10: 7.6 →</p> <p>Series 87 (3x) 87 (3x)</p>	<p>30 Shots</p> <p>11: 9.7 ↓ 12: 7.3 ↗ 13: 9.9 ↓ 14: 9.1 ↖ 15: 8.8 → 16: 9.0 ↓ 17: 10.4x ↑ 18: 9.9 ← 19: 7.8 → 20: 7.2 ↓</p> <p>Series 84 (1x) 171 (4x)</p>
-----------------	--	---

<p>30 Shots</p>	<p>21: 9.8 → 22: 8.9 ↓ 23: 10.5x → 24: 9.5 → 25: 7.9 ↓ 26: 8.0 ← 27: 9.0 ↑ 28: 8.6 ↓ 29: 9.9 ↗ 30: 7.5 ↓</p> <p>Series 84 (1x) 255 (5x)</p>	
-----------------	---	--

Comment	Signature		
---------	-----------	--	--

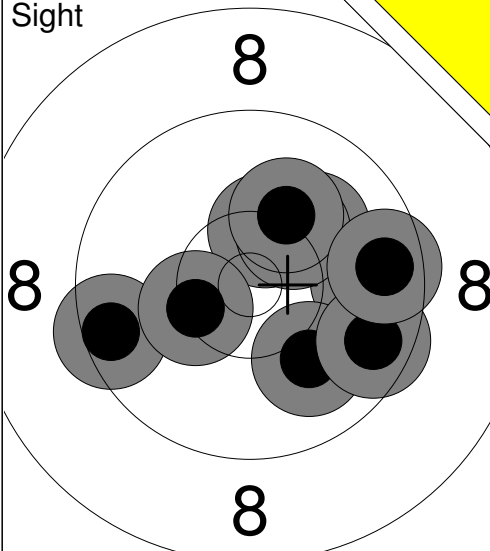
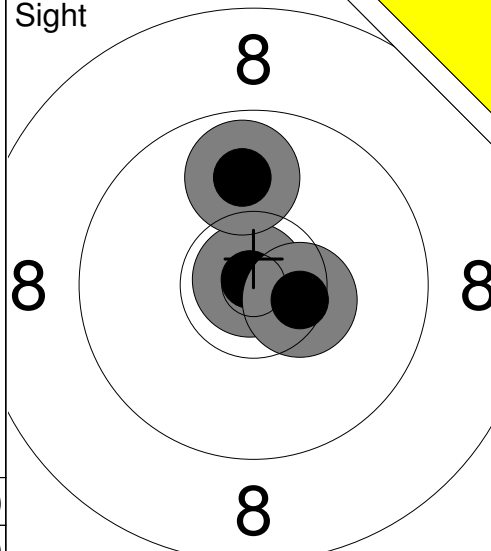
<p>Sight</p> 	<p>1: 10.1 ↗ 2: 10.4x ↑ 3: 9.8 → 4: 9.5 ← 5: 10.3 ↗ 6: 10.0 ↓ 7: 9.6 ⇒ 8: 10.2 ↑ 9: 10.4x ← 10: 9.6 →</p> <p>Series 96 (2x) 0 (0x)</p>	<p>Sight</p> 	<p>11: 10.9x ↖ 12: 9.9 ↑ 13: 10.5x ⇒</p> <p>Series 29 (2x) 0 (0x)</p>
---	--	---	---

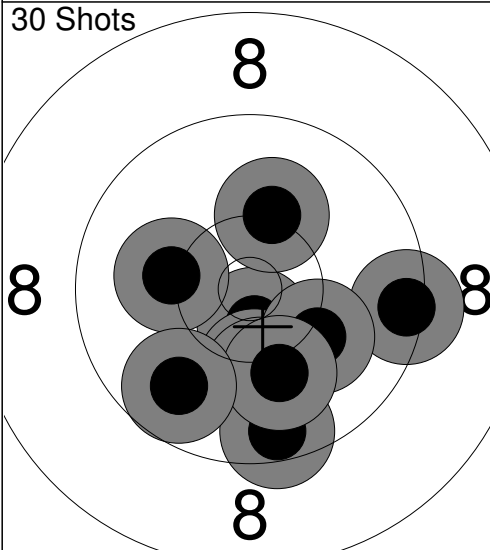
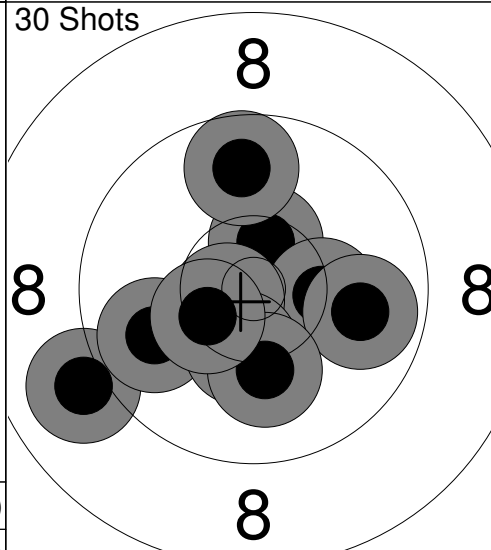
<p>30 Shots</p> 	<p>1: 9.4 → 2: 10.6x ↓ 3: 10.2 ↓ 4: 10.1 ↓ 5: 9.5 ↓ 6: 10.1 ⇒ 7: 10.2 ↑ 8: 10.1 ↓ 9: 10.2 ← 10: 9.8 ↓</p> <p>Series 97 (1x) 97 (1x)</p>	<p>30 Shots</p> 	<p>11: 9.0 ← 12: 10.5x ↑ 13: 9.9 ← 14: 10.3 ⇒ 15: 9.8 ↑ 16: 9.9 ⇒ 17: 10.7x ← 18: 10.4 ↓ 19: 10.1 ↓ 20: 10.4x ↙</p> <p>Series 96 (3x) 193 (4x)</p>
---	---	---	--

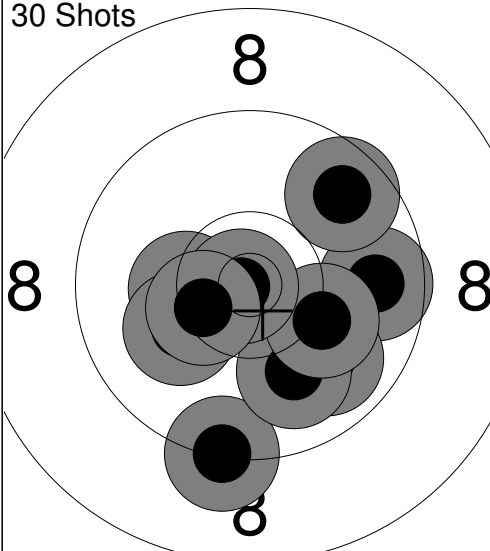
<p>30 Shots</p> 	<p>21: 10.3 ← 22: 9.3 ↓ 23: 9.7 → 24: 9.7 ↗ 25: 10.1 ← 26: 9.9 ↓ 27: 10.0 ↓ 28: 10.2 ⇒ 29: 10.9x ← 30: 10.4x ↙</p> <p>Series 96 (2x) 289 (6x)</p>		
--	---	--	--

Relay 1	Lane 7	LI Wenhan
-------------------	------------------	------------------

AHA Maple Leaf Open	BC	JR	WP
---------------------	----	----	----

03.05.2026	2026 AHA MLO MTP	Alberta Handgun Association
------------	------------------	-----------------------------

Comment	Signature
---------	-----------

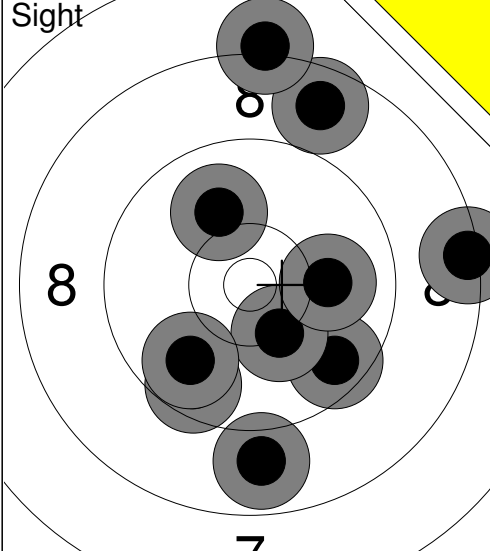
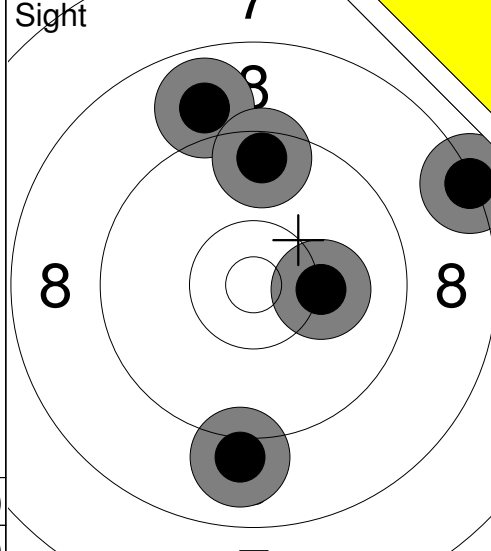
<p>Sight</p> 	<p>Sight</p> 	<p>11: 9.0 ↓</p> <p>12: 8.9 ↑</p> <p>13: 9.5 ↑</p> <p>14: 8.3 →</p> <p>15: 10.2 →</p> <p>Series 44 (0x)</p> <p>0 (0x)</p>
---	---	---

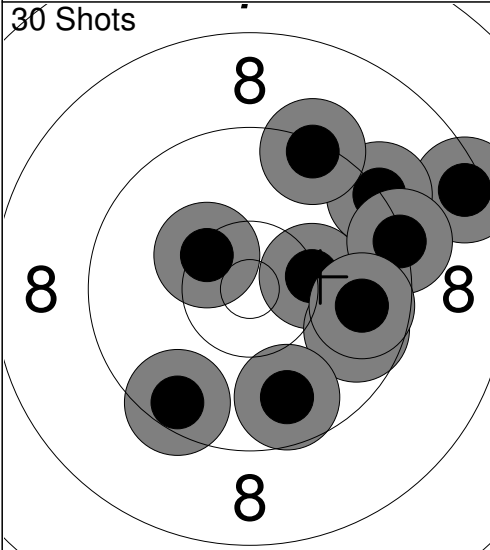
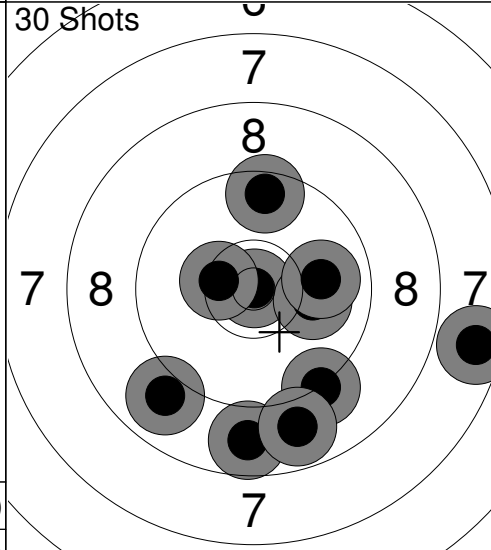
<p>30 Shots</p> 	<p>30 Shots</p> 	<p>11: 8.7 ↓</p> <p>12: 9.2 ↓</p> <p>13: 8.9 ↓</p> <p>14: 10.9x ↗</p> <p>15: 10.4x ←</p> <p>16: 7.6 →</p> <p>17: 8.9 ↓</p> <p>18: 10.1 →</p> <p>19: 10.0 →</p> <p>20: 9.6 ↑</p> <p>Series 89 (2x)</p> <p>180 (3x)</p>
---	---	---

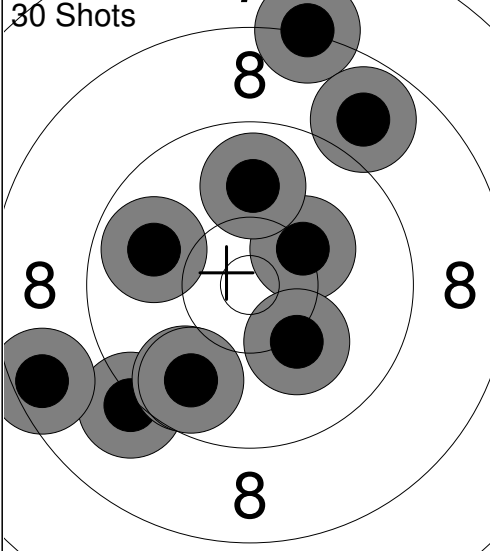
<p>30 Shots</p> 		<p>21: 9.2 ↓</p> <p>22: 9.9 ←</p> <p>23: 8.5 ←</p> <p>24: 10.3 →</p> <p>25: 10.2 ↓</p> <p>26: 9.9 ↑</p> <p>27: 9.7 ↓</p> <p>28: 8.2 ↑</p> <p>29: 8.8 ↗</p> <p>30: 9.8 ↓</p> <p>Series 89 (0x)</p> <p>269 (3x)</p>
--	--	---

Relay **1** Lane **8** **ZHANG Zhuang**

AHA Maple Leaf Open BC SR MP

03.05.2026 2026 AHA MLO MTP Alberta Handgun Association

Comment Signature

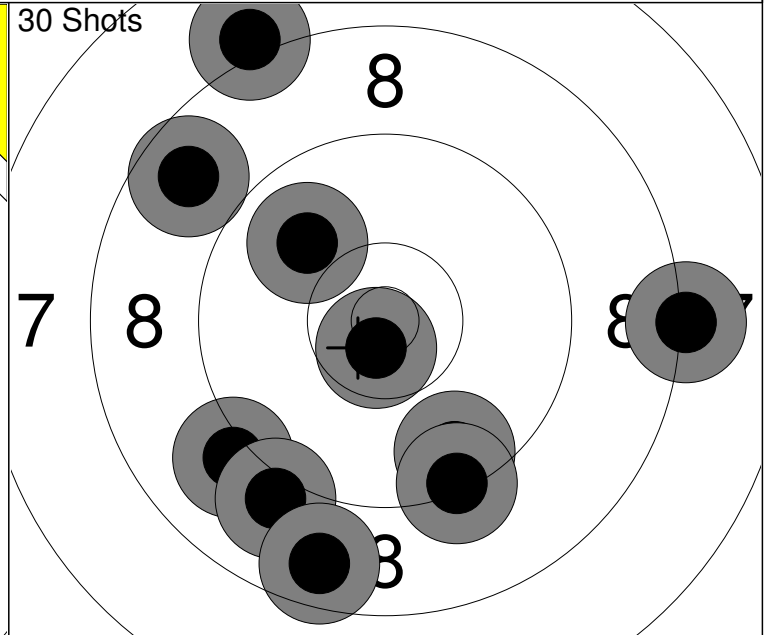
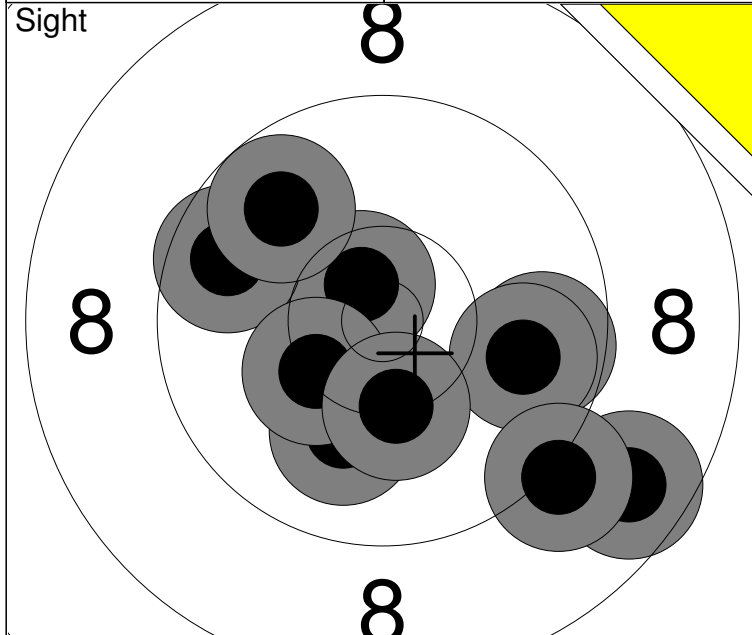

1: 10.6x ↗	6: 10.1 ↓	Series 93 (1x)
2: 9.7 →	7: 10.3 ↘	
3: 8.7 ↘	8: 9.2 ↘	0 (0x)
4: 9.8 ↘	9: 9.8 ↗	
5: 9.7 ↗	10: 10.3 ↓	

1: 8.2 →	6: 9.0 ↘	Series 87 (1x)
2: 8.1 ↗	7: 9.9 ↗	
3: 9.1 ↘	8: 10.7x ↘	87 (1x)
4: 8.7 ↗	9: 8.6 ↓	
5: 9.6 ↓	10: 9.3 ↓	

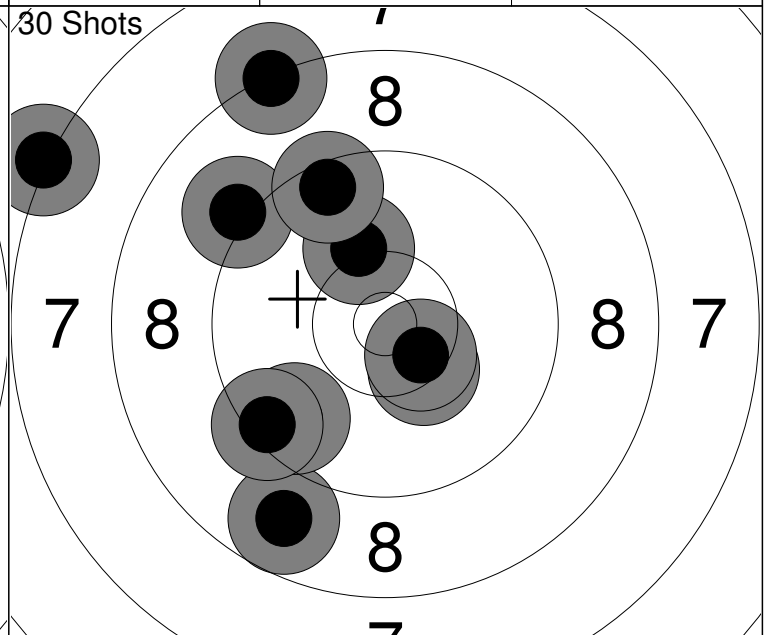
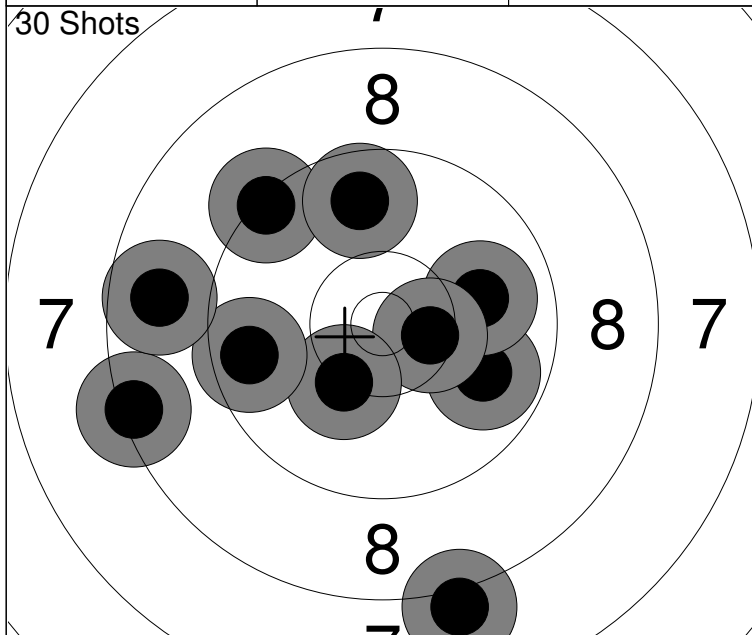

11: 8.1 ↓	16: 10.3 ↘	Series 90 (1x)
12: 9.9 ↘	17: 9.3 ↗	
13: 10.0 →	18: 9.7 ↗	177 (2x)
14: 8.4 ←	19: 9.6 ←	
15: 10.5x →	20: 8.7 ←	

21: 8.8 ↓	26: 10.2 ↗	Series 89 (1x)
22: 10.4 ↘	27: 9.4 ↘	
23: 9.7 ↘	28: 9.5 ↗	266 (3x)
24: 10.5x ↘	29: 8.3 ↗	
25: 9.1 ↗	30: 7.2 ←	

Relay 1	Lane 9	WANG Christine
-------------------	------------------	-----------------------

AHA Maple Leaf Open	BC	JR	WP
---------------------	----	----	----

03.05.2026	2026 AHA MLO MTP	Alberta Handgun Association
------------	------------------	-----------------------------

Comment	Signature
---------	-----------

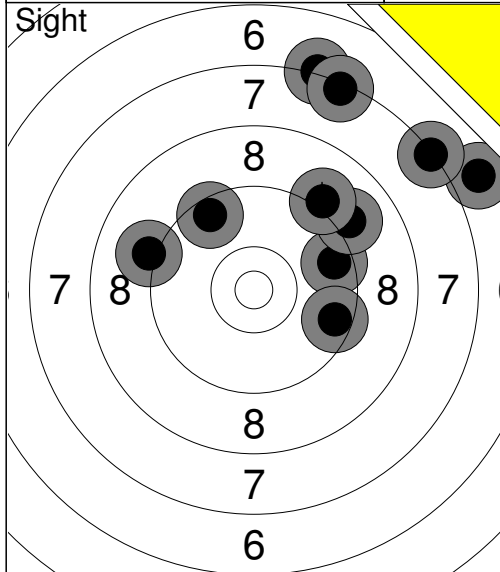

1:	7.2	↑
2:	7.3	↑
3:	9.5	→
4:	9.1	←
5:	9.0	↗
6:	9.1	↗
7:	9.5	→
8:	6.8	→
9:	9.5	↖
10:	7.3	↗
Series	81 (0x)	
	0 (0x)	

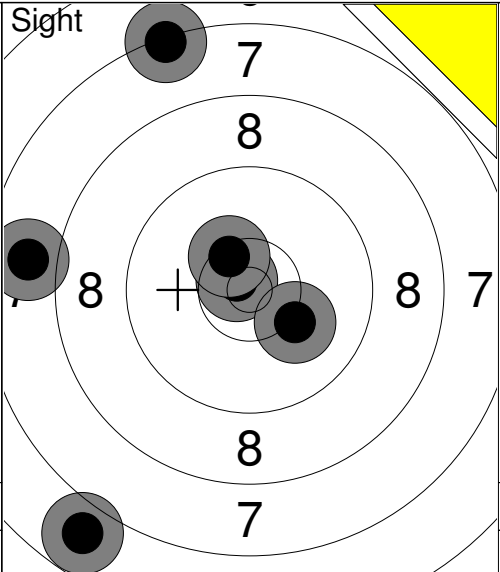

11:	6.8	↘
12:	10.7x	↖
13:	7.8	←
14:	7.3	↑
15:	10.2	↘
16:	10.4x	↖
Series	50 (2x)	
	0 (0x)	

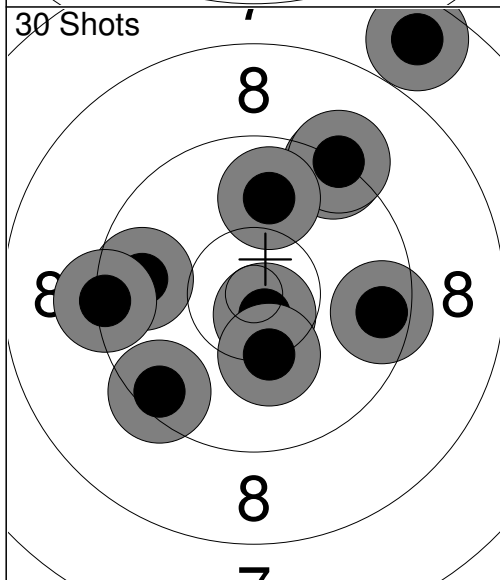

1:	9.3	↗
2:	9.2	↗
3:	10.7x	↘
4:	9.5	↘
5:	7.7	↗
6:	9.9	↑
7:	9.7	←
8:	9.6	→
9:	9.3	←
10:	10.3	↘
Series	90 (1x)	
	90 (1x)	

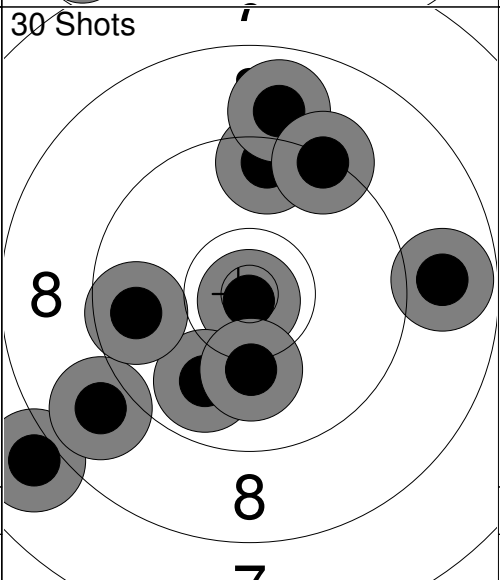

11:	10.9x	↘
12:	9.9	↘
13:	9.5	↑
14:	8.0	↘
15:	10.1	↘
16:	8.9	↘
17:	8.9	↑
18:	9.3	↗
19:	9.7	←
20:	8.8	→
Series	88 (1x)	
	178 (2x)	

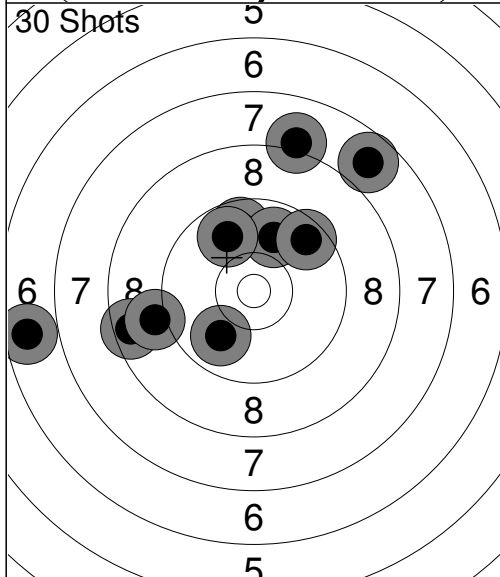

21:	7.8	↗
22:	9.7	↑
23:	9.9	↑
24:	6.7	←
25:	9.6	↗
26:	9.8	↖
27:	8.6	←
28:	9.0	←
29:	8.1	↑
30:	9.9	↘
Series	83 (0x)	
	261 (2x)	

Relay 1	Lane 10	NEIL Jaden
-------------------	-------------------	-------------------

AHA Maple Leaf Open	AB	SR	MP
---------------------	----	----	----

03.05.2026	2026 AHA MLO MTP	Alberta Handgun Association
------------	------------------	-----------------------------

Comment	Signature
---------	-----------

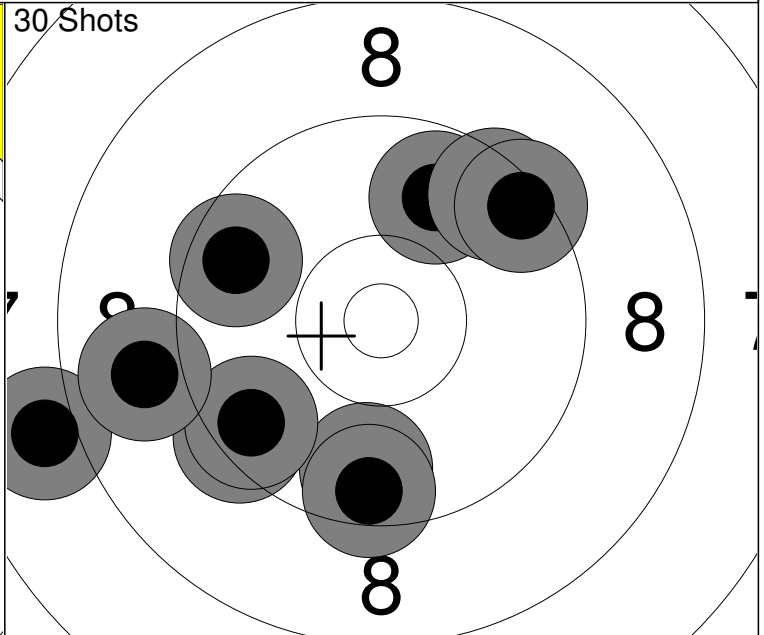
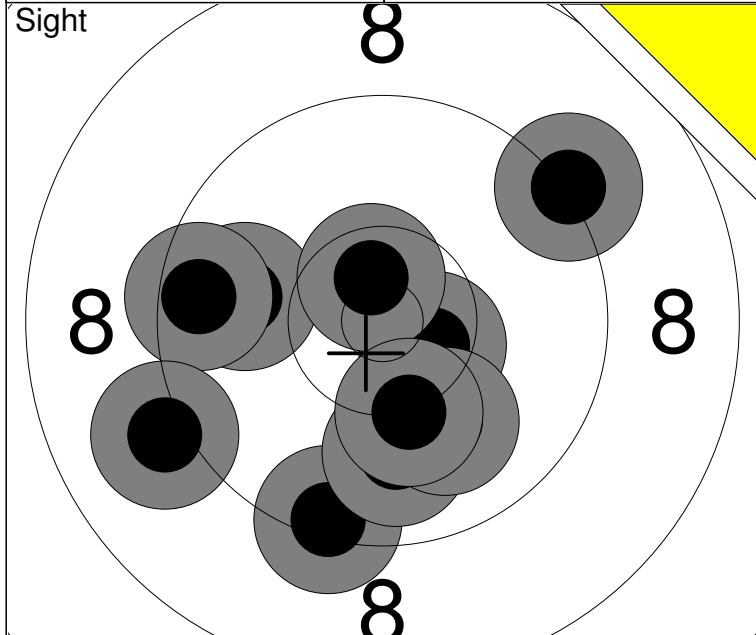

1: 9.9 ←	6: 9.4 ↓	Series	94 (2x)
2: 9.2 ↗	7: 9.9 ↓		
3: 9.5 ←	8: 10.6x ↑		0 (0x)
4: 10.5x →	9: 10.0 ↓		
5: 9.1 ←	10: 10.2 ↓		

1: 9.8 ↗	6: 9.6 ←	Series	88 (0x)
2: 8.0 ←	7: 9.4 ↙		
3: 9.5 ↗	8: 9.4 ↗		88 (0x)
4: 9.7 ↓	9: 9.6 ↙		
5: 9.5 ↓	10: 8.9 ←		

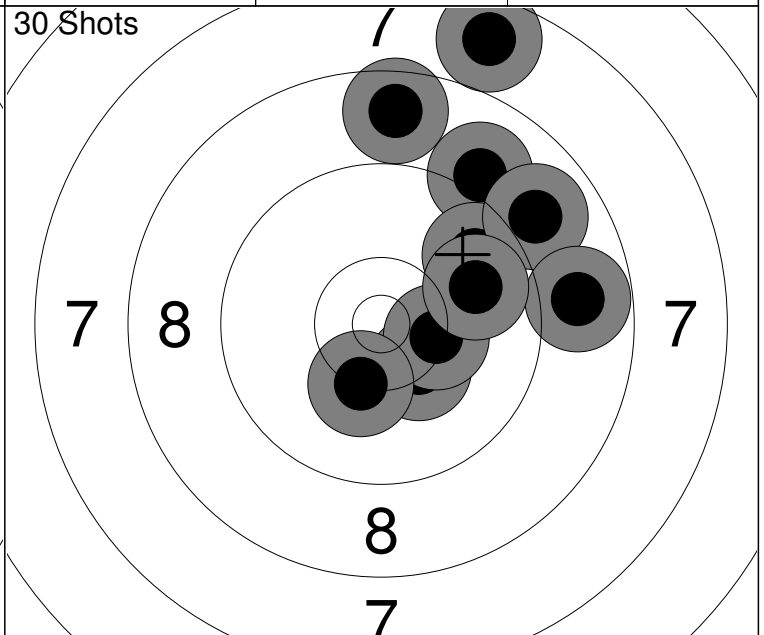
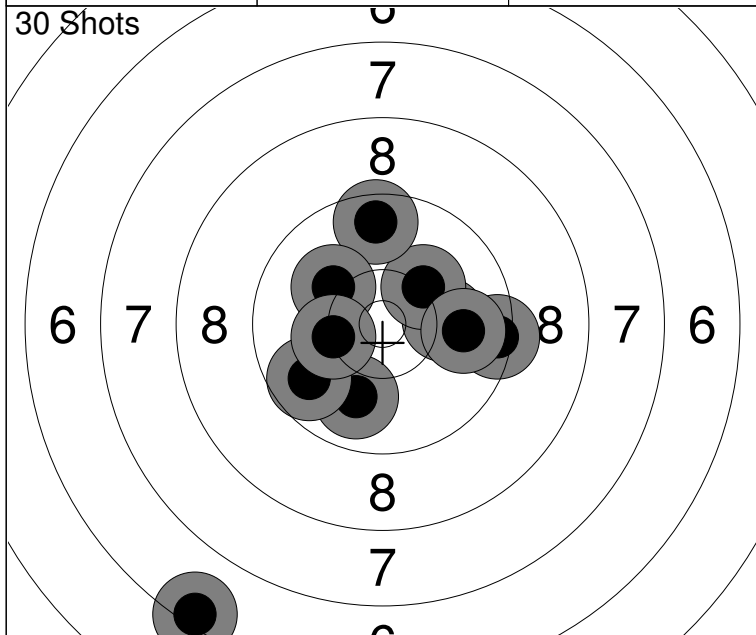

11: 6.4 ↙	16: 9.6 ↑	Series	91 (0x)
12: 10.1 →	17: 9.4 →		
13: 9.9 ↓	18: 10.1 ↗		179 (0x)
14: 10.2 ↗	19: 9.9 →		
15: 9.7 ←	20: 10.3 ←		

21: 9.0 ↗	26: 8.9 ↗	Series	88 (0x)
22: 9.7 ↗	27: 10.3 →		
23: 8.7 ↑	28: 8.8 →		267 (0x)
24: 7.7 ↑	29: 10.3 ↓		
25: 10.3 ↙	30: 9.9 →		

Relay **1** Lane **11** **BRAR Mahtab kaur**

AHA Maple Leaf Open AB JR WP

03.05.2026 2026 AHA MLO MTP Alberta Handgun Association

Comment Signature

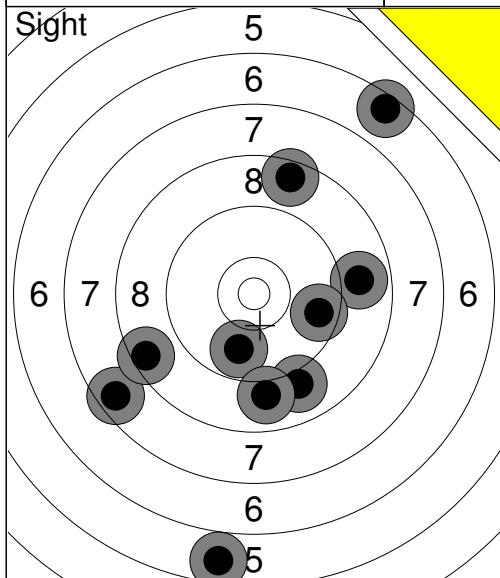

1:	8.6	↑
2:	9.0	↓
3:	7.6	←
4:	5.7	↓
5:	8.9	→
6:	8.5	←
7:	9.6	→
8:	9.8	↓
9:	6.5	↗
10:	8.9	↓
Series	77 (0x)	
	0 (0x)	

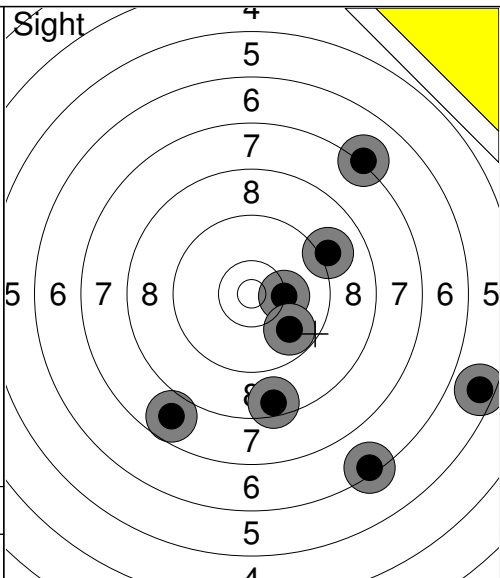

11:	6.4	↓
12:	5.5	↘
13:	10.2	→
14:	7.8	↓
15:	9.1	↗
16:	7.2	↗
17:	8.5	↓
18:	9.8	↓
Series	61 (0x)	
	0 (0x)	

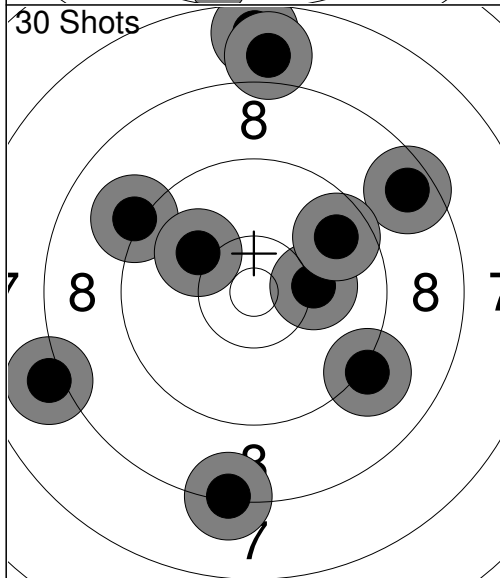

1:	7.6	↑
2:	8.6	↗
3:	9.1	←
4:	8.3	↓
5:	7.9	↑
6:	10.2	→
7:	9.2	↘
8:	10.1	↖
9:	9.7	↗
10:	8.1	←
Series	85 (0x)	
	85 (0x)	

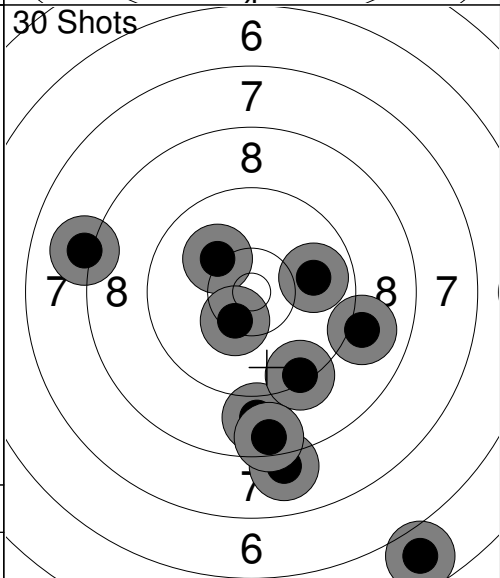

11:	9.9	→
12:	8.9	↓
13:	9.4	↓
14:	8.1	←
15:	10.2	↗
16:	10.4x	↓
17:	8.0	↓
18:	5.8	↓
19:	9.0	→
20:	8.5	↓
Series	84 (1x)	
	169 (1x)	

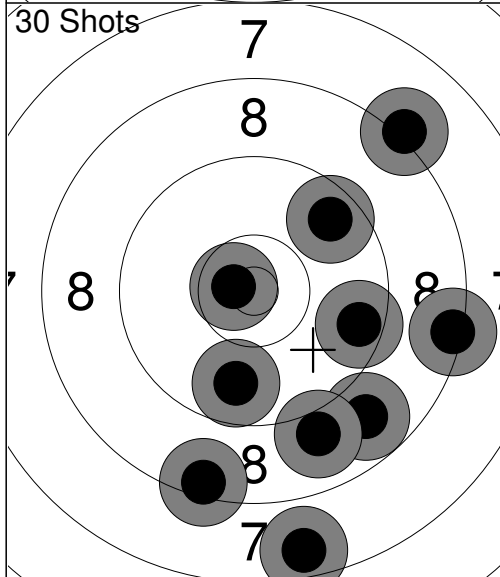

21:	8.8	↓
22:	7.6	↓
23:	9.5	→
24:	9.7	↓
25:	9.6	↗
26:	8.9	↓
27:	8.1	↗
28:	10.7x	←
29:	8.4	↓
30:	8.3	→
Series	84 (1x)	
	253 (2x)	

Relay 1	Lane 12	OZER Tugrul
-------------------	-------------------	--------------------

AHA Maple Leaf Open	AB	SR	MP
---------------------	----	----	----

03.05.2026	2026 AHA MLO MTP	Alberta Handgun Association
------------	------------------	-----------------------------

Comment	Signature
---------	-----------

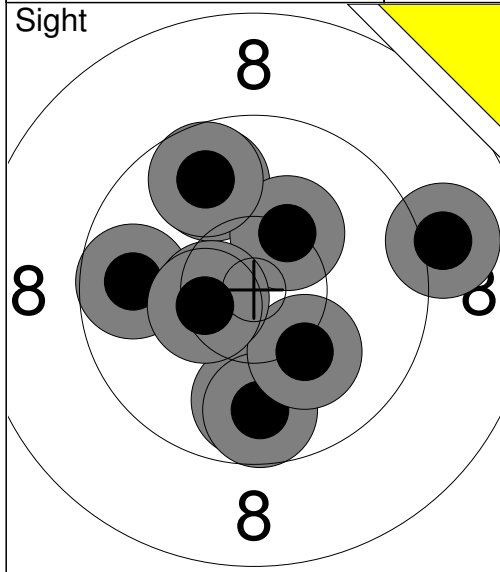

1:	9.8	←
2:	9.8	↑
3:	9.9	↓
4:	10.3	↗
5:	9.8	↓
6:	10.2	↘
7:	9.0	→
8:	10.5x	←
9:	10.4x	←
10:	9.8	↑
Series	94 (2x)	
	0 (0x)	

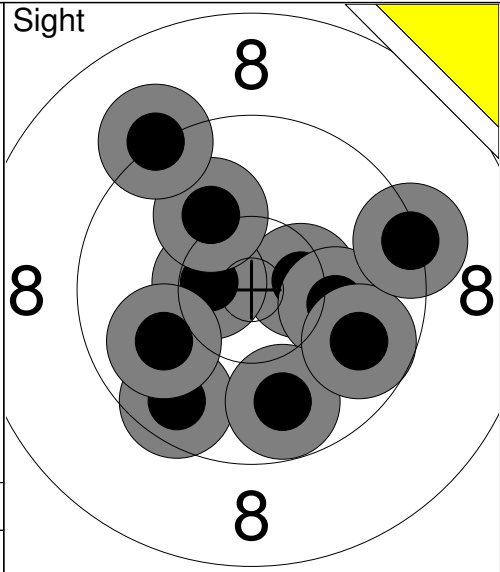

11:	10.5x	→
12:	10.5x	←
13:	10.1	↑
14:	9.2	↑
15:	10.1	→
16:	9.6	↓
17:	9.9	←
18:	9.8	↓
19:	9.8	→
20:	9.3	→
Series	94 (2x)	
	0 (0x)	

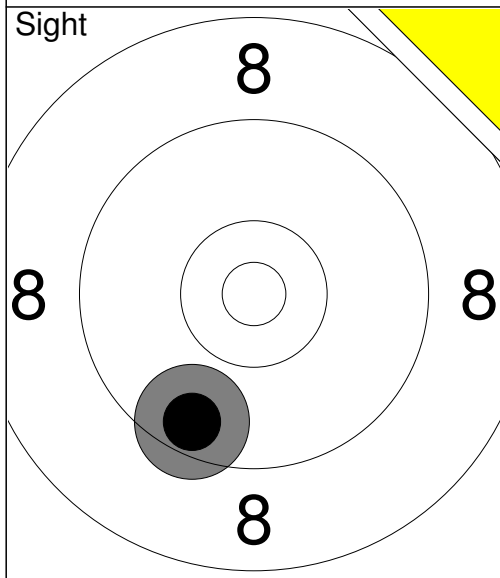

21:	9.6	↓
Series	9 (0x)	
	0 (0x)	

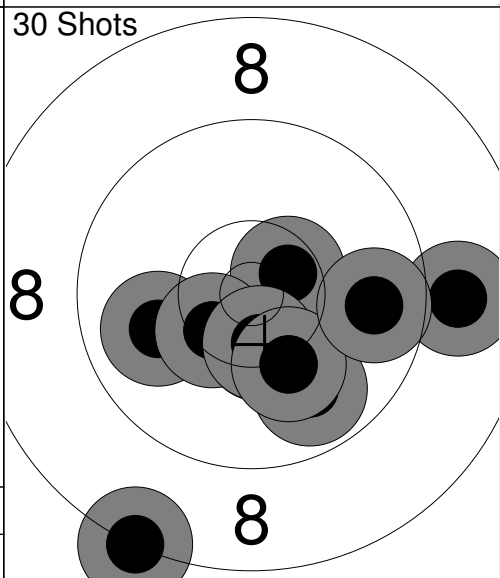

1:	8.9	→
2:	10.0	←
3:	9.9	↓
4:	10.5x	↓
5:	10.5x	↗
6:	8.2	↓
7:	10.4x	←
8:	10.5x	↓
9:	10.2	↓
10:	9.7	→
Series	94 (4x)	
	94 (4x)	

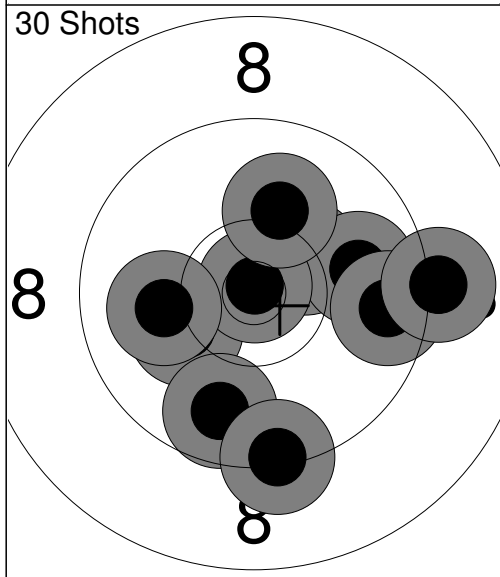

11:	10.3	↗
12:	10.2	←
13:	9.9	→
14:	10.9x	↑
15:	9.6	→
16:	9.7	↓
17:	9.3	↓
18:	9.1	→
19:	10.1	↑
20:	10.1	←
Series	95 (1x)	
	189 (5x)	

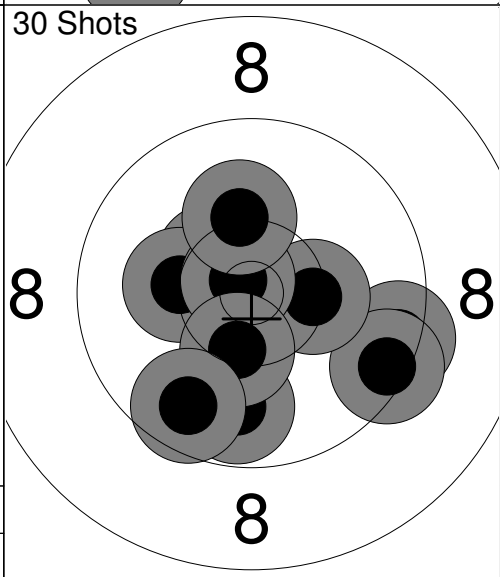

21:	10.5x	↖
22:	9.4	→
23:	9.8	↓
24:	9.4	→
25:	10.2	←
26:	10.4	→
27:	10.8x	↖
28:	10.2	↑
29:	10.4x	↓
30:	9.7	↓
Series	96 (3x)	
	285 (8x)	

Relay **1** Lane **13** **MOLBERG Emma**

AHA Maple Leaf Open SK JR WP

03.05.2026 2026 AHA MLO MTP Alberta Handgun Association

Comment Signature

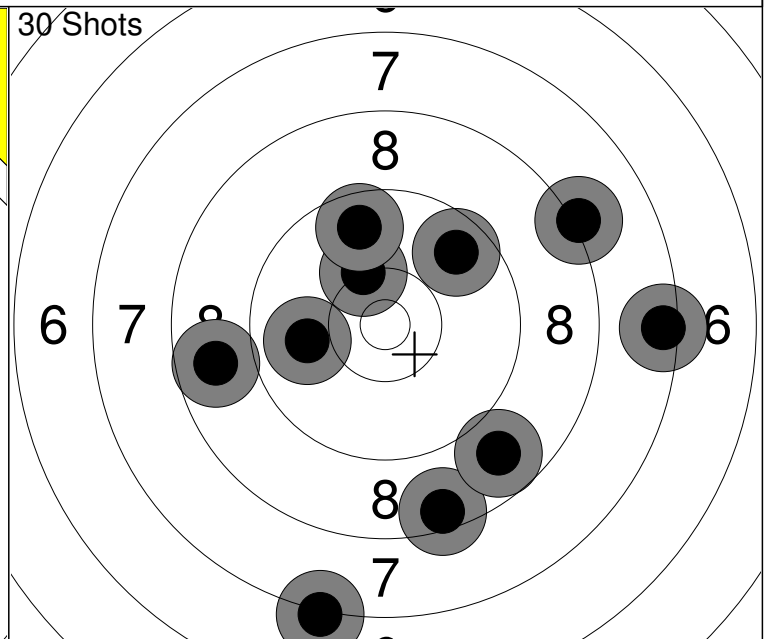
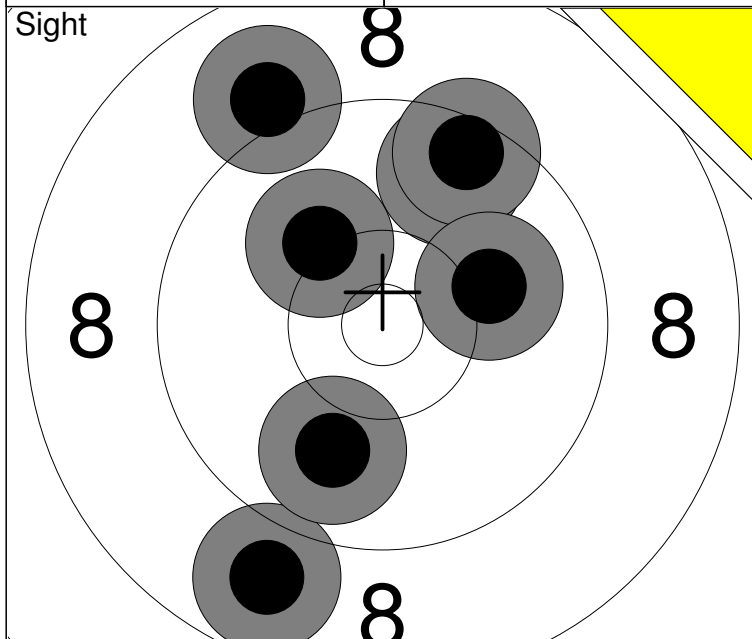

1: 8.8 ↓	6: 10.2 ↗	Series 64 (0x)
2: 9.7 ↗	7: 9.0 ↗	
3: 9.5 ↗		0 (0x)
4: 10.1 →		
5: 9.9 ↓		

1: 10.2 ↗	6: 7.4 →	Series 83 (0x)
2: 9.7 ↗	7: 8.7 ←	
3: 7.2 ↓	8: 8.5 ↓	83 (0x)
4: 8.2 →	9: 8.8 ↓	
5: 9.9 ←	10: 9.7 ↗	

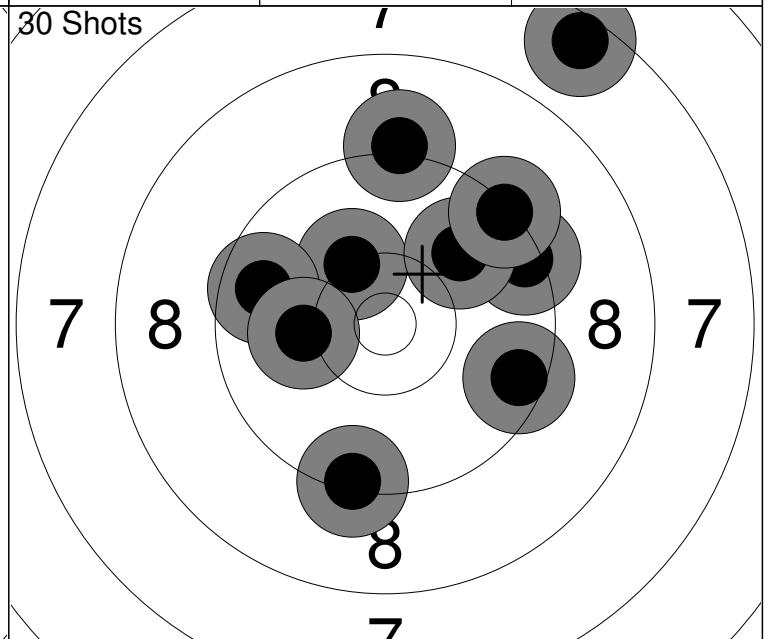
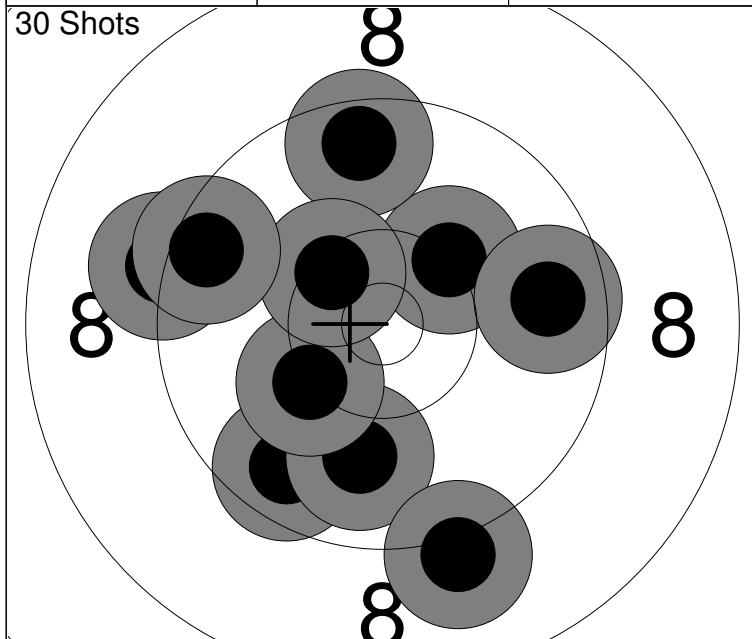

11: 10.2 ↗	16: 10.2 ←	Series 93 (1x)
12: 9.6 ↑	17: 10.4x ↗	
13: 9.7 →	18: 9.2 ←	176 (1x)
14: 9.6 ↓	19: 9.5 ↗	
15: 9.9 ↓	20: 9.1 ↓	

21: 10.3 ↗	26: 9.1 ↑	Series 90 (0x)
22: 9.7 ←	27: 9.5 →	
23: 7.5 ↗	28: 9.4 →	266 (1x)
24: 10.1 ←	29: 9.9 ↗	
25: 9.3 ↓	30: 9.3 ↗	

Relay 1	Lane 14	NORMAN Seth
-------------------	-------------------	--------------------

AHA Maple Leaf Open	SK	SR	MP
---------------------	----	----	----

03.05.2026	2026 AHA MLO MTP	Alberta Handgun Association
------------	------------------	-----------------------------

Comment	Signature
---------	-----------

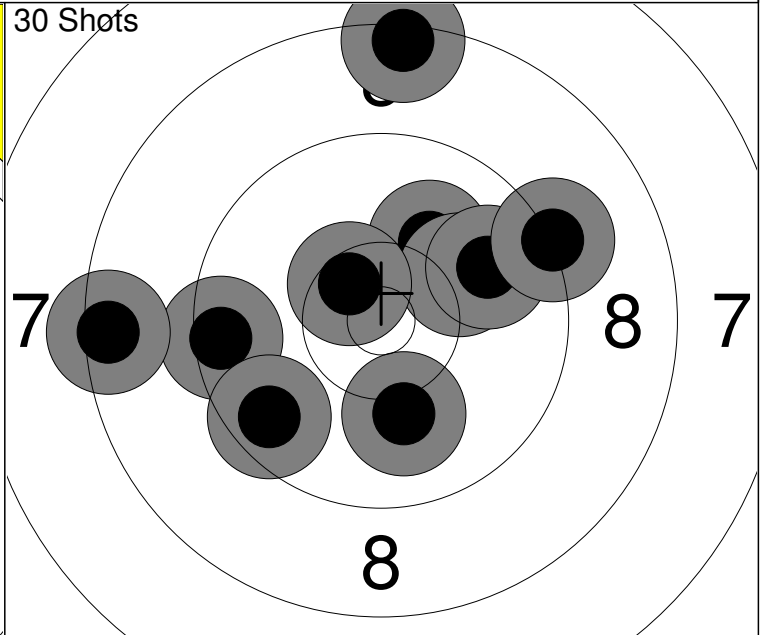
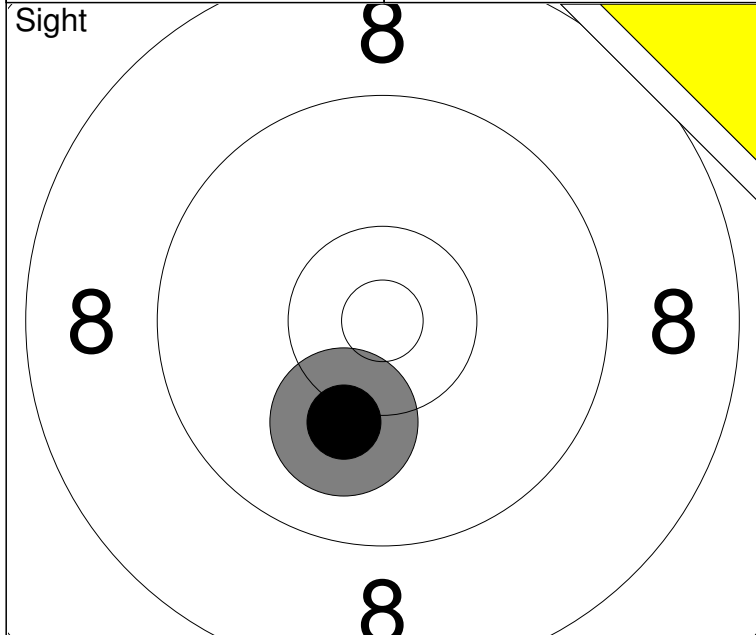

1: 10.1 ↓

Series	10 (0x)
Series	0 (0x)

1: 10.1 ↗	6: 10.5x ↖
2: 10.1 →	7: 8.4 ←
3: 9.5 ←	8: 9.9 →
4: 9.6 ↓	9: 8.4 ↑
5: 10.1 ↓	10: 9.2 →

Series	92 (1x)
Series	92 (1x)

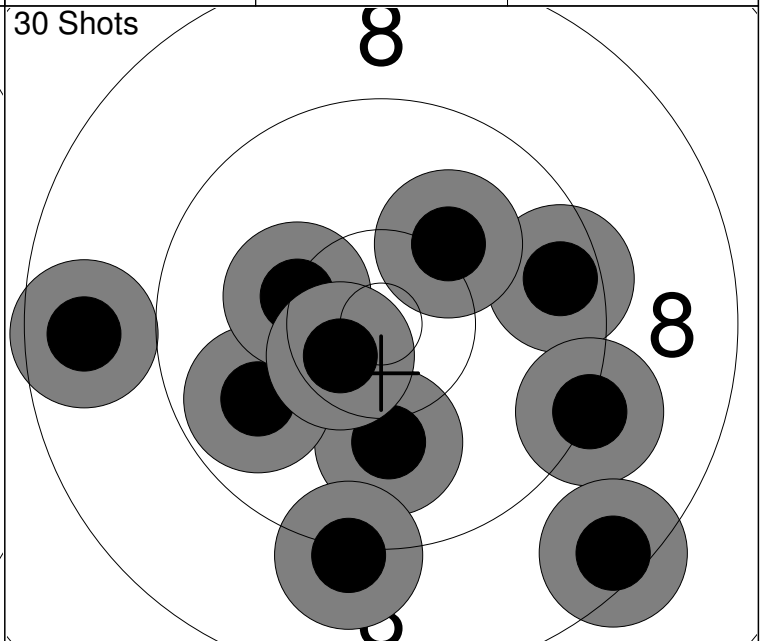
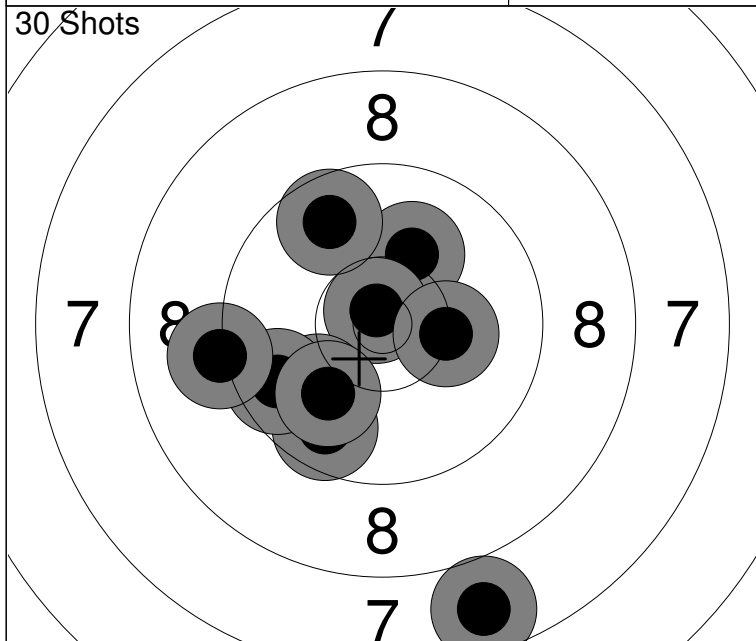

11: 9.7 ↓	16: 9.7 ←
12: 7.7 ↓	17: 10.3 →
13: 10.1 ↗	18: 10.0 ↓
14: 10.8x ↗	19: 9.7 ↗
15: 10.0 ↙	20: 9.2 ←

Series	93 (1x)
Series	185 (2x)

21: 9.5 →	26: 8.5 ↓
22: 8.7 ←	27: 9.2 ↓
23: 9.2 →	28: 10.3 ←
24: 10.0 ↓	29: 10.1 ↗
25: 9.9 ←	30: 10.6x ↙

Series	92 (1x)
Series	277 (3x)

Comment	Signature		
---------	-----------	--	--

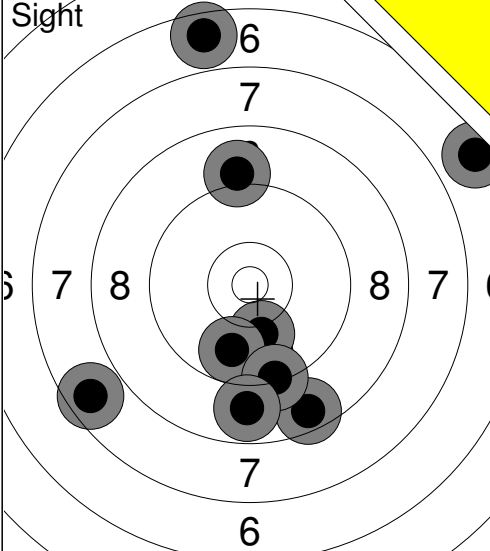
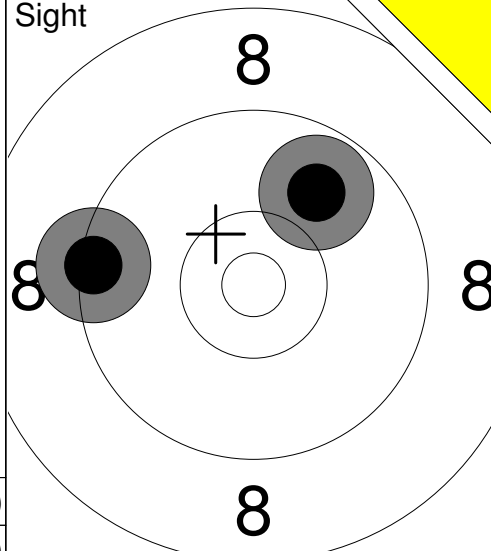
<p>Sight</p> 	<p>Sight</p> 	
---	---	--

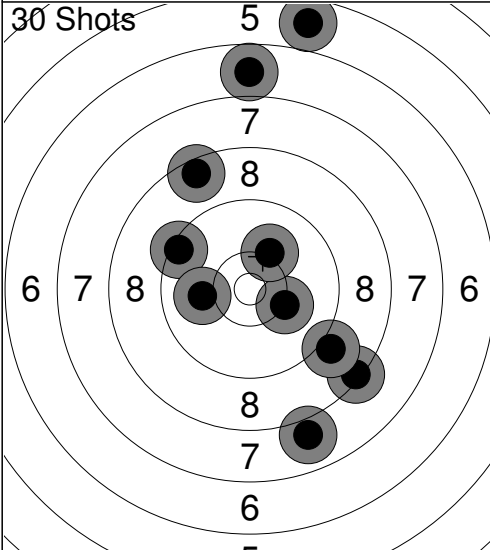
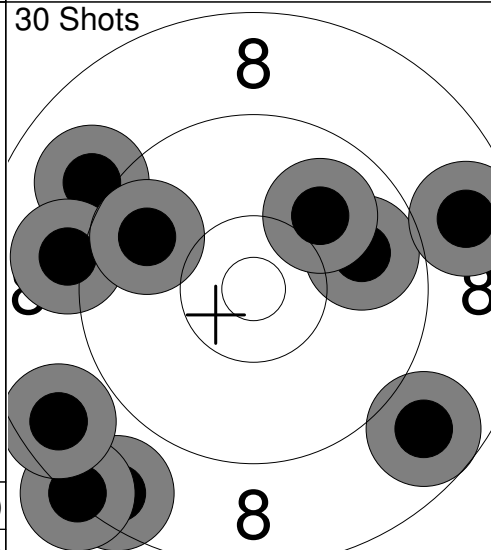
<p>30 Shots</p> 	<p>30 Shots</p> 	
---	---	--

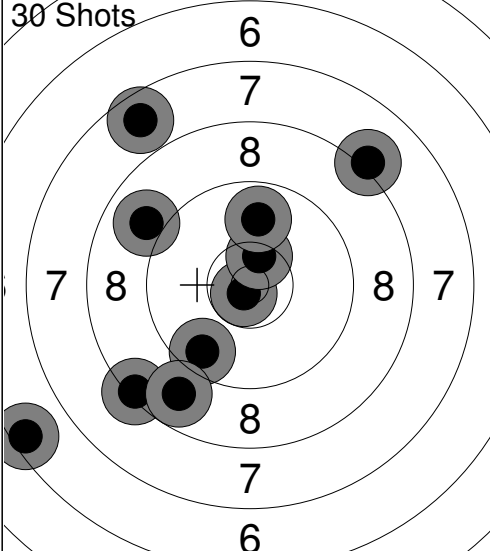
<p>30 Shots</p> 		
--	--	--

Relay 1	Lane 16	OLSEN Jesse		
-------------------	-------------------	--------------------	--	--

AHA Maple Leaf Open	SK	SR	MP
---------------------	----	----	----

03.05.2026	2026 AHA MLO MTP	Alberta Handgun Association	
------------	------------------	-----------------------------	--

Comment	Signature		
---------	-----------	--	--

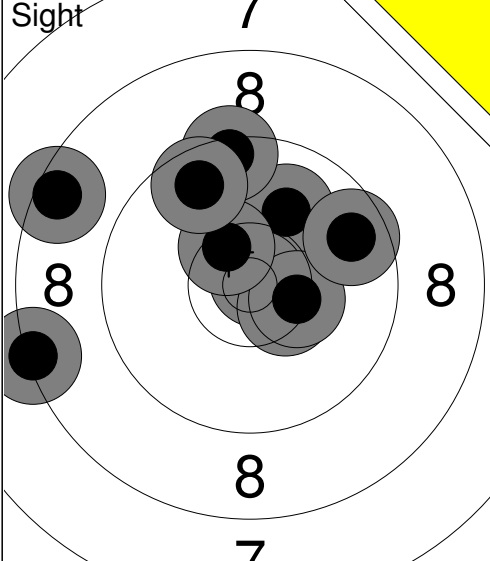
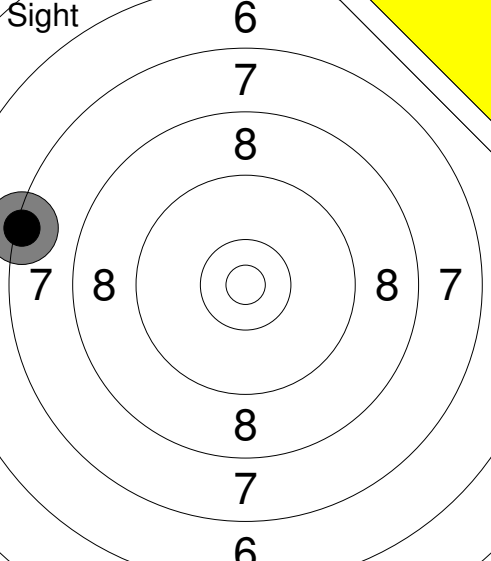
<p>Sight</p> 	<p>Sight</p> 	
---	---	--

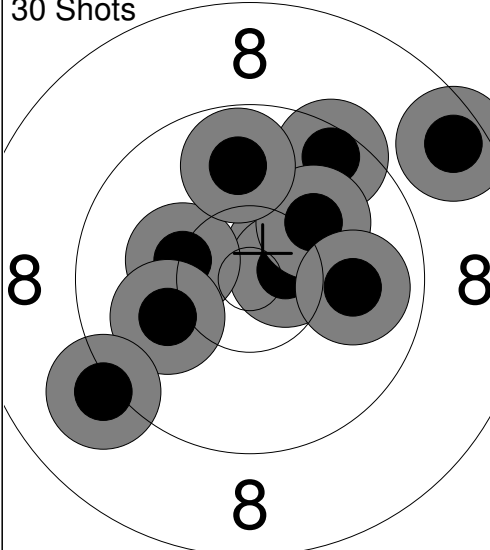
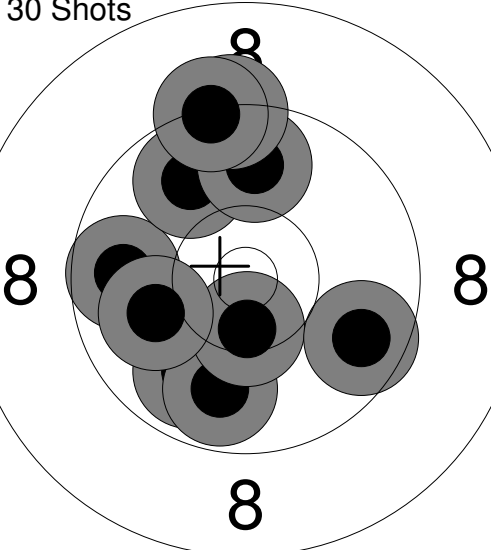
<p>30 Shots</p> 	<p>30 Shots</p> 	
---	---	--

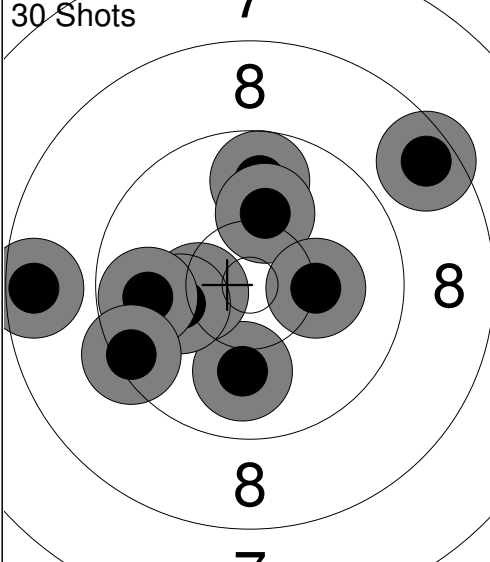
<p>30 Shots</p> 		
--	--	--

Relay 1	Lane 17	HAN Kally			
-------------------	-------------------	------------------	--	--	--

AHA Maple Leaf Open	BC	JR	WP
---------------------	----	----	----

03.05.2026	2026 AHA MLO MTP	Alberta Handgun Association
------------	------------------	-----------------------------

Comment	Signature
---------	-----------

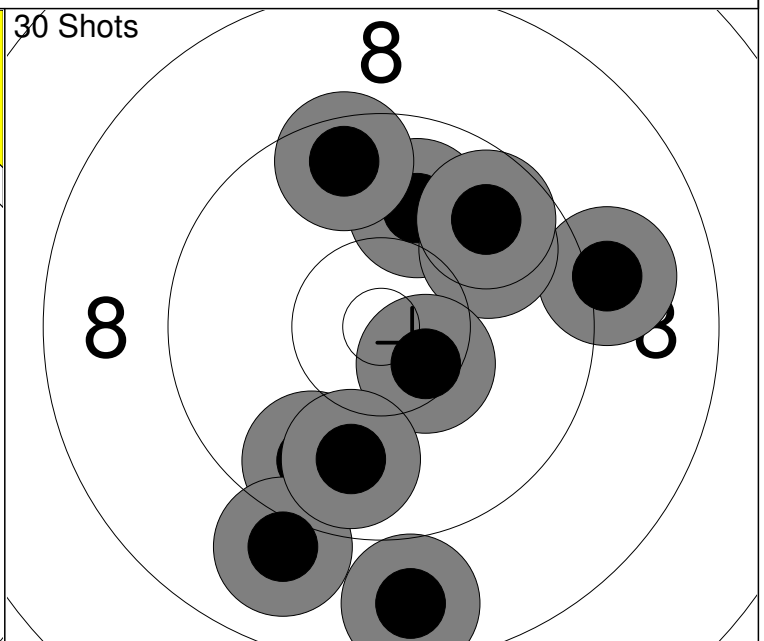
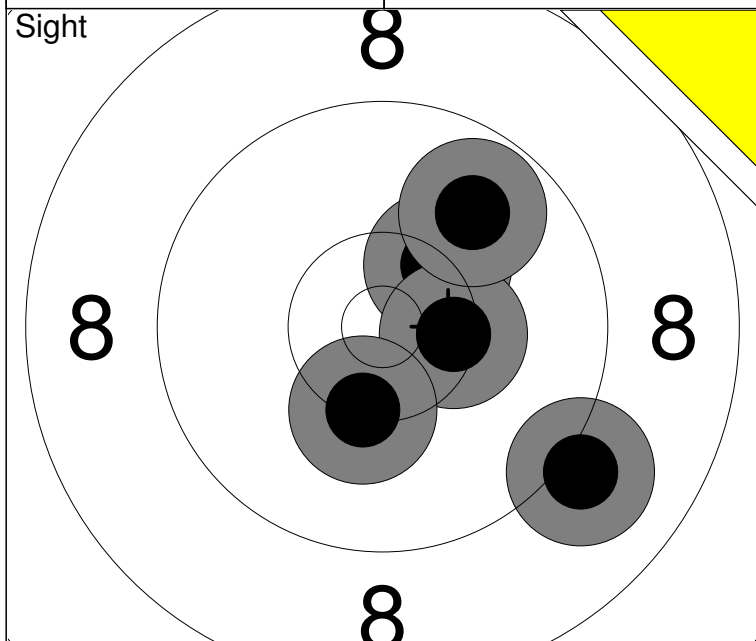

1: 10.3 ↗
2: 10.4x →
3: 9.1 ↘
4: 10.3 ↓
5: 9.8 ↗

Series	48 (1x)
	0 (0x)

1: 9.9 ↗
2: 9.1 →
3: 9.6 ↗
4: 9.7 ↓
5: 9.9 ↗

6: 8.7 ↓
7: 9.0 ↓
8: 9.7 ↗
9: 10.5x ↘
10: 9.9 ↓

Series	90 (1x)
	90 (1x)

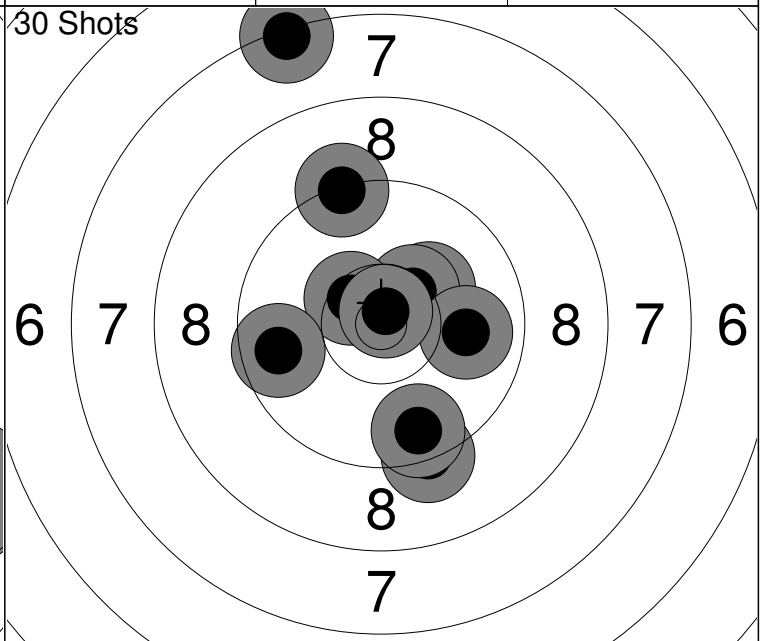
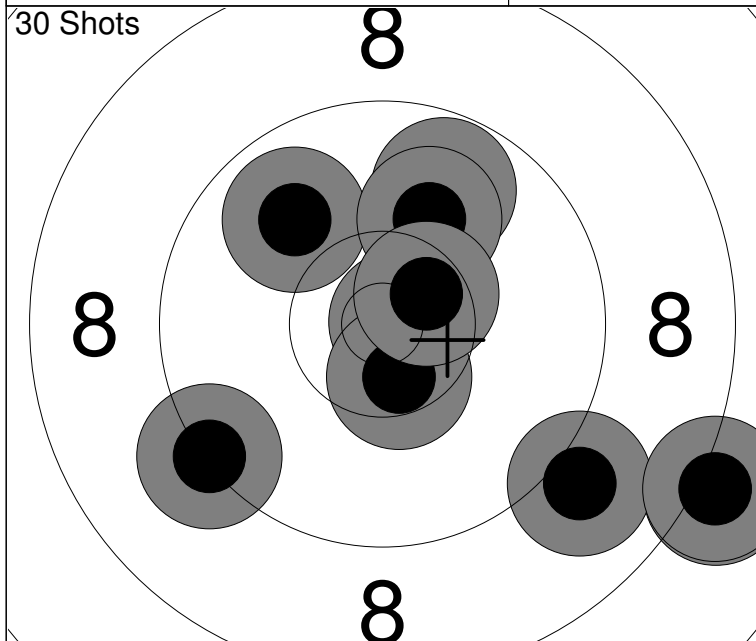

11: 8.1 ↘
12: 9.9 ↗
13: 10.8x →
14: 9.8 ↗
15: 9.0 ↘

16: 10.5x ↓
17: 10.1 ↗
18: 8.1 ↘
19: 9.3 ↙
20: 10.5x ↗

Series	92 (3x)
	182 (4x)

21: 10.2 ↗
22: 9.3 ↓
23: 7.3 ↗
24: 10.4x ↗
25: 10.5x ↙

26: 9.9 →
27: 10.8x ↗
28: 9.6 ↓
29: 9.3 ↗
30: 9.7 ←

Series	92 (3x)
	274 (7x)

Relay 1	Lane 18	KRUEGER Cameron
-------------------	-------------------	------------------------

AHA Maple Leaf Open	SK	JR	MP
---------------------	----	----	----

03.05.2026	2026 AHA MLO MTP	Alberta Handgun Association
------------	------------------	-----------------------------

Comment	Signature
---------	-----------

<p>Sight</p>	<p>1: 9.3 ← 2: 9.7 ← 3: 10.1 ↑ 4: 10.4x ↑ 5: 10.0 → 6: 8.2 ↑ 7: 7.5 ← 8: 9.9 ↓ 9: 9.8 → 10: 10.6x ←</p> <p>Series 91 (2x) 0 (0x)</p>	<p>Sight</p>	<p>11: 8.6 ↓ 12: 9.6 ← 13: 9.6 ↖</p> <p>Series 26 (0x) 0 (0x)</p>
--------------	--	--------------	---

<p>30 Shots</p>	<p>1: 10.1 ↓ 2: 9.7 ← 3: 9.2 ↓ 4: 10.6x → 5: 8.9 ← 6: 10.4x ↖ 7: 9.9 → 8: 9.6 → 9: 10.2 ↓ 10: 7.8 →</p> <p>Series 91 (2x) 91 (2x)</p>	<p>30 Shots</p>	<p>11: 9.9 ↓ 12: 9.4 ← 13: 9.5 ↑ 14: 9.9 ← 15: 9.9 ↓ 16: 9.0 → 17: 10.5x ↓ 18: 9.6 ← 19: 10.1 ← 20: 9.8 →</p> <p>Series 92 (1x) 183 (3x)</p>
-----------------	---	-----------------	--

<p>30 Shots</p>	<p>21: 8.5 ↓ 22: 9.8 ↑ 23: 10.3 ↓ 24: 10.1 → 25: 8.0 ↓ 26: 9.2 → 27: 10.5x → 28: 9.8 ↑ 29: 10.3 ↖ 30: 9.6 ←</p> <p>Series 92 (1x) 275 (4x)</p>		
-----------------	--	--	--

Comment	Signature
---------	-----------

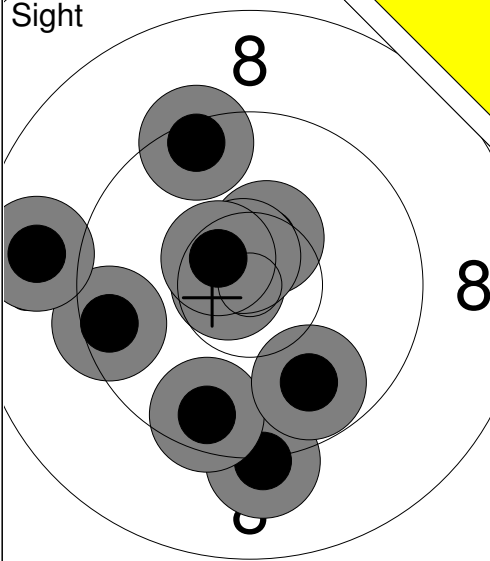
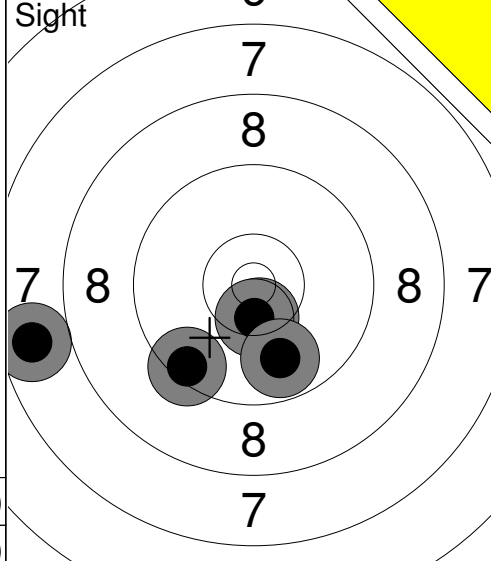
<p>Sight</p> 	<p>Sight</p> 	
---	---	--

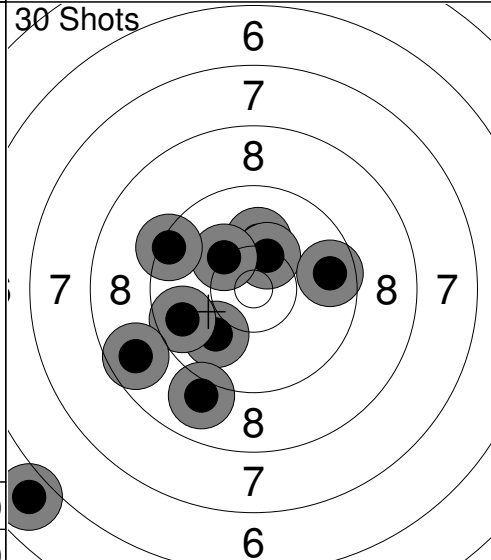
<p>30 Shots</p> 	<p>30 Shots</p> 	
---	---	--

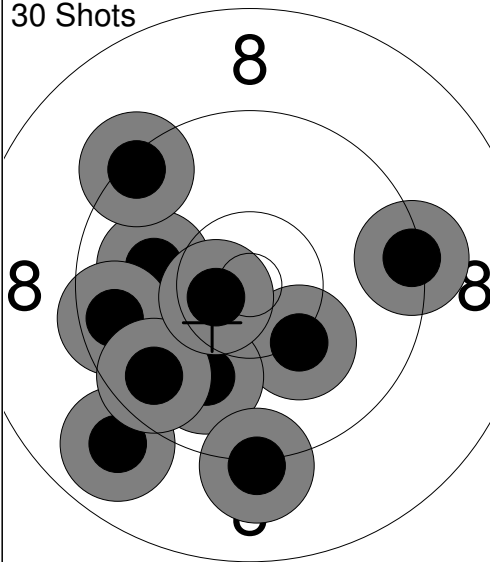
<p>30 Shots</p> 		
--	--	--

Relay 1	Lane 20	TIAN Ryan
-------------------	-------------------	------------------

AHA Maple Leaf Open	BC	JR	MP
---------------------	----	----	----

03.05.2026	2026 AHA MLO MTP	Alberta Handgun Association
------------	------------------	-----------------------------

Comment	Signature
---------	-----------

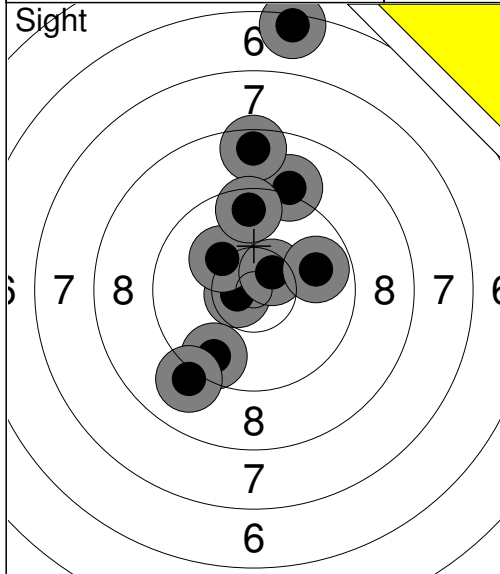

1:	10.7x	←
2:	10.2	↖
3:	9.1	↑
4:	9.6	↙
5:	10.5x	↗
6:	8.5	↑
7:	9.8	→
8:	9.6	↑
9:	6.4	↑
10:	9.1	↙
Series		89 (2x)
		0 (0x)

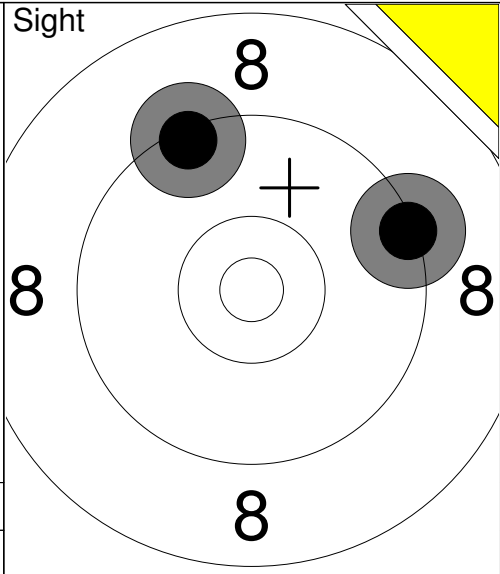

11:	9.3	→
12:	9.4	↖
Series		18 (0x)
		0 (0x)

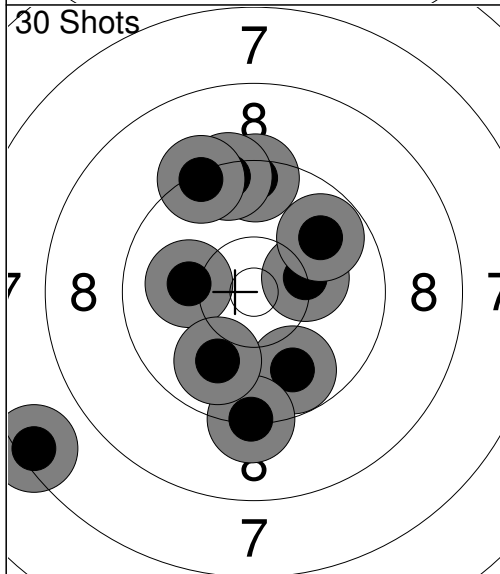

1:	10.3	→
2:	9.8	↙
3:	9.5	↑
4:	9.8	↗
5:	9.4	↑
6:	9.3	↙
7:	10.1	←
8:	7.4	←
9:	9.3	↑
10:	9.9	↙
Series		90 (0x)
		90 (0x)

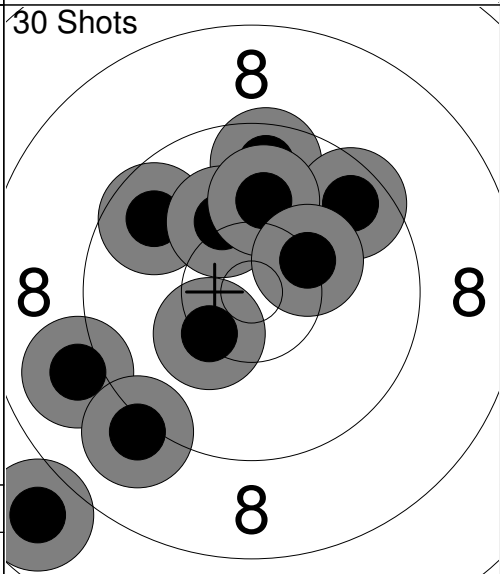

11:	10.3	↙
12:	9.6	↑
13:	9.6	↗
14:	9.0	←
15:	9.7	↖
16:	10.2	↖
17:	10.0	↑
18:	7.8	↙
19:	9.1	↙
20:	10.3	↗
Series		92 (0x)
		182 (0x)

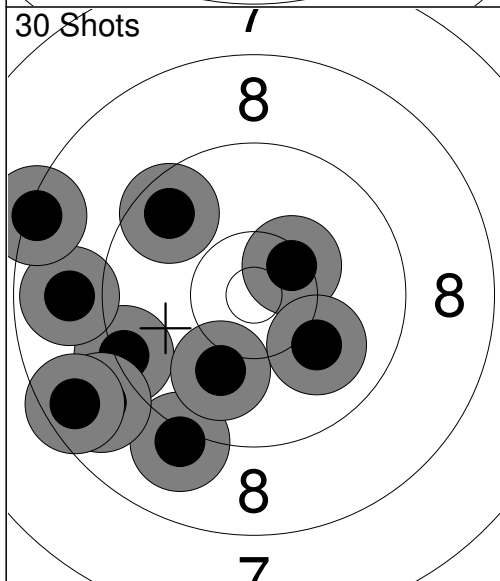

21:	9.1	↙
22:	9.3	←
23:	8.8	↙
24:	8.6	←
25:	8.9	←
26:	10.0	↙
27:	8.3	←
28:	9.6	↖
29:	10.4x	↗
30:	10.0	↙
Series		89 (1x)
		271 (1x)

Relay 1	Lane 21	BRITTON Kim
-------------------	-------------------	--------------------

AHA Maple Leaf Open	AB	SR	WP
---------------------	----	----	----

03.05.2026	2026 AHA MLO MTP	Alberta Handgun Association
------------	------------------	-----------------------------

Comment	Signature
---------	-----------

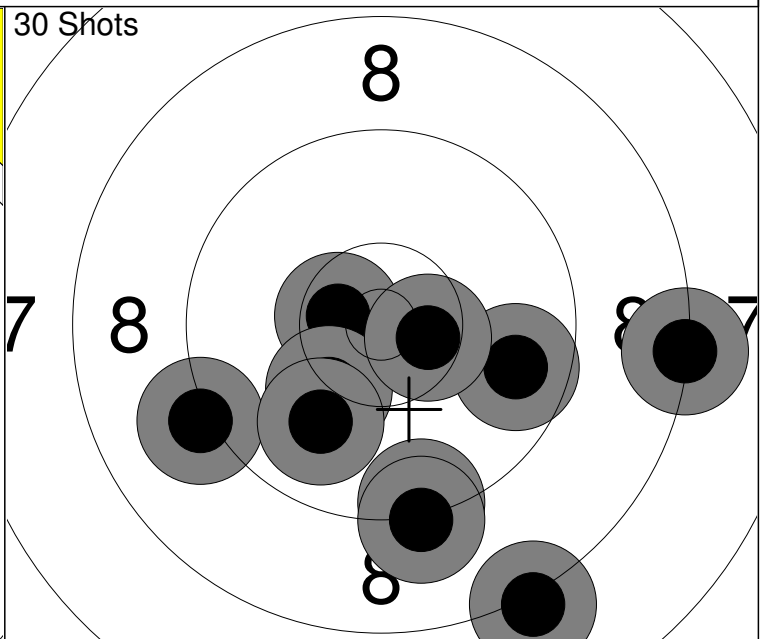
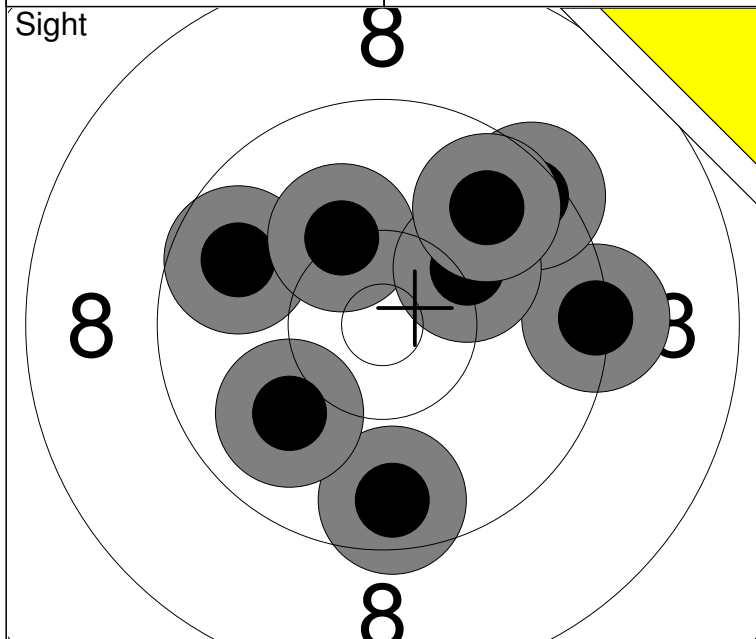

1: 9.7 ↙	6: 9.6 ↓	Series	75 (0x)
2: 9.3 →	7: 10.0 ↘		0 (0x)
3: 9.5 ↗	8: 9.8 ↗		
4: 10.2 ↗			
5: 10.2 ↗			

1: 8.1 ↓	6: 9.7 →	Series	91 (2x)
2: 10.6x ↙	7: 9.3 ↓		91 (2x)
3: 8.3 →	8: 9.9 ↘		
4: 10.2 ↓	9: 10.5x →		
5: 9.1 ↙	10: 9.2 ↓		

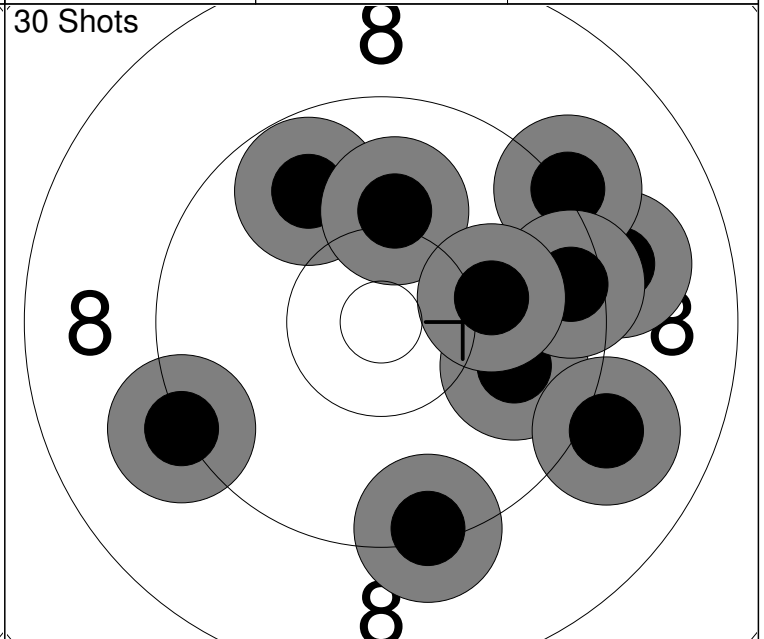
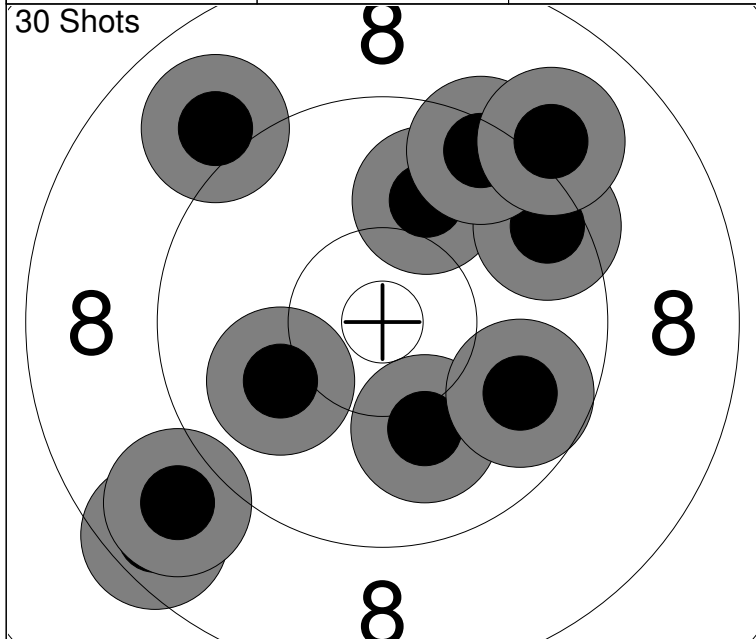

11: 10.0 ↗	16: 9.0 ↖	Series	91 (0x)
12: 9.5 ↗	17: 9.8 →		182 (2x)
13: 10.1 ↓	18: 9.1 ↗		
14: 9.4 ↗	19: 10.0 ↙		
15: 8.6 ↙	20: 8.9 ↙		

21: 9.1 →	26: 9.2 ↙	Series	92 (0x)
22: 9.3 ↓	27: 9.0 →		274 (2x)
23: 9.9 →	28: 9.8 ↗		
24: 9.2 ↗	29: 10.1 ↑		
25: 9.5 →	30: 10.1 →		

Relay **1** Lane **22** **SKJONSBURG Ryan**

AHA Maple Leaf Open AB JR MP

03.05.2026 2026 AHA MLO MTP Alberta Handgun Association

Comment Signature

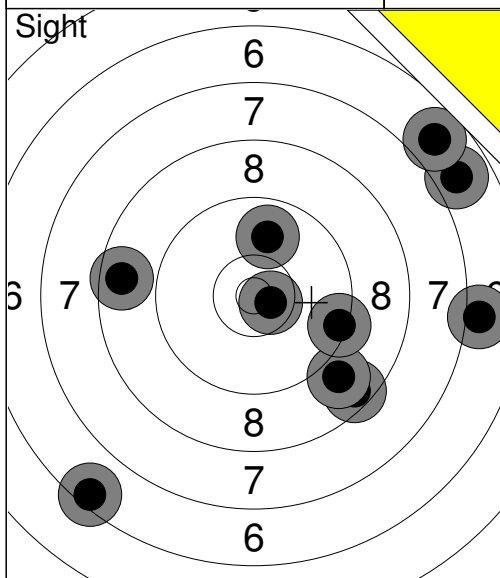

1:	6.4	↙
2:	8.5	↘
3:	9.9	↑
4:	8.9	↘
5:	8.6	←
6:	9.4	→
7:	6.8	↗
8:	10.6x	→
9:	6.8	↗
10:	7.0	→
Series	77 (1x)	
	0 (0x)	

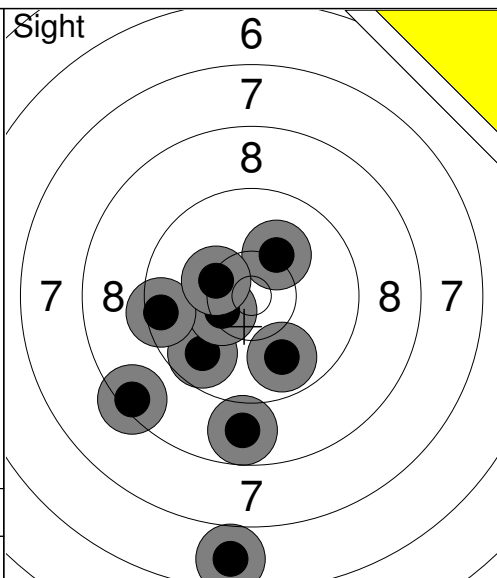

11:	9.9	↘
12:	9.7	↙
13:	10.4x	↙
14:	8.4	↙
15:	6.7	↓
16:	8.8	↓
17:	10.2	↗
18:	6.1	↗
19:	9.5	←
20:	10.3	↖
Series	85 (1x)	
	0 (0x)	

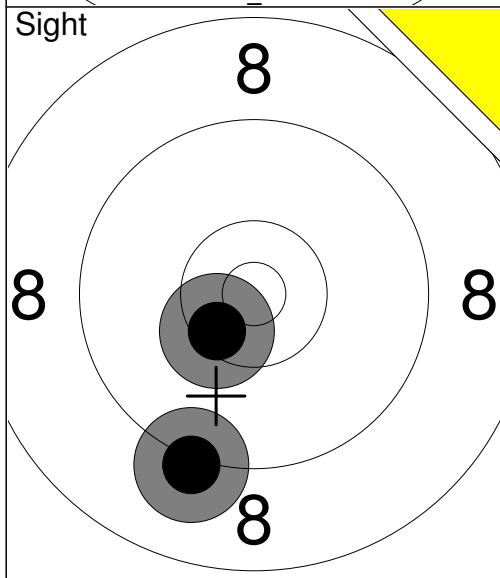

21:	9.2	↓
22:	10.4x	↙
Series	19 (1x)	
	0 (0x)	

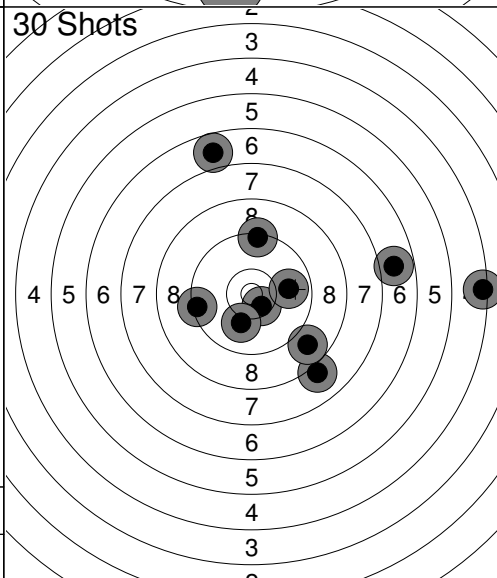

1:	10.5x	↘
2:	9.9	→
3:	10.1	↓
4:	4.3	→
5:	6.8	↑
6:	6.8	→
7:	9.4	←
8:	8.0	↘
9:	9.3	↑
10:	8.8	↘
Series	79 (1x)	
	79 (1x)	

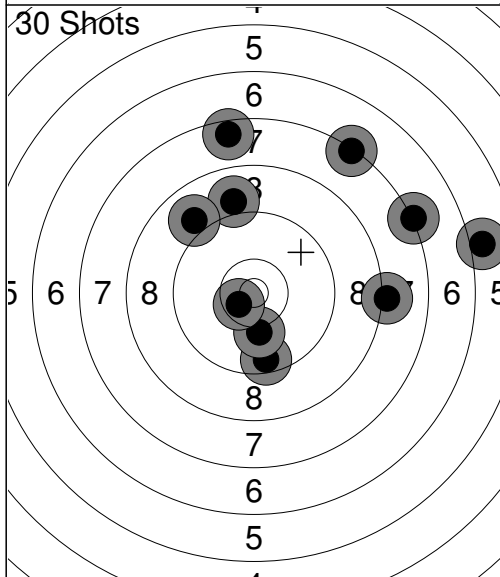

11:	9.0	↑
12:	6.0	→
13:	7.2	↗
14:	7.3	↗
15:	8.1	→
16:	8.9	↗
17:	9.5	↓
18:	10.1	↓
19:	10.5x	↙
20:	7.5	↑
Series	81 (1x)	
	160 (2x)	

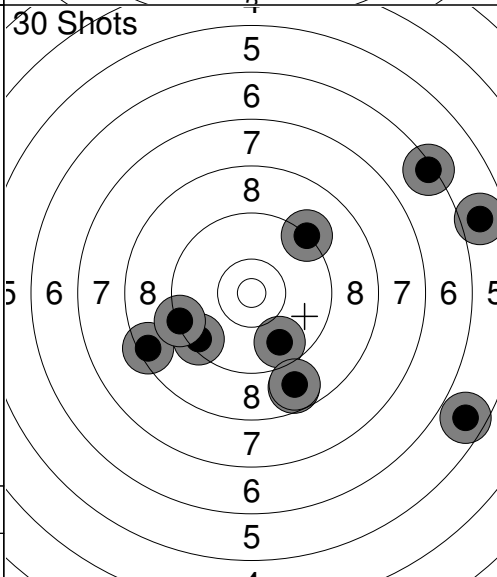

21:	8.5	↖
22:	6.4	↗
23:	9.2	↗
24:	9.7	↘
25:	5.7	↘
26:	5.8	→
27:	9.4	↙
28:	9.3	←
29:	8.7	↓
30:	8.8	↓
Series	76 (0x)	
	236 (2x)	

Relay 1	Lane 23	GUSTAFSON Elizabeth		
-------------------	-------------------	----------------------------	--	--

AHA Maple Leaf Open	AB	SR	WP
---------------------	----	----	----

03.05.2026	2026 AHA MLO MTP	Alberta Handgun Association	
------------	------------------	-----------------------------	--

Comment	Signature		
---------	-----------	--	--

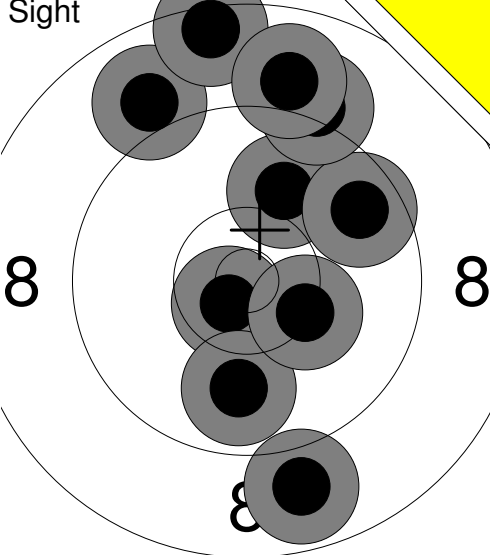
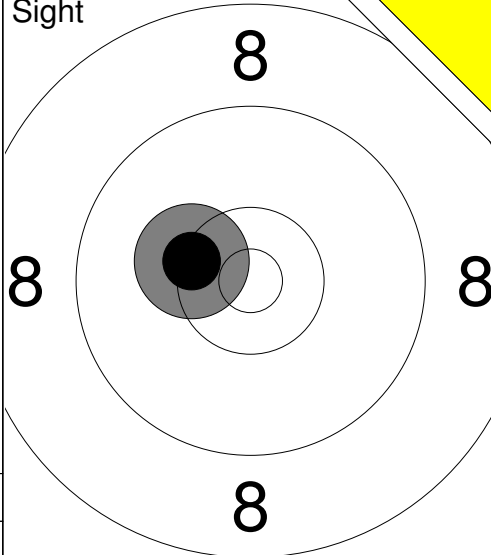
<p>Sight</p> 	<p>Sight</p> 	<p>11: 10.3 ←</p> <p>Series 10 (0x) 0 (0x)</p>
---	---	--

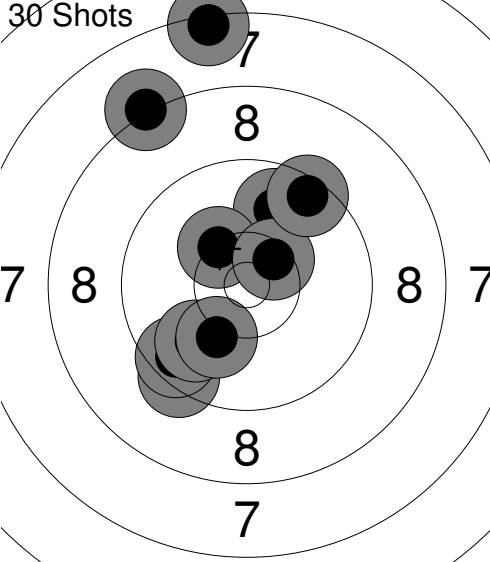
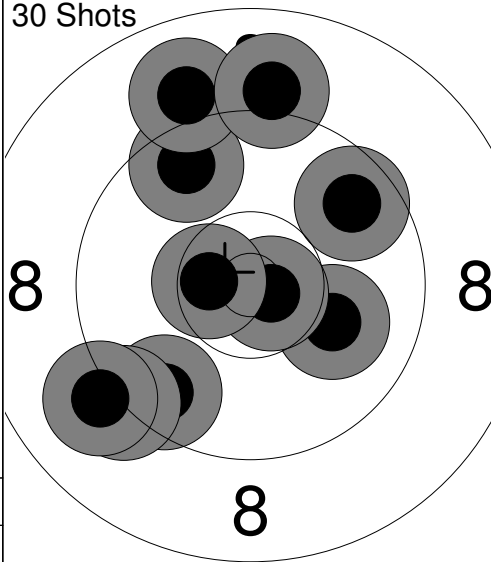
<p>30 Shots</p> 	<p>30 Shots</p> 	<p>11: 9.6 ↑ 12: 9.0 ↑ 13: 9.6 ↓ 14: 10.1 → 15: 9.0 ↑ 16: 10.7x → 17: 9.7 ↗ 18: 9.2 ↓ 19: 10.5x ← 20: 9.1 ↓</p> <p>Series 93 (2x) 183 (3x)</p>
---	---	--

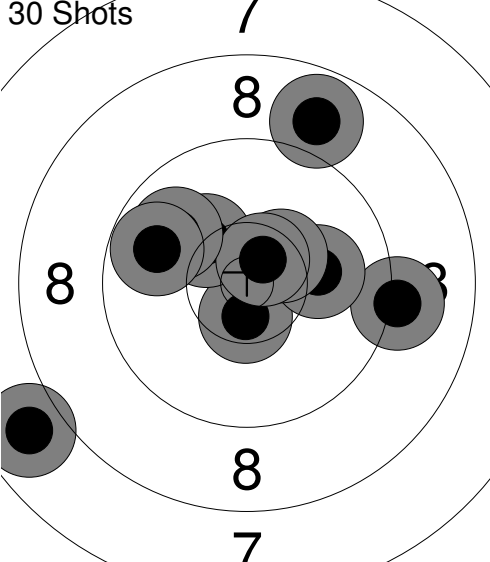
<p>30 Shots</p> 	<p>21: 10.6x ↓ 22: 9.1 → 23: 10.1 → 24: 10.3 ↖ 25: 10.4x ↗ 26: 10.6x ↗ 27: 8.9 ↑ 28: 9.9 ↖ 29: 7.8 ↓ 30: 9.8 ←</p> <p>Series 92 (3x) 275 (6x)</p>	
--	---	--

Comment	Signature		
---------	-----------	--	--

<p>Sight</p>	<p>1: 9.2 ↗ 2: 10.2 ↓ 3: 10.5x ↖ 4: 9.1 ↗ 5: 9.7 ↓ 6: 8.1 ↗ 7: 8.5 ↗ 8: 10.3 → 9: 8.6 ↑ 10: 8.2 ↗</p> <p>Series 89 (1x) 0 (0x)</p>	<p>Sight</p>	<p>11: 9.3 → 12: 9.2 ↗ 13: 8.4 → 14: 9.4 ↓ 15: 9.6 ↖</p> <p>Series 44 (0x) 0 (0x)</p>
--------------	--	--------------	---

<p>30 Shots</p>	<p>1: 10.0 → 2: 9.4 → 3: 8.5 ↓ 4: 10.7x ↓ 5: 9.6 ↑ 6: 6.3 ↗ 7: 9.7 ↓ 8: 9.2 ← 9: 9.0 ← 10: 10.6x ←</p> <p>Series 89 (2x) 89 (2x)</p>	<p>30 Shots</p>	<p>11: 9.0 ↓ 12: 9.6 ↓ 13: 9.4 ↙ 14: 8.8 ↓ 15: 10.7x ↖ 16: 10.9x → 17: 9.3 ↗ 18: 9.7 ↑ 19: 9.2 ↖ 20: 8.6 →</p> <p>Series 90 (2x) 179 (4x)</p>
-----------------	--	-----------------	---

<p>30 Shots</p>	<p>21: 10.1 ↗ 22: 10.2 ↖ 23: 10.4x ↓ 24: 10.0 ↓ 25: 10.5x ↓ 26: 8.0 ↓ 27: 9.2 ↓ 28: 8.5 ← 29: 8.5 ↑ 30: 9.5 ↗</p> <p>Series 92 (2x) 271 (6x)</p>		
-----------------	--	--	--