

Relay 1	Lane 4	KOZERA Monika
-------------------	------------------	----------------------

SFC Jr Nats (AB)	AB	JR	WP
------------------	----	----	----

28.03.2026	2026 SFC Jr Nats AB	Alberta Handgun Association
------------	---------------------	-----------------------------

Comment	Signature
---------	-----------

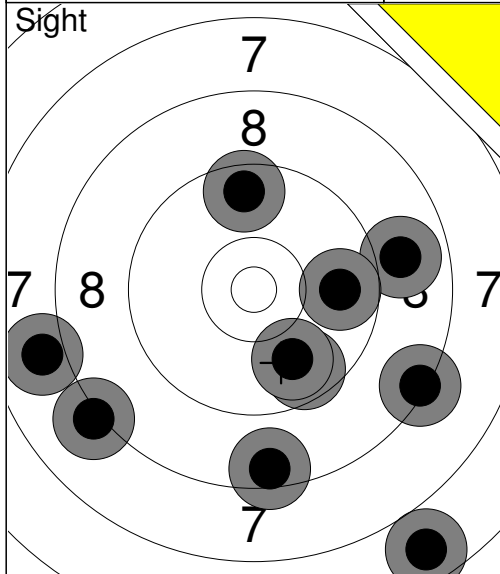

1:	9.6	↑
2:	8.1	↙
3:	7.9	←
4:	9.7	↘
5:	6.7	↘
6:	9.9	↘
7:	8.9	→
8:	9.8	→
9:	8.5	↘
10:	8.3	↘
Series	81 (0x)	
	0 (0x)	

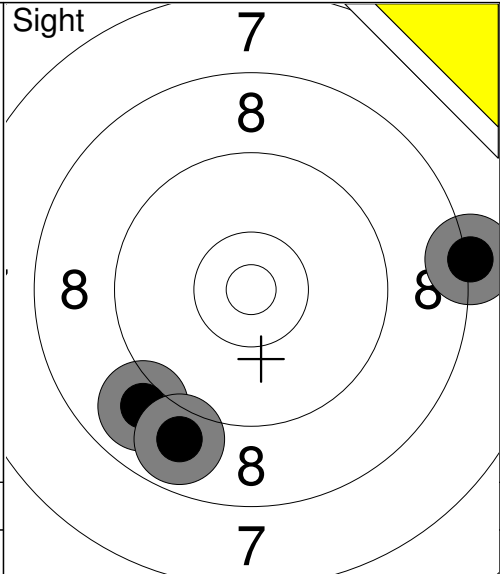

11:	8.2	→
12:	9.0	↙
13:	8.9	↘
Series	25 (0x)	
	0 (0x)	

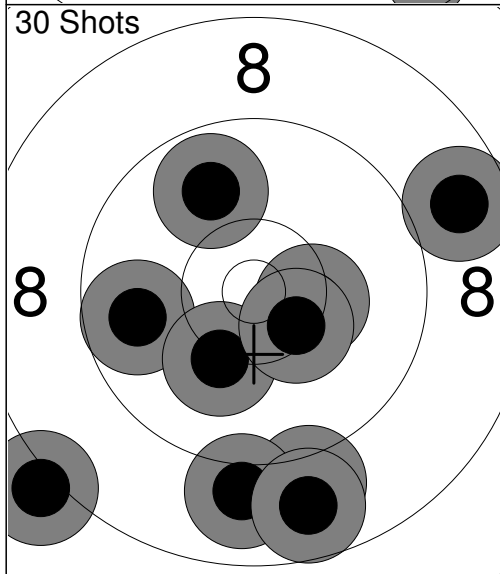

1:	8.7	→
2:	9.8	←
3:	10.4x	→
4:	9.0	↘
5:	10.2	↘
6:	10.4x	↘
7:	9.0	↘
8:	8.8	↘
9:	8.1	↙
10:	9.9	↑
Series	90 (2x)	
	90 (2x)	

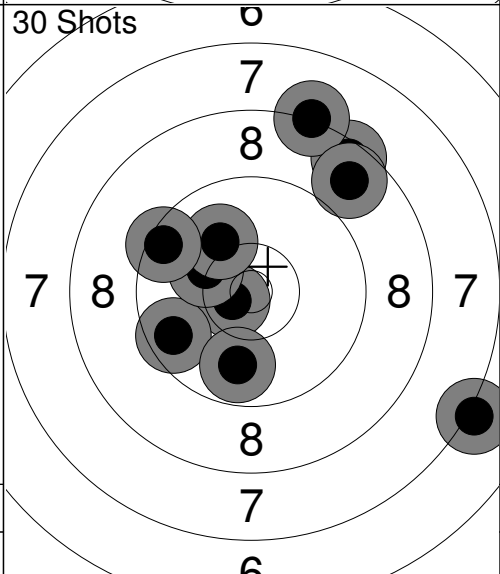

11:	7.1	↘
12:	10.6x	↙
13:	9.6	↙
14:	10.2	↙
15:	8.5	↗
16:	8.2	↗
17:	10.1	↗
18:	9.5	↙
19:	8.7	↗
20:	9.8	↘
Series	88 (1x)	
	178 (3x)	

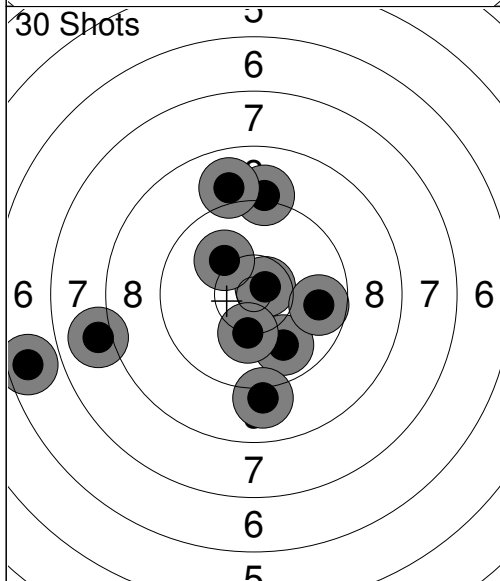

21:	10.7x	↗
22:	9.9	↘
23:	9.1	↑
24:	6.6	←
25:	10.1	↗
26:	9.0	↘
27:	10.2	↘
28:	8.0	←
29:	8.9	↑
30:	9.7	→
Series	88 (1x)	
	266 (4x)	

Relay 1	Lane 5	ZHAO William		
-------------------	------------------	---------------------	--	--

SFC Jr Nats (AB)	AB	JR	MP
------------------	----	----	----

28.03.2026	2026 SFC Jr Nats AB	Alberta Handgun Association	
------------	---------------------	-----------------------------	--

Comment	Signature
---------	-----------

	1: 9.4 ← 2: 6.2 → 3: 10.0 ↓ 4: 7.7 ↓ 5: 6.6 ↓ 6: 0.0 ← 7: 6.2 ↓ 8: 3.2 ← 9: 8.3 → 10: 3.8 ↓ Series 58 (0x) 0 (0x)		11: 3.6 ↓ 12: 8.1 ↗ 13: 6.9 ↖ 14: 6.6 ↖ 15: 7.8 ↗ Series 30 (0x) 0 (0x)
--	--	--	---

	1: 10.1 → 2: 7.4 ↗ 3: 10.3 → 4: 10.4x ← 5: 9.3 ← 6: 8.2 ↗ 7: 0.0 ← 8: 7.0 ↖ 9: 9.2 ↓ 10: 6.9 → Series 76 (1x) 76 (1x)		11: 10.0 ↖ 12: 7.8 ← 13: 9.1 ↓ 14: 8.8 ↓ 15: 6.3 ↗ 16: 7.1 ← 17: 3.3 ↓ 18: 7.4 ↓ 19: 4.5 ↓ 20: 5.7 ↘ Series 66 (0x) 142 (1x)
--	--	--	---

	21: 6.6 ↖ 22: 6.5 ↓ 23: 6.7 → 24: 8.3 ↘ 25: 6.9 ↓ 26: 8.2 ↗ 27: 7.9 ← 28: 7.8 ↓ 29: 6.4 ↓ 30: 7.4 ← Series 67 (0x) 209 (1x)
--	--

Relay **1** Lane **6** **PENG Xinyao**

SFC Jr Nats (AB) AB JR WP

28.03.2026 2026 SFC Jr Nats AB Alberta Handgun Association

Comment Signature

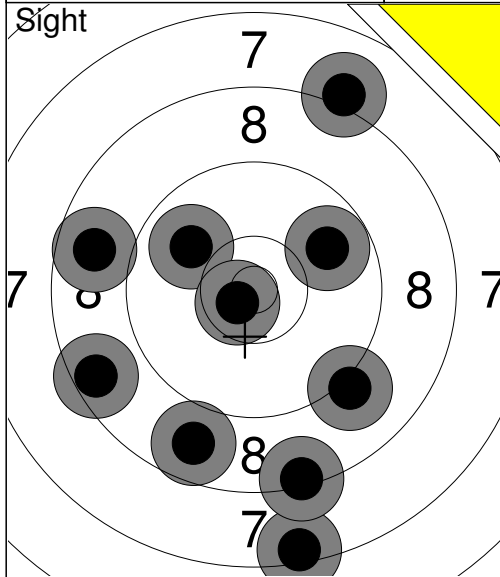

1:	8.5	↙
2:	9.8	↗
3:	8.7	↘
4:	7.4	↘
5:	8.7	↙
6:	8.1	↗
7:	9.1	↘
8:	8.3	↘
9:	9.9	↗
10:	10.7x	↙
Series	84 (1x)	
	0 (0x)	

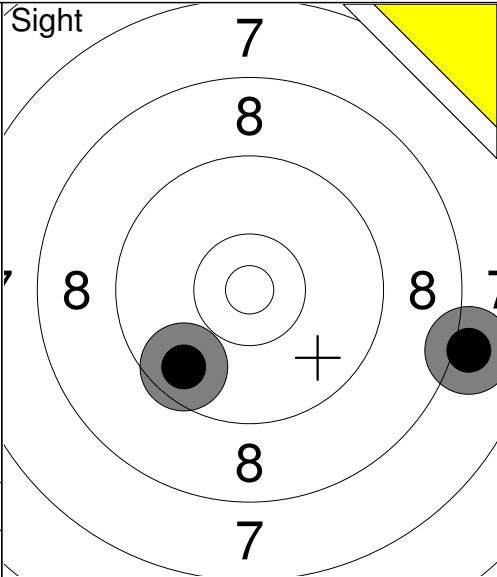

11:	8.0	↗
12:	9.7	↙
Series	17 (0x)	
	0 (0x)	

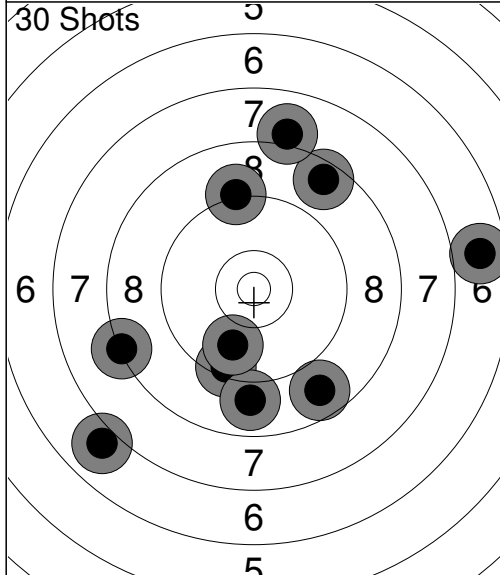

1:	9.4	↘
2:	8.6	↗
3:	8.7	↘
4:	6.9	↙
5:	8.9	↘
6:	8.3	↙
7:	9.2	↗
8:	8.0	↗
9:	6.7	↗
10:	9.8	↘
Series	79 (0x)	
	79 (0x)	

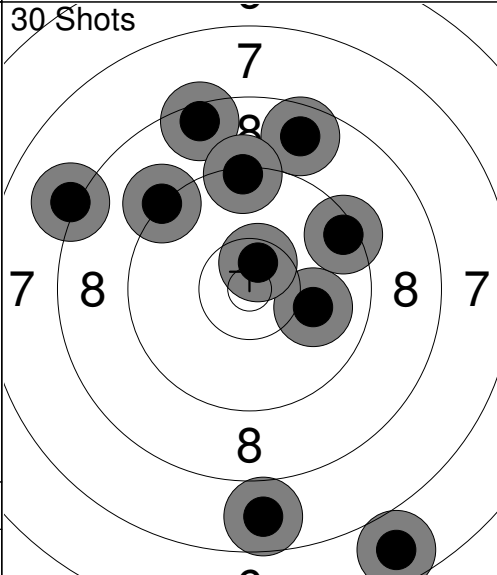

11:	10.0	↗
12:	7.7	↘
13:	8.5	↗
14:	6.7	↘
15:	8.1	↙
16:	9.4	↗
17:	9.2	↙
18:	8.7	↗
19:	10.6x	↗
20:	9.3	↗
Series	84 (1x)	
	163 (1x)	

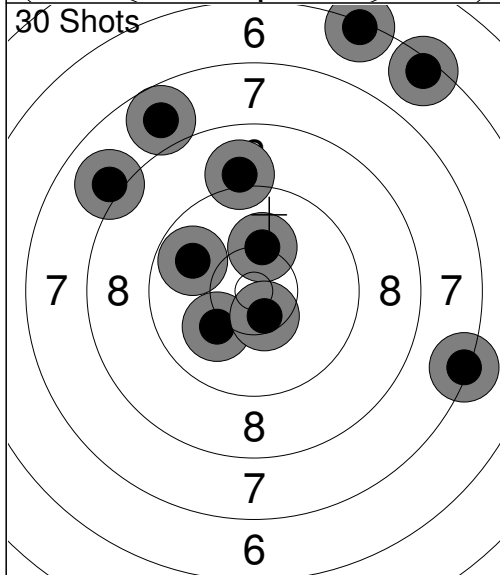

21:	7.8	↗
22:	10.2	↗
23:	9.8	↙
24:	8.0	↙
25:	10.1	↙
26:	6.4	↗
27:	6.3	↗
28:	10.5x	↘
29:	9.0	↗
30:	7.3	↗
Series	82 (1x)	
	245 (2x)	

Relay **1** Lane **7** **CHAN Kaspar**

SFC Jr Nats (AB) AB JR MP

28.03.2026 2026 SFC Jr Nats AB Alberta Handgun Association

Comment Signature

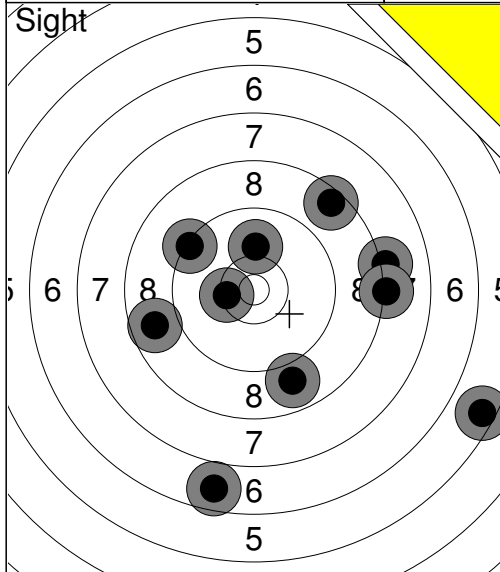

1:	8.1	→
2:	9.3	↗
3:	5.5	→
4:	10.4x	←
5:	8.9	↓
6:	8.5	↗
7:	10.0	↑
8:	8.7	←
9:	8.2	→
10:	6.7	↓
Series	80 (1x)	
	0 (0x)	

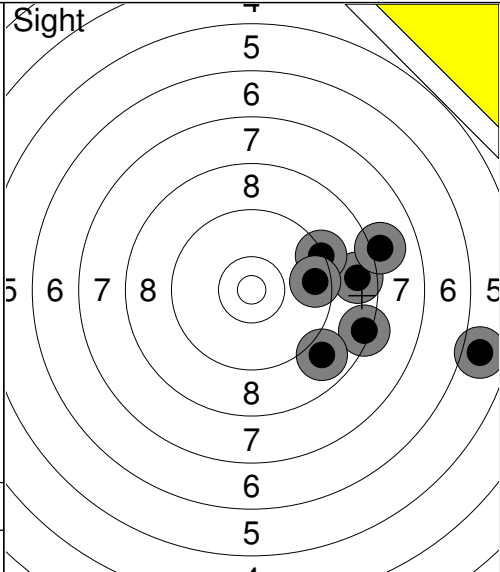

11:	8.7	→
12:	5.9	→
13:	8.4	→
14:	9.3	↗
15:	9.6	→
16:	8.0	→
17:	8.9	↓
Series	55 (0x)	
	0 (0x)	

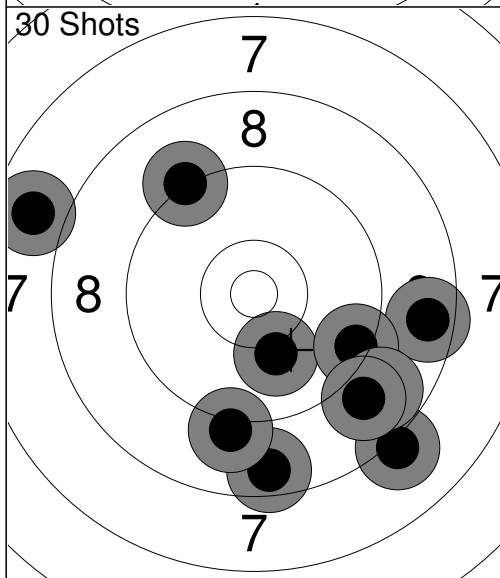

1:	7.8	←
2:	8.6	→
3:	8.1	↘
4:	8.6	↓
5:	10.1	↓
6:	9.2	↗
7:	9.1	↓
8:	9.4	↘
9:	8.8	↘
10:	8.9	↘
Series	84 (0x)	
	84 (0x)	

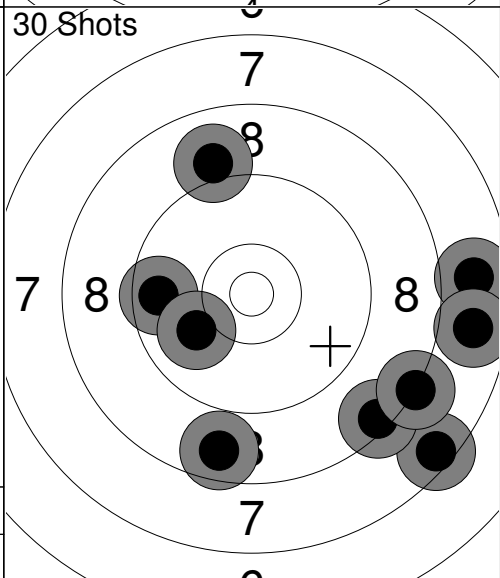

11:	8.2	↘
12:	9.0	↑
13:	9.6	←
14:	7.8	→
15:	7.5	↘
16:	7.7	→
17:	10.0	←
18:	8.4	↘
19:	8.2	↘
20:	8.7	↓
Series	81 (0x)	
	165 (0x)	

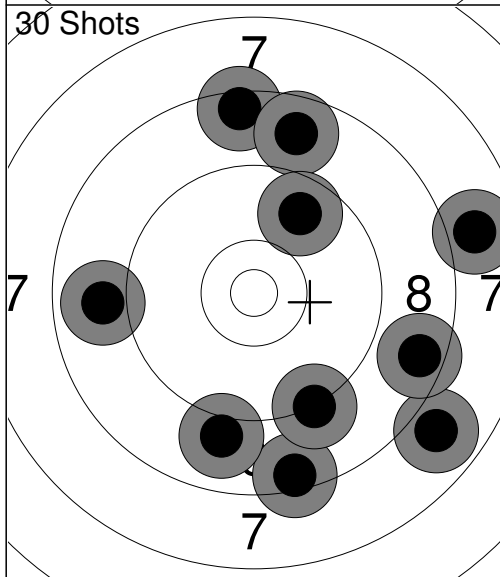

21:	7.9	↘
22:	8.9	←
23:	8.4	↓
24:	8.5	↑
25:	8.7	↑
26:	9.7	↗
27:	9.0	↓
28:	9.2	↓
29:	8.6	→
30:	7.9	→
Series	81 (0x)	
	246 (0x)	

Relay 1	Lane 8	AHLUWALIA Gurleen
-------------------	------------------	--------------------------

SFC Jr Nats (AB)	AB	JR	WR
------------------	----	----	----

28.03.2026	2026 SFC Jr Nats AB	Alberta Handgun Association
------------	---------------------	-----------------------------

Comment	Signature
---------	-----------

<p>Sight</p> <p style="text-align: center;">6</p>	<p>1: 10.1 ←</p> <p>2: 10.4x ←</p> <p>3: 10.3x ←</p> <p>4: 9.6 ↓</p> <p>5: 9.8 ↖</p> <p>6: 9.6 ↓</p> <p>7: 10.2x ↑</p> <p>8: 9.7 →</p> <p>9: 9.1 ↑</p> <p>10: 10.1 →</p> <p>Series 98.9</p> <p style="text-align: right;">0.0</p>	<p>Sight</p> <p style="text-align: center;">6</p>	<p>11: 10.0 →</p> <p>12: 10.2x →</p> <p>13: 9.8 →</p> <p>14: 10.6x ↗</p> <p>15: 9.8 ↓</p> <p>16: 9.5 ↑</p> <p>17: 10.3x →</p> <p>18: 10.8x ↑</p> <p>Series 81.0</p> <p style="text-align: right;">0.0</p>
---	---	---	---

<p>30 Shots</p> <p style="text-align: center;">6</p>	<p>1: 9.4 →</p> <p>2: 8.2 →</p> <p>3: 10.2x ↓</p> <p>4: 8.7 ↑</p> <p>5: 9.9 ↑</p> <p>6: 10.4x ↗</p> <p>7: 9.8 ↓</p> <p>8: 10.0 →</p> <p>9: 9.4 ↑</p> <p>10: 9.8 ↖</p> <p>Series 95.8</p> <p style="text-align: right;">95.8</p>	<p>30 Shots</p> <p style="text-align: center;">6</p>	<p>11: 9.9 ↑</p> <p>12: 10.0 ↓</p> <p>13: 10.3x ↓</p> <p>14: 9.8 ↑</p> <p>15: 9.8 ↓</p> <p>16: 9.5 →</p> <p>17: 10.5x ↗</p> <p>18: 9.9 →</p> <p>19: 9.9 ↘</p> <p>20: 10.3x ↖</p> <p>Series 99.9</p> <p style="text-align: right;">195.7</p>
--	---	--	---

<p>30 Shots</p> <p style="text-align: center;">6</p>	<p>21: 10.3x ↓</p> <p>22: 10.2x →</p> <p>23: 8.7 ↓</p> <p>24: 10.9x →</p> <p>25: 10.3x ↑</p> <p>26: 10.0 ↓</p> <p>27: 9.7 →</p> <p>28: 10.2x ↗</p> <p>29: 9.9 ↓</p> <p>30: 10.6x ↗</p> <p>Series 100.8</p> <p style="text-align: right;">296.5</p>		
--	--	--	--

Relay **1** Lane **9** **SENADHEERA Lavindu**

SFC Jr Nats (AB) AB JR MR

28.03.2026 2026 SFC Jr Nats AB Alberta Handgun Association

Comment Signature

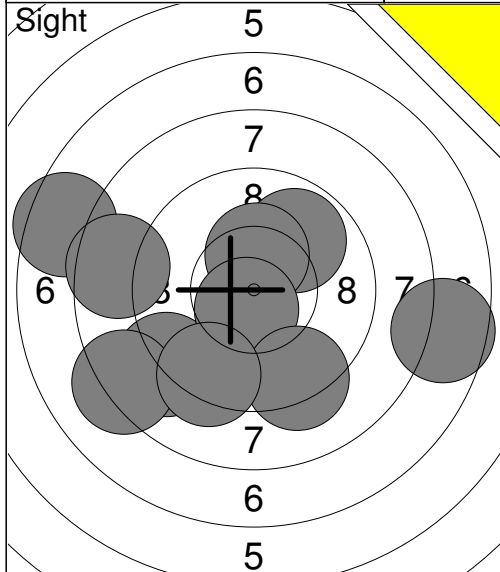

1:	9.9	↗
2:	10.3x	↑
3:	9.0	↙
4:	7.5	↖
5:	10.6x	↘
6:	8.2	↖
7:	8.6	↖
8:	7.6	→
9:	9.3	↘
10:	9.3	↘
Series	90.3	
	0.0	

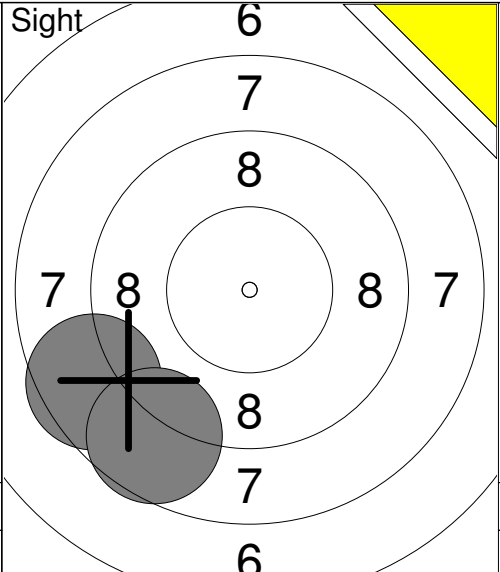

11:	8.6	↙
12:	8.6	↙
Series	17.2	
	0.0	

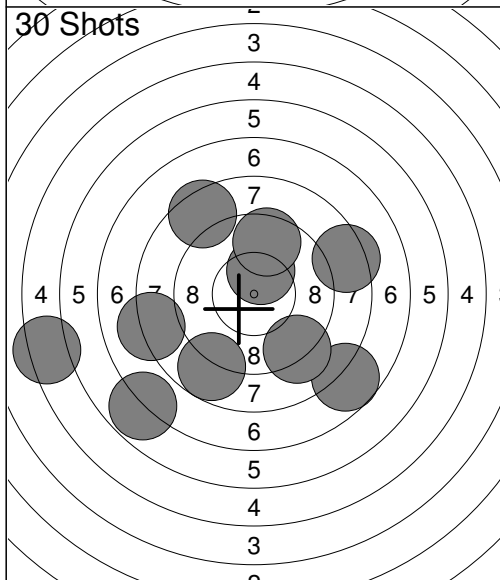

1:	5.3	↖
2:	7.7	↘
3:	6.8	↙
4:	8.4	→
5:	9.1	↘
6:	8.4	↗
7:	8.7	↘
8:	10.3x	↗
9:	8.1	↖
10:	9.5	↗
Series	82.3	
	82.3	

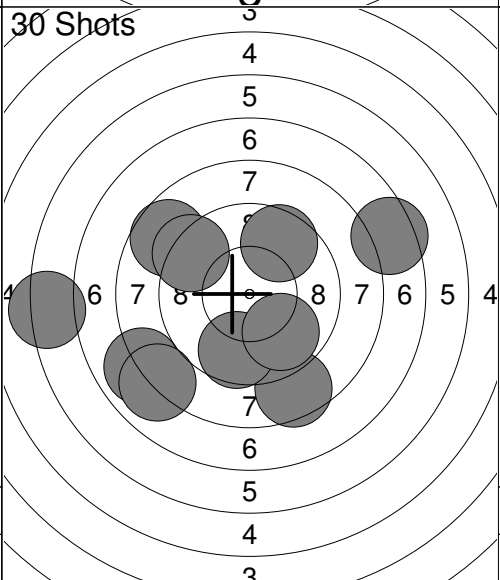

11:	9.6	↗
12:	8.5	↘
13:	7.9	↖
14:	9.6	↘
15:	6.2	↖
16:	9.8	↘
17:	8.7	↖
18:	8.0	↖
19:	7.4	→
20:	9.3	↖
Series	85.0	
	167.3	

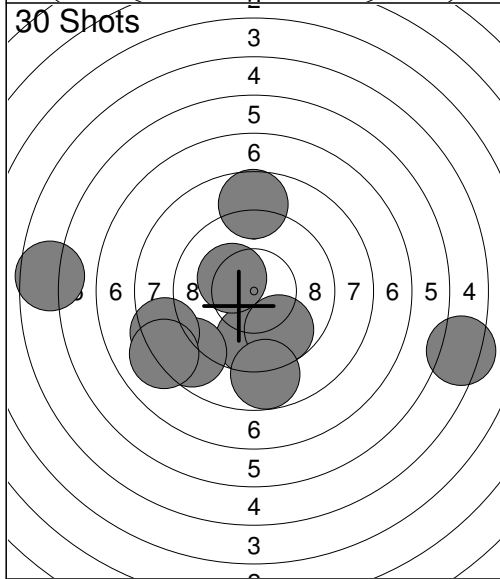

21:	5.3	→
22:	9.7	↘
23:	8.7	↑
24:	10.3x	↖
25:	9.7	↘
26:	8.7	↖
27:	8.8	↘
28:	8.4	↖
29:	8.1	↖
30:	5.6	↖
Series	83.3	
	250.6	